

CAT 4660

Parflex Thermoplastic & Fluoropolymer
Products Hose, Tubing, & Fittings Catalog 2020
Updated October 2, 2023



ENGINEERING YOUR SUCCESS.

Extra care is taken in the preparation of this literature but Parker is not responsible for any inadvertent typographical errors or omissions. Information subject to change without notice. The information in this catalog is only accurate as of the date of publication. For a more current information base, please consult the Parflex® Division web site at www.parker.com/pfd.



FAILURE OR IMPROPER SELECTION OR IMPROPER USE OF THE PRODUCTS AND/OR SYSTEMS DESCRIBED HEREIN OR RELATED ITEMS CAN CAUSE DEATH, PERSONAL INJURY AND PROPERTY DAMAGE.

This document and other information from Parker Hannifin Corporation, its subsidiaries and authorized distributors provide product and/or system options for further investigation by users having technical expertise. It is important that you analyze all aspects of your application and review the information concerning the product or system in the current product catalog. Due to the variety of operating conditions and applications for these products or systems, the user, through its own analysis and testing, is solely responsible for making the final selection of the products and systems and assuring that all performance, safety and warning requirements of the application are met. The products described herein, including without limitation, product features, specifications, designs, availability and pricing, are subject to change by Parker Hannifin Corporation and its subsidiaries at any time without notice.

Offer of Sale

The items described in this document are hereby offered for sale by Parker Hannifin Corporation, its subsidiaries or its authorized distributors. This offer and its acceptance are governed by the provisions stated in the "Offer of Sale".

©2023 Parker Hannifin Corporation, All Rights Reserved



Parflex is
known globally
for innovation,
leadership and
problem solving.

Welcome to Parflex

Hose

Thermoplastic
Fluoropolymer

Tubing

Thermoplastic
Fluoropolymer

Coils

Thermoplastic
Fluoropolymer

Heat Shrink

Fluoropolymer

Fittings

Permanent Crimp
Field Attachable

Table of Contents

A Hose

INTRO

Introduction 1

B Tubing
Thermoplastic

HOSE A

Table of Contents A-2
 Visual Index A-4
 Introduction/Technical Data A-7
 Thermoplastic A-32
 Fluoropolymer A-69

NOMENCLATURE

Thermoplastic Hose A-29
 PTFE Hose A-30

C Coiled Air Hose
& Fittings

TUBING B

Table of Contents B-2
 Introduction/Technical Data B-4
 Thermoplastic B-20
 Fluoropolymer B-44

TECHNICAL

Tubing Specifications B-6
 Tubing Pressures B-7
 Tubing - Materials Overview B-4
 Tubing Compatibility Chart-Fittings B-8
 Tubing - Materials Compatibility B-10

D Transportation

COILED AIR HOSE C

Table of Contents C-2
 Introduction/Technical Data C-3
 Fast-Stor® Air Hose C-4
 Fluoropolymer Air Hose C-8

F Tooling, Equipment,
& Accessories

G General Technical

TECHNICAL

Agency Specifications A-7
 PTFE Hose Chemical Resistance A-8
 Hose Construction A-9
 Construction Specifications A-10
 Selection of Hose Diameter A-18
 Calculation of Hose Length A-19
 Hose Material Features A-20
 Hose Material Overview A-21
 Compatibility Guide Media/Hose Mat'l A-22
 Volumetric Expansion of Hose A-26
 Selection, Installation, Maintenance A-27

NOMENCLATURE

Nylon Tubing B-14
 Polyurethane Tubing B-14
 Polyethylene Tubing B-15
 Polypropylene Tubing B-15
 Vinyl Tubing B-15
 Fluoropolymer Tubing B-16
 Convoluted Tubing B-17
 Corrugated Tubing B-17
 Heat Shrink Tubing B-18
 PTFE Beading B-19
 Spiral Wrap Tubing B-19

TRANSPORTATION D

Table of Contents D-2
 Introduction/Technical Data D-3
 Tubing D-5
 DEF Hose D-12



Table of Contents

FITTINGS E

Table of Contents E-3
 Field Attachable E-22
 Permanent Crimp E-33

NOMENCLATURE

Field Attachable/Permanent Crimp..... E-3

TECHNICAL

Fitting Configurations..... E-5
 Sanitary Sizing (PAGE Series) E-6
 Pressure Rating-Hose End Connections.....E-8
 Hose Fitting Insertion ValuesE-10
 Identifying Fitting TypesE-11
 Determining Thread TypeE-12
 German DIN Hose Fittings.....E-13
 British Standard Pipe.....E-14
 North American Thread TypesE-15
 Japanese FittingsE-17
 Fitting Thread Guide for Hose..... E-18
 Media to FittingE-20
 Metals Corrosion Scale.....E-21

TOOLING F

Table of Contents F-2
 Crimpers F-4
 AccessoriesF-15

GENERAL TECHNICAL G

Table of ContentsG-2

CRIMP INSTRUCTIONS

Permanent Crimp G-4
 Series 54, 56, CG, 92, CY, MS, SF
 Field AttachableG-8
 Series 51, 51R, BU, MS
 PTFE Permanent Crimp.....G-9
 Series 91, 91N, 93N
 PTFE Permanent Crimp.....G-11
 Series PAGE
 PTFE Field Attachable..... G-13
 Series 90
 Sewer Hose Swaging G-15
 Twin/Multi-Line Separation G-17

SAFETY / WARRANTIES

Parker Safety Guide G-19
 Enerpac Warranty.....G-23
 Offer of Sale.....G-24

INDEX

By part number G-26
 By keyword.....G-29

A Hose

B Tubing Thermoplastic

C Coiled Air Hose & Fittings

D Transportation

E Fittings

F Tooling, Equipment & Accessories

G General Technical

Parflex®

Partner. Innovator. Leader.

Parflex is a global leader in hose and tubing solutions for extreme applications.



Our Global Footprint

As part of the Parker Fluid Connectors Group, the Parflex Division is responsible for the design and manufacture of hoses and tubing to handle extreme applications. Products include thermoplastic and fluoropolymer hose and tubing, hose bundles, harnesses and accessories.

The Parflex Division includes the Ravenna, OH headquarters and manufacturing facilities in:

- Manistowoc, WI
- Fort Worth, TX
- Mansfield, TX
- Stafford, TX
- Randleman, NC
- Monterrey, Mexico
- Huttenfeld, Lampertheim, Germany - sister division, ***polyflex***

Tap Into Our Resources

In our state-of-the-art Polymer Innovation Center, driven by the single purpose of finding solutions to your most demanding fluid connector requirements. Abrasion, chemical compatibility, purity and permeation are just a few of the challenges our engineers work on everyday.

The Polymer Innovation Center is your portal to an array of solution-driven abilities and assets, all conveniently situated within a single organization.



What's New

The biggest change to the catalog is in structure.

Now each chapter also includes the technical data for those products. For example, the General Technical section hose charts have been moved to Hose, tubing charts to Tubing and fitting charts to Fittings. Also, in the Fitting section, fittings are broken up into a Field Attachable section and a Crimp section.

And, like always, the product information was updated where applicable.

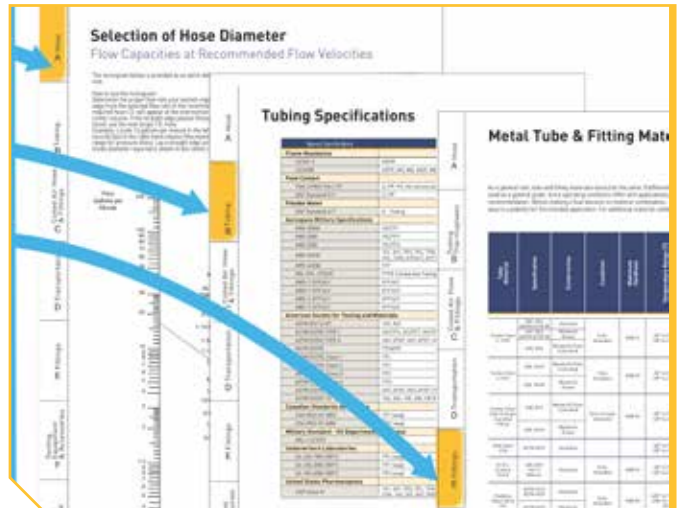

A
Hose

B
Tubing
Thermoplastic

C
Coiled Air Hose
& Fittings

D
Transportation

E
Fittings

F
Tooling, Equipment
& Accessories

G
General Technical

What's Different With A Parflex Hose

For one thing, the reputation that precedes it.

Our reputation for being a problem solver in extreme hose applications can be traced to our ability to partner with our customers and become an extension of their engineering department rather than just another supplier.



For another thing, Parflex hoses are:

- more compact without reducing flow
- more flexible without compromising strength
- lighter without diminishing performance
- and can handle a very wide range of temperatures and working pressures

Hose

Hose & Fittings Highlights

- Parflex thermoplastic hoses are lightweight with weights up to 70% lighter than competitive constructions. Thermoplastic constructions also offer a compact O.D. (30%-70% smaller) and a low length change under pressure (as low as +/- 1%).
- Rapid Assembly fittings are available to improve installation time with hoses up to 3000 psi that are qualified with 56-series fittings such as 53DM and 518D.
- TOUGHJACKET (TJ) hoses deliver 650x more abrasion resistance than standard rubber equivalents. After 143 hours of testing, the TJ hose jacket was still intact. Unfortunately, the competitive hose didn't fair as well. The internal wire reinforcements were breaking through.
- Our low temperature hoses operate in temperatures as low as -70°F/-57°C (depending on series) with no embrittlement or added stress to the core tube.



Advantages of Formed & Bonded Hoses - Why They Contribute to Your Bottom Line

- Cleaner Routings, decreasing maintenance time
- Weight reduction compared to conventional rubber and steel lines
- Reduced labor cost through quick and easy install
- Rigid but flexible, eliminating misalignment issues of steel tube equivalent
- Minimized leak points by eliminating thread joints and hose-tube combinations
- Reduced abrasion issues, increasing hose life compared to conventional rubber hose
- Reduced inventory components by eliminating clamps and/or single assemblies



A Hose

B Tubing Thermoplastic

C Coiled Air Hose & Fittings

D Transportation

E Fittings

F Tooling, Equipment & Accessories

G General Technical

Thermoplastic Hose Advantages

Parker Parflex offers an extensive selection of high-quality thermoplastic and fluoropolymer hose and tubing, fittings and accessory solutions for “extreme” applications. We specialize in designing products to meet specific needs for increased profitability and efficiency.

Long Lengths

- In some product lines, continuous lengths up to 3,500 meters (11,484 feet) are available.



Bonded Hose

- Parflex bonded assemblies help prevent hose-to-hose abrasion at high stress levels. Bonding 2 to 10 varying-sized hoses (maximum 6” (152 mm) wide) together, bonded assemblies keep hoses from rubbing against each other or tangling.



Smaller I.D.

- The Parflex manufacturing process does not require a mandrel for support of the core tube so hoses can be made to a smaller inner diameter such as 1.3 mm (.051 inch).

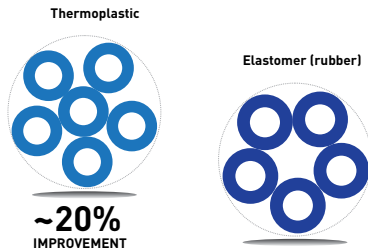

Compact O.D.

- Compact designs allow for a tighter bend radius, allowing the hose to be used in smaller work envelopes and facilitate quicker installs (up to 50%).

| Size | Typical 100R17 Hose (rubber) | | D6R Hose | | Space Benefit |
|------|------------------------------|------|----------|------|---------------|
| | inch | mm | inch | mm | |
| -4 | 0.52 | 13.2 | 0.46 | 11.7 | 11% |
| -6 | 0.67 | 17.0 | 0.61 | 15.5 | 9% |
| -8 | 0.81 | 20.6 | 0.76 | 19.3 | 7% |
| -10 | 0.98 | 24.8 | 0.96 | 24.4 | 2% |
| -12 | 1.15 | 29.2 | 1.15 | 29.2 | 0% |
| -16 | 1.47 | 37.3 | 1.44 | 36.5 | 2% |

Abrasion Resistance

- In our new Polymer Innovation Center, Parflex engineers blend resins and create patented designed hoses to reduce permeation and withstand hours of abrasion without damaging the hose.

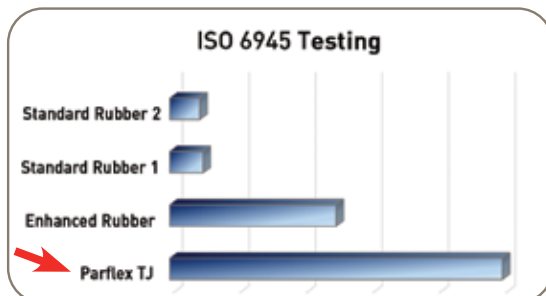

Lightweight

- Parflex products are lighter in weight due to their fiber reinforcements. In fact, a Parflex hose can weigh more than 70% less than a comparable rubber hose assembly.

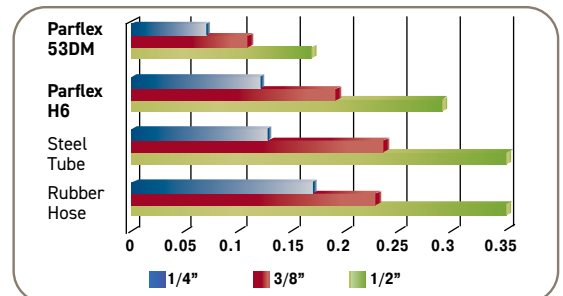

Fluoropolymer Hose Advantages

Parker Parflex manufactures PTFE hose for most markets that require high temperatures, chemical resistant hoses, or have applications where lubricity plays a critical factor in the success of the operation. Increased lubricity facilitates flow and makes for easy cleaning.

Chemical Compatibility

- The chemical compatibility of fluoropolymers is far greater than conventional thermoplastics or rubber products.

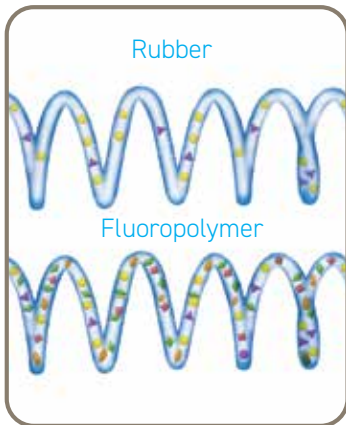

High/Low Temperatures

- PTFE products boast an operating temperature range of -100°F (73°C) to 500°F (260°C). For FEP and PFA, view specific materials for actual operating temperatures.

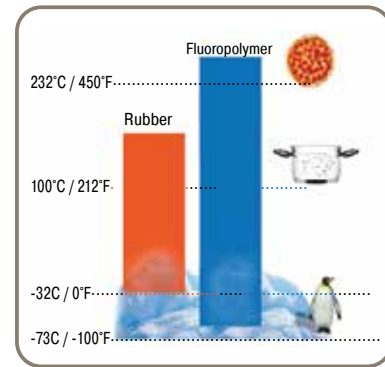

- In cold or heat, Fluoropolymers provide improved performance to flexing, vibration and impulse. Customers who make the switch not only reduce unscheduled maintenance repairs, but often, warranty repairs as well.

Shelf Life

- Under optimal storage conditions, fluoropolymer and thermoplastic hose and tubing products should have unlimited storage life prior to initial usage.*

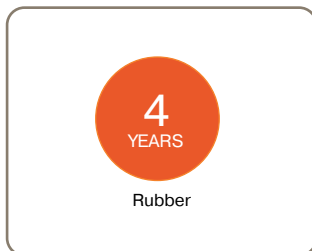

Eliminate Drive Time With The Best Portable Crimper On the Market



Grab & Go

Create factory style assemblies in minutes.

Ready to go at a moments notice.

With no additional power source required for operation and a built in carry handle, the MiniKrimp® is easy to transport to remote locations.

- Weight: 45 lbs. or less
- Force: 30,000 tons @ 10,000 psi max
- Cycle time: Approximately 30 seconds

Speed Up Installations with Rapid Assembly Wrenchless Fittings

No Tools Necessary

Speed Up Hose Installation by 50%



[Watch the Video](#)

56 Rapid Assembly Series

With one adapter, speed up assembly installations by 50%. Simply screw in the adapter and push the tube stub fitting into the adapter.

- Available for hoses qualified with 56-series fittings and pressures up to 3000 psi
- Typical Applications
 - Pilot lines
 - Joystick
 - Skid steer chassis

Reduce costs without reducing performance.

51R Series

The 51R-series is the newest generation of Parflex field attachable fittings. With assembly possible via a deep well socket or screw gun and a vise, field repair and/or assembly has never been quicker.



[Watch the Video](#)

- Available for 510D and 518D hoses (-3, -4, -6 and -8)
- Typical Applications
 - Hydraulic lines
 - Aerial lift
 - Car carrier

Hose
A

Tubing
Thermoplastic
B

Coiled Air Hose
& Fittings
C

Transportation
D

Fittings
E

Tooling, Equipment
& Accessories
F

General Technical
G

Parflex Manufactures Tubing for Almost Every Application

Not only is the tubing selection complete, so are the options to improve installation times. Parflex offers cut pieces, assemblies, bundled tubing, formed tubing, and combinations of all options.



Parflex Tubing

- Air Brake
- Flame Resistant
- Diesel Fuel
- Nylon
- Polypropylene
- Polyurethane
- Polyethylene
- PVC
- Retractable Coils
- PTFE
- FEP
- PFA/High Purity PFA
- Beading
- Electrical Insulation
- Convoluted
- Corrugated
- Spiral Wrap
- Heat Shrink



Tubing Highlights



Hose
A

Airbrake Tubing

- Every year, Parflex makes enough airbrake tubing to circle the globe
- Available in made to length harnesses for quicker installations
- Excellent UV stability
- Meets SAE Specification J844
- Most sizes meet DOT FMVSS 49CFR 571.106

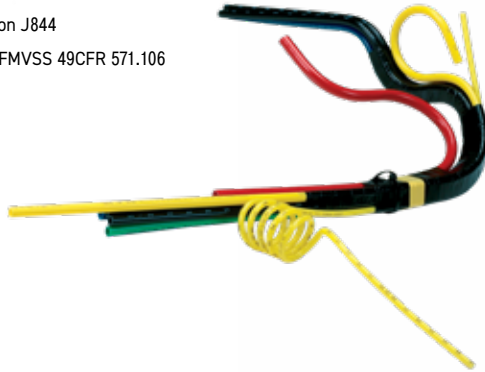

Tubing
Thermoplastic
B

Heat Shrinkable Tubing

- PTFE Shrink - 2:1, 4:1
- FEP Shrink - 1.3/1, 1.67/1
- FEP Roll Cover - 1.25/1
- FDA compliant
- USP Class VI compliant



Coiled Air Hose
& Fittings
C

Flame Resistant Tubing

- Extremely flexible tubing with a flame resistant jacket to protect the core tube from weld spatter and harsh environment applications. The specially formulated jacket material is easy to skive, exposing the core tube for quick insertion into Parker's Prestolok PLM fittings
- Use with Parflex Skive Tool for easy skiving
- UL-94 V0 compliant jacket



Transportation
D

Fittings
E

Tooling, Equipment
& Accessories
F

General Technical
G

Notes

| | |
|---|--|
| A Hose | |
| B Tubing Thermoplastic | |
| C Coiled Air Hose & Fittings | |
| D Transportation | |
| M Fittings | |
| T Tooling, Equipment, & Accessories | |
| G General Technical | |



Parflex



Hose

Thermoplastic

Fluoropolymer

Table of Contents



Parflex

HOSE

| | |
|---|-----|
| Hose Index | A-4 |
| Thermoplastic - Fiber Reinforced | A-4 |
| Thermoplastic - Wire Reinforced & Non-Conductive..... | A-5 |
| Fluoropolymer - PTFE..... | A-6 |

TECHNICAL DATA

| | |
|--|------|
| Agency Specifications | A-7 |
| PTFE Hose Chemical Resistance | A-8 |
| Hose Construction | A-9 |
| Construction/Specs, Thermoplastic Hose psi | A-10 |
| Construction/Specs, Thermoplastic Hose MPa | A-14 |
| Construction/Specs, PTFE Hose psi | A-12 |
| Construction/Specs, PTFE Hose MPa | A-16 |
| Selection of Hose Diameter | A-18 |
| Calculation of Hose Length | A-19 |
| Selecting the Correct Hose "Stamped" | A-19 |
| Hose Material Features | A-20 |
| Hose Material Overview | A-21 |
| Compatibility Guide Media/Hose Material..... | A-22 |
| Volumetric Expansion of Hose..... | A-26 |
| Selection, Installation Maintenance..... | A-27 |

NOMENCLATURE

| | |
|--|------|
| Nomenclature, Thermoplastic Hose | A-29 |
| Nomenclature, Parflex PTFE Hose | A-30 |
| Nomenclature, "PAGE" PTFE Hose | A-31 |

Designing "problem-solving hoses"
is what we do best
and that's why
it's hard to match
the cost saving value
of a Parflex hose.



Hose Index

Thermoplastic - Fiber Reinforced



Fiber Reinforced Thermoplastic Hose

| Part No. | Description | Pg. |
|--|--|------|
|  510C | General Hydraulic <small>Obsolete see 510D/518D</small> | A-43 |
|  510D | General Hydraulic | A-44 |
|  520N | General Hydraulic | A-47 |
|  527BA | Breathing Air Refill 7,000 psi | A-48 |
|  53DM | 53DM - Low Temp  | A-51 |
|  540N | General Hydraulic <small>Obsolete see 510D/518D</small> | A-49 |
|  540P | Specialty Water | A-50 |
|  55LT | Low Temperature  | A-52 |
|  56DH | Diagnostic | A-53 |
|  575X/ 575XN | Fast Response 5,000 psi | A-54 |
|  580N | High Pressure | A-55 |

Fiber Reinforced Thermoplastic Hose

| Part No. | Description | Pg. |
|---|-----------------------------------|------|
|  1035HT | High Temperature Power Cleaning | A-57 |
|  B9 | General Purpose | A-58 |
|  HLB/ HLBD | Lubrication | A-62 |
|  MSH | Marine Steering | A-63 |
|  MSXL | Marine Steering, High Pressure | A-64 |
|  PTH | Marine Power Tilt | A-65 |
|  S5N | Predator® Water Jetting 4,000 psi | A-66 |
|  S6 | Predator® Water Jetting 2,500 psi | A-67 |
|  S9 | Predator® Water Jetting 3,000 psi | A-68 |

Fiber Reinforced Conductive Natural Gas Thermoplastic Hose

| Part No. | Description | Pg. |
|---|---|------|
|  5CNG | Compressed Natural Gas Electrically Conductive | A-59 |
|  8LPG | LPG / Compressed Natural Gas, Electrically Conductive | A-61 |

Tubing Thermoplastic

Coiled Air Hose & Fittings

Transportation

Fittings

Tooling, Equipment, & Accessories

General Technical

Hose Index

Thermoplastic - Wire Reinforced & Non Conductive

Wire Reinforced Thermoplastic Hose

| Part No. | Description | Pg. |
|---|---|--|
|  563LT | Low Temperature Hydraulic 3000 psi Constant Pressure |  A-40 |
|  560TJ | TOUGHJACKET™ General Hydraulic |  A-38 |
|  563TJ | TOUGHJACKET™ 3000 psi Constant Pressure |  A-39 |
|  590TJ | TOUGHJACKET™ General Hydraulic |  A-41 |
|  594TJ | TOUGHJACKET™ 4000 psi Constant Pressure |  A-42 |
|  2245N | High Pressure Hose | A-82 |

Wire Reinforced Thermoplastic Hose

| Part No. | Description | Pg. |
|--|--|--|
|  D6R | 3000 psi Constant Pressure | A-32 |
|  H6 | Hydraulic Hose, Constant Pressure 3,000 psi <small>Obsolete see 53DM/563LT</small> |  A-35 |
|  HFSR | Hybrid® Hose with Rubber Cover <small>Obsolete see 560TJ/563TJ</small> | A-33 |
|  HFS2R | Hybrid® Hose with Rubber Cover, 2 braids | A-34 |
|  HTBR | Eliminator® Compact | A-37 |
|  R6 | 3000 psi Constant Pressure <small>Obsolete see 563TJ/563LT</small> |  A-36 |

Wire Reinforced Conductive Natural Gas Thermoplastic Hose

| Part No. | Description | Pg. |
|---|---|------|
|  CNGRP | Regulated Pressure CNG Electrically Conductive | A-60 |

Non-Conductive Thermoplastic Hose

| Part No. | Description | Pg. |
|--|--|--|
|  518C | Hydraulic Non Conductive <small>Obsolete see 510D/518D</small> | A-45 |
|  518D | Hydraulic Non Conductive | A-46 |
|  528N | General Hydraulic Non-Conductive | A-47 |
|  538DM | DuraMax Low Temp Non-Conductive |  A-51 |
|  578X | Fast Response Non-Conductive | A-54 |
|  588N | High Pressure Non-Conductive | A-55 |
|  83FR | General Purpose Non-Conductive | A-56 |



Hose Index

Fluoropolymer

900 Series Fluoroplastic Hose

| Part No. | Description | Pg. |
|---|--|------|
|  919 919B | PTFE Natural Core/ Static Dissipative Core | A-69 |
|  919J 919BJ | Silicone Jacketed PTFE Static Dissipative Core | A-70 |
|  919U | Silicone Jacketed PTFE Natural Core | A-71 |
|  929 929B | Heavy Wall PTFE Natural / Static Dissipative Core | A-72 |
|  929BJ | Silicone Covered Heavy Wall PTFE Static Dissipative Core | A-73 |
|  939 939B | Convuluted PTFE Natural/ Static Dissipative Core | A-74 |
|  944B | High Pressure PTFE Static Dissipative, up to 4,500 psi | A-75 |
|  955B | High Pressure PTFE Static Dissipative Core, 5,000 psi | A-76 |

Other Hoses

| Part No. | Description | Pg. |
|---|----------------|------|
|  METAL | Metal Hose | A-83 |
|  MLT | Multitube Hose | A-84 |

PAGE Fluoroplastic Hose

| Part No. | Description | Pg. |
|---|--|------|
|  STW STB | PTFE Natural / Static Dissipative Core | A-77 |
|  SCW SCB | Convuluted PTFE Natural/ Static Dissipative Core | A-78 |
|  SCWV SCBV | Heavy Wall Convuluted PTFE Natural /Static Dissipative Core | A-79 |
|  PCW PCB | Polypropylene Braid Convuluted PTFE Natural /Static Dissipative Core <small>Obsolete</small> | A-80 |
|  NCW NCB | Nomex Braid Convuluted PTFE Natural /Static Dissipative Core | A-81 |

Static Dissipative Fluoroplastic Hose

| Part No. | Description | Pg. |
|--|--|--------------|
|  919B STB | PTFE Static Dissipative | A-69 A-77 |
|  919BJ | Silicone Jacketed PTFE Static Dissipative | A-70 |
|  929B | Heavy Wall PTFE Static Dissipative | A-72 |
|  929BJ | Silicone Covered Heavy Wall PTFE Static Dissipative | A-73 |
|  939B SCB | Convuluted PTFE Static Dissipative | A-74 A-78 |
|  944B | High Pressure PTFE Static Dissipative, up to 4,500 psi | A-75 |
|  955B | 5000 psi High Pressure PTFE Static Dissipative | A-76 |
|  NCB | Nomex Braid Convuluted PTFE Static Dissipative | A-81 |
|  PCB | Polypropylene Braid Convuluted PTFE Static Dissipative <small>Obsolete</small> | A-80 |
|  SCBV | Heavy Wall Convuluted PTFE Static Dissipative | A-79 |

Agency Specifications

| Agency Specifications | Hose Series |
|--|---|
| Flame Resistance | |
| MSHA | D6R, HFS2R, HLB, HLBD, HTBR, 510D, 560TJ, 563TJ, 590TJ, 594TJ, 520N, 540N, 56DH-2, 575X, 580N, 83FR |
| UL94HB | 83FR |
| Food Contact | |
| FDA, CFR21 Part 177 | 540P, 919, 919J, 919U, 929, 939, STW, SCW, SCWW |
| Natural Gas Service: For Vehicles and Dispensing Systems | |
| ANSI CSA NGV 4.2; NFPA 52; CSA 12.52 Class A, Class D, Class B** | 5CNG; **5CNG-8 |
| ANSI CSA NGV 3.1; NFPA 52; CSA 12.3, Class C | CNGRP |
| ECE-R110 | 5CNG factory built assemblies, 8LPG |
| ECE-R67 | 8LPG |
| Hydraulic Service: | |
| ISO 3949 | 510D, 518D, HLBD |
| SAE 100R1AT | 560TJ |
| SAE 100R7 | 540N, 540P, 510D, 518C, 518D, 55LT, 510C (less-2) |
| SAE 100R8 | 520N, 528N, 580N, 588N |
| SAE 100R14A | 919, 919J, 919U, 929 |
| SAE 100R14B | 919B, 919BJ, 929B, 929BJ |
| SAE 100R17 | D6R, 563TJ, 563LT |
| SAE 100R18 | 53DM, 538DM |
| SAE 100R19 | 594TJ |
| Electrical, Non-Conductivity: | |
| SAE J517 | 518C, 518D, 528N, 578X, 588N, 538DM |
| DNV (with approved fittings only) | |
| Det Norski (Norwegian) Veritas Marine Steel Ships, Mobile Offshore & Fixed Offshore Drilling Units | 510C, 510D, 518C, 518D, 520N, 528N, 540N, 575X, 575XN, 580N, 588N |
| Breathing Air Applications: | |
| CGA (Compressed Gas Association)- G7.1-1 Grade E Breathing Air | 527BA |
| NFPA 1901 | 527BA |
| United States Pharmacopeia | |
| USP Class VI | SCW, STW, SCWW, NCW |

Hose
A

Tubing
Thermoplastic
B

Coiled Air Hose
& Fittings
C

Transportation
D

Fittings
E

Tooling, Equipment
& Accessories
F

General Technical
G

PTFE Hose Chemical Resistance

Summary

Within normal use, temperatures, fluoropolymers are attacked by so few chemicals that it is easier to describe the exceptions rather than list the chemicals they are compatible with.

DO NOT USE FLUOROPLASTICS WITH THE FOLLOWING:

- Alkali metals such as elemental sodium, potassium, lithium, etc. The alkali metals remove fluorine from the polymer molecule.
- Extremely potent oxidizers, fluorine (F₂) and related compounds (e.g., chlorine trifluoride, ClF₃). These can be handled by fluoropolymers, but only with great care, as fluorine is absorbed into the resins, and the mixture becomes sensitive to a source of ignition such as impact.

WARNING

FAILURE OR IMPROPER SELECTION OR IMPROPER USE OF THE PRODUCTS AND/OR SYSTEMS DESCRIBED HEREIN OR RELATED ITEMS CAN CAUSE DEATH, PERSONAL INJURY AND PROPERTY DAMAGE.

This document and other information from Parker Hannifin Corporation, its subsidiaries and authorized distributors provide product and/or system options for further investigation by users having technical expertise. It is important that you analyze all aspects of your application and review the information concerning the product or system in the current product catalog. Due to the variety of operating conditions and applications for these products or systems, the user, through its own analysis and testing, is solely responsible for making the final selection of the products and systems and assuring that all performance, safety and warning requirements of the application are met.

The products described herein, including without limitation, product features, specifications, designs, availability and pricing, are subject to change by Parker Hannifin Corporation and its subsidiaries at any time without notice.

Hose Construction

Hose Core, Reinforcement, Cover

Thermoplastic Hose Construction

Core

Contains Media
Materials: Nylon, Polyethylene, Polyurethane, Copolyester

Reinforcement

Provides Resistance to Internal Pressure
Materials: Fiber (Nylon, Polyester, Aramid), Steel, Stainless Steel

Cover

Protects Reinforcement
Advantages: Aesthetics, Color and Marking
Materials: Polyurethane, Nylon, Synthetic Rubber, Copolyester, and TPV



TOUGHJACKET™ Covers

Manufactured from Parflex
TOUGHJACKET™ Polyurethane and designed to withstand the strains of demanding use.

Look for the TJ - Currently found on 560TJ, 563TJ, 590TJ and 594TJ



Fluoropolymer Hose Construction

Core

Contains Media
Materials: PTFE
Style: Smoothbore or Convoluted

Reinforcement

Provides Resistance to Internal Pressure
Materials: Stainless Steel, Polypropylene and Nomex®

Cover or Protective Sleeve

Protects Reinforcement
Materials: Silicone, Polyolefin, Polyurethane

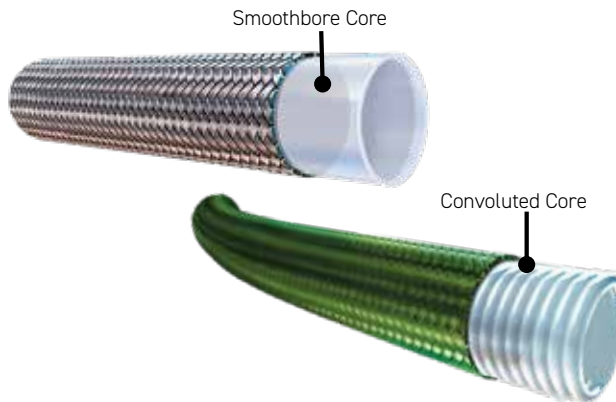

Construction/Specifications

Thermoplastic Hose, psi

A Hose

B Tubing Thermoplastic

C Coiled Air Hose & Fittings

D Transportation

E Fittings

F Tooling, Equipment, & Accessories

G General Technical

| Reinforcement Type | PSI Thermoplastic Hose Working Pressures | | | | | | | | | | | |
|--------------------|--|---|--|--------|--------|--------|--------|--------|--------|--------|--------|--------|
| | | 3/32 | 1/8 | 3/16 | 1/4 | 5/16 | 3/8 | 1/2 | 5/8 | 3/4 | 1 | |
| | Dash Size | -1.5 | -2 | -3 | -4 | -5 | -6 | -8 | -10 | -12 | -16 | |
| Hose | Description | psi | psi | psi | psi | psi | psi | psi | psi | psi | psi | |
| Wire | CNGRP* | Regulated Pressure CNG | | | | | | | 500 | 500 | | |
| | D6R | Hybrid® SAE 100R17 Hydraulic Hose | | | | 3045 | 3045 | 3045 | 3045 | | | |
| | H6 | Low Temperature SAE 100R17 <small>Obsolete see 53DM/563LT</small> | | | | 3045 | 3045 | 3045 | 3045 | 3045 | | |
| | HFSR | SAE 100R1AT Hydraulic Hose <small>Obsolete see 560TJ/563TJ</small> | | | | 3263 | 3118 | 2611 | 2500 | | 1276 | |
| | HFS2R | Hybrid® Hydraulic Hose | | | | 5076 | | 4061 | 3553 | | | |
| | R6 | Abrasion King, SAE 100R17 <small>Obsolete see 563TJ/563LT</small> | | | | 3000 | | 3000 | 3000 | 3000 | | |
| | HTBR | Eliminator® Hybrid® Hydraulic Hose | | | | | | 5500 | 5000 | 4000 | 4000 | |
| | 560TJ | SAE 100R1AT TOUGHJACKET™ | | | 3626 | 3263 | 3118 | 2750 | 2500 | 2000 | 1750 | |
| | 563TJ | SAE 100R17 TOUGHJACKET™ | | | | 3045 | | 3045 | 3045 | 3045 | 3045 | |
| | 563LT | Constant Pressure Low Temperature | | | | | | 3045 | 3045 | 3045 | | |
| | 590TJ | General Hydraulic TOUGHJACKET™ | | | | 5076 | | 4061 | 3553 | | 2500 | |
| | 594TJ | SAE 100R19 TOUGHJACKET™ | | | | 4061 | | 4061 | 4061 | 4061 | 4061 | |
| | Fiber | 510C | SAE 100R7 Hydraulic Hose <small>Obsolete see 510D/518D</small> | | 2500 | 3250 | 3000 | 2500 | 2250 | 2250 | | 1250 |
| | | 510D | SAE 100R7 Hydraulic Hose | | | 3250 | 3000 | 2500 | 2250 | 2250 | 2250 | 1250 |
| | | 518C | SAE 100R7 Non-conductive Hose <small>Obsolete see 510D/518D</small> | | 2500** | 3250** | 3000** | 2500** | 2250** | 2250** | | 1250** |
| 518D | | SAE 100R7 Non-conductive Hose | | 3000** | 3250** | 3000** | 2500** | 2250** | 2250** | 2250** | 1250** | |
| 520N / 528N | | SAE 100R8 Hydraulic Hose | | | 5000 | 5000 | 4500 | 4000 | 3500 | | | |
| 527BA | | Breathing Air Refill Hose | | | 7000 | 7000 | | | | | | |
| 53DM | | SAE 100R18 Low Temperature Hydraulic Hose | | 3045 | | 3045 | | 3045 | 3045 | 3045 | 3045 | |
| 538DM | | SAE 100R18 Low Temperature Hydraulic Hose Non-Conductive | | | | | | 3045 | | | | |
| 540N | | SAE 100R7 - Hydraulic Hose <small>Obsolete see 510D/518D</small> | | 3000 | 3000 | 2750 | 2500 | 2250 | 2000 | | 1250 | |
| 540P | | SAE 100R7 Specialty Water Hose | | | | 2750 | | 2250 | 2000 | | | |
| 55LT | | SAE 100R7 Low Temperature Hydraulic Hose | | | 3250 | 3000 | 2500 | 2250 | 2000 | | | |
| 56DH | | Diagnostic Hose | 6000 | 6000 | | | | | | | | |
| 575X / 575XN | | Fast Response Hydraulic Hose | | | 5000 | 5000 | | 5000 | 5000 | | 5000 | |
| 578X | | Fast Response Hydraulic Hose | | | | 5000 | | 5000 | | | 5000 | |
| 580N / 588N | | SAE 100R8 High Pressure Hydraulic 588N - Non-conductive | | | | | | | 3500 | 2750 | 2250 | |
| 1035HT | High Temperature Power Cleaning | | | | 1750 | | | | | | | |
| 83FR | DuraGard™ General Purpose Polyurethane | | | | 300 | | 300 | 300 | | 300 | | |
| B9 | General Purpose Transfer Hose | | | 250 | 250 | 250 | 250 | 250 | 250 | | | |
| 5CNG | Compressed Natural Gas Hose | | | | 5000 | | 5000 | 5000 | | 5000 | | |
| 8LPG | Propane & Natural Gas Hose | | | 435 | 435 | 435 | 435 | | | | | |
| HLB/HLBD | SAE 100R7 Hydraulic & Lubrication Hose | | 3000 | 3000 | | | | | | | | |
| MSH | Marine Steering Hose | | | | | 1000 | 1000 | | | | | |
| MSXL | Fast Response Marine Steering Hose | | | | | 1500 | | | | | | |
| PTH | Marine Power Tilt Hose | | | 3000 | | | | | | | | |
| S5N | Sewer Cleaning - Lateral Cleaning | | | | | | | 4000 | | | | |
| S6 | Sewer Cleaning | | | | | | | | | 2500 | | |
| S9 | Sewer Cleaning | | | | | | | | | 3000 | | |

* Sizing for -10 is 1/2"; for -12 is 5/8"
 **View actual hose chart for ANSI pressure ratings

Legend

- F - Fiber
- N - Nylon
- R - Smooth Synthetic Rubber
- H - Copolyester
- O - Polyethylene
- S - Silicone
- U - Polyurethane
- UTJ - TOUGHJACKET™ Polyurethane
- X - TPV

Construction/Specifications

Thermoplastic Hose, psi

Hose
A

| PSI Thermoplastic Hose Working Pressure | | | | | | | | Reinforcement Type |
|---|------------------------|----------------|-------------------|--|--------|--|--------------|--------------------|
| Core Tube | Reinforcement Material | Cover Material | SAE Specification | Additional Specifications | Page # | Description | Hose | |
| N | Wire | X | - | ANSI CSA NGV 3.1; NFPA 52; CSA 12.3, Class C | A-60 | Regulated Pressure CNG | CNGRP* | Wire |
| H | Wire | R | 100R17 | MSHA/ ISO 11237 Type R17 | A-32 | Hybrid® SAE 100R17 Hydraulic Hose | D6R | |
| H | Wire | H | 100R17 | | A-35 | Low Temperature SAE 100R17 | H6 | |
| H | Wire | R | 100R1AT | | A-33 | SAE 100R1AT Hydraulic Hose | HFSR | |
| H | Wire | R | - | MSHA | A-34 | Hybrid® Hydraulic Hose | HFS2R | |
| H | Wire | F | 100R17 | | A-36 | Abrasion King, SAE 100R17 | R6 | |
| H | Wire | R | | MSHA | A-37 | Eliminator® Hybrid® Hydraulic Hose | HTBR | |
| H | Wire | UTJ | 100R1AT | MSHA | A-38 | SAE 100R1AT TOUGHJACKET™ | 560TJ | |
| H | Wire | H | 100R17 | MSHA | A-39 | SAE 100R17 TOUGHJACKET™ | 563TJ | |
| H | Wire | UTJ | 100R17 | | A-40 | Constant Pressure Low Temperature | 563LT | |
| H | Wire | UTJ | | MSHA | A-41 | General Hydraulic TOUGHJACKET™ | 590TJ | |
| H | Wire | UTJ | 100R19 | MSHA | A-42 | SAE 100R19 TOUGHJACKET™ | 594TJ | |
| H | Fiber | U | 100R7*** | MSHA***, DNV | A-43 | SAE 100R7 Hydraulic Hose | 510C | Fiber |
| N | Fiber | U | 100R7 | MSHA, DNV, ISO 3949 | A-44 | SAE 100R7 Hydraulic Hose | 510D | |
| H | Fiber | U | 100R7 | ANSI A92.2, DNV | A-45 | SAE 100R7 Non-conductive Hose | 518C | |
| N (H-16) | Fiber | U | 100R7 | ANSI A92.2, DNV, ISO 3949 | A-46 | SAE 100R7 Non-conductive Hose | 518D | |
| N | Fiber | U | 100R8 | MSHA***, DNV | A-47 | SAE 100R8 Hydraulic Hose | 520N / 528Na | |
| N | Fiber | U | - | CGA / NFPA 1901 | A-48 | Breathing Air Refill Hose | 527BA | |
| N-2 (H-16) | Fiber | H | 100R18 | | A-51 | SAE 100R18 Low Temperature Hydraulic Hose | 53DM | |
| H | Fiber | H | 100R18 | | A-51 | SAE 100R18 Low Temperature Hydraulic Hose Non-Conductive | 538DM | |
| N | Fiber | U | 100R7 | MSHA | A-49 | SAE 100R7 - Hydraulic Hose | 540N | |
| O | Fiber | U | 100R7 | FDA | A-50 | SAE 100R7 Specialty Water Hose | 540P | |
| H | Fiber | H | 100R7 | | A-52 | SAE 100R7 Low Temperature Hydraulic Hose | 55LT | |
| N | Fiber | U | - | MSHA*** | A-53 | Diagnostic Hose | 56DH | |
| N | Fiber | U | - | MSHA***, DNV | A-54 | Fast Response Hydraulic Hose | 575X/575XN | |
| U | Fiber | N | - | SAE J517 | A-54 | Fast Response Hydraulic Hose | 578X | |
| N | Fiber | U | 100R8 | MSHA, DNV | A-55 | SAE 100R8 High Pressure Hydraulic 588N - Non-conductive | 580N/588N | |
| N | Fiber | U | - | | A-57 | High Temperature Power Cleaning | 1035HT | |
| U | Fiber | U | UL94HB | MSHA | A-56 | DuraGard™ General Purpose Polyurethane | 83FR | |
| U | Fiber | U | - | | A-58 | General Purpose Transfer Hose | B9 | |
| N | Fiber | U | - | ANSI CSA NGV 4.2; ECE R110***; NFPA 52; CSA 12.52 Class A, Class D, Class B*** | A-59 | Compressed Natural Gas Hose | 5CNG | |
| N | Fiber | N | - | ECE R67 Class 1, ECE R110 CNG Class 6, CSA Certified | A-61 | Propane & Natural Gas Hose | 8LPG | |
| N and H | Fiber | U | 100R7 (HLBD) | MSHA, ISO 3949 (HLBD) | A-62 | SAE 100R7 Hydraulic & Lubrication Hose | HLB/HLBD | |
| N | Fiber | U | - | | A-63 | Marine Steering Hose | MSH | |
| N | Fiber | U | - | | A-64 | Fast Response Marine Steering Hose | MSXL | |
| N | Fiber / SS Wire | U | - | | A-65 | Marine Power Tilt Hose | PTH | |
| N | Fiber | U | - | | A-66 | Sewer Cleaning - Lateral Cleaning | S5N | |
| H | Fiber | U | - | | A-67 | Sewer Cleaning | S6 | |
| H | Fiber | U | - | | A-68 | Sewer Cleaning | S9 | |

***View Government & Agency Specifications for exceptions, pg. A-7

| | | | |
|---------------|-----------------------------|------------------|---------------------------------|
| Legend | F - Fiber | H - Copolyester | U - Polyurethane |
| | N - Nylon | O - Polyethylene | UTJ - TOUGHJACKET™ Polyurethane |
| | R - Smooth Synthetic Rubber | S - Silicone | X - TPV |

Tubing
Thermoplastic
B

Coiled Air Hose
& Fittings
C

Transportation
D

Fittings
E

Tooling, Equipment
& Accessories
F

General Technical
G

Construction/Specifications

Fluoropolymer Hose, psi

A Hose

B Tubing Thermoplastic

C Coiled Air Hose & Fittings

D Transportation

E Fittings

F Tooling, Equipment, & Accessories

G General Technical

| Reinforcement Type | | PSI Fluoropolymer Hose Working Pressures | | | | | | | | | | | | | | | |
|--------------------|---------------|--|-----|---------------|---------------|------|------|---------------|------|------|--------------|-------|------|------|------|------|-----|
| | | Fractional Size | | Nominal Sizes | | | | | | | | | | | | | |
| | | | | 1/8 | 3/16 15/64 | 1/4 | 5/16 | 13/32 7/16 | 1/2 | 5/8 | 7/8 29/32 | 1-1/8 | 1/8 | 1/4 | 3/8 | 1/2 | 5/8 |
| | | Dash Size | | -3 | -4 | -5 | -6 | -8 | -10 | -12 | -16 | -20 | -3 | -4 | -6 | -8 | -10 |
| Hose | Description | psi | psi | psi | psi | psi | psi | psi | psi | psi | psi | psi | psi | psi | psi | | |
| Wire | 919 | PTFE Hose | | 3000 | 3000 | 2500 | 2000 | 1500 | 1200 | 1000 | 625 | | | | | | |
| | 919B | PTFE Hose with static-dissipative core | | 3000 | 3000 | 2500 | 2000 | | | | | | | | | | |
| | 919J | Silicone Covered PTFE Hose | | 3000 | 3000 | 2500 | 2000 | 1500 | 1200 | 1000 | | | | | | | |
| | 919BJ | Silicone Covered PTFE Hose with static-dissipative core | | 3000 | 3000 | 2500 | 2000 | 1500 | 1200 | 1000 | | | | | | | |
| | 919U | High Abrasion Resistance PTFE Hose | | 3000 | | 2500 | 2000 | | 1200 | 1000 | | | | | | | |
| | 929 | Heavy Wall PTFE Hose | | 3000 | | 2500 | 2000 | | | | | | | | | | |
| | 929B | Heavy Wall PTFE Hose with static-dissipative core | | 3000 | | 2500 | 2000 | | 1200 | 1250 | | | | | | | |
| | 929BJ | Silicone Covered PTFE Hose with static-dissipative core | | 3000 | | 2500 | 2000 | | 1200 | 1250 | | | | | | | |
| | 939 | Convuluted PTFE Hose | | | | | | | | | | | | 1500 | 1350 | 1000 | |
| | 939B | Convuluted PTFE Hose with static-dissipative core | | | | | | | | | | | | 1500 | 1350 | 1000 | |
| Other | 944B | High Pressure PTFE Hose with static-dissipative core | | | | 4500 | 4500 | 4000 | 4000 | 4000 | | | | | | | |
| | 955B | High Pressure PTFE Hose with static-dissipative core | | 5500 | | 5500 | 5500 | 5500 | 5500 | 5500 | | | | | | | |
| | STW Z-STW* | PAGE Heavy Wall PTFE Hose *Double Braid | | | | | | | | | | | 3000 | 2000 | 1750 | | |
| | STB Z-STB* | PAGE Heavy Wall PTFE Hose with static-dissipative core *Double Braid | | | | | | | | | | | 3000 | 2000 | 1750 | | |
| | SCW | PAGE Convuluted PTFE Hose | | | | | | | | | | | 1500 | 1500 | 1500 | | |
| | SCB | PAGE Convuluted PTFE Hose with static-dissipative core | | | | | | | | | | | 1500 | 1500 | 1500 | | |
| | SCWV | PAGE Heavy Wall Convuluted PTFE Hose | | | | | | | | | | | | | 1500 | | |
| | SCBV | PAGE Heavy Wall Convuluted PTFE Hose with static-dissipative core | | | | | | | | | | | | | 1500 | | |
| | NCW | PAGE Nomex Braid Convuluted | | | | | | | | | | | | 725 | 400 | 280 | |
| | NCB | PAGE Nomex Braid Convuluted with static-dissipative core | | | | | | | | | | | | 725 | 400 | 280 | |

*Z indicates double braid for sizes over 1".

Legend

PTFE - Polytetrafluoroethylene

PTFE-S - Polytetrafluoroethylene, Static Dissipative

U - Polyurethane

NB - Nomex Braid

PP - Polypropylene

S - Silicone

Construction/Specifications

Fluoropolymer Hose, psi

| PSI Fluoropolymer Construction and Specifications | | | | | | | | | | | | | | Reinforcement Type |
|---|--------------|-------|-------|-----|-------|-----|-----|-----------|------------------------|----------------|--------|--|---------------|--------------------|
| 3/4 | 1 | 1 1/4 | 1 1/2 | 2 | 2-1/2 | 3 | 4 | | | | | Fractional Size | | |
| -12 | -16 | -20 | -24 | -32 | -40 | -48 | -64 | Core Tube | Reinforcement Material | Cover Material | Page # | Description | Hose | |
| psi | psi | psi | psi | psi | psi | psi | psi | | | | | | | |
| | | | | | | | | PTFE | SS Wire | — | A-69 | PTFE Hose | 919 | Wire |
| | | | | | | | | PTFE-S | SS Wire | — | A-69 | PTFE Hose with static-dissipative core | 919B | |
| | | | | | | | | PTFE | SS Wire | S | A-70 | Silicone Covered PTFE Hose | 919J | |
| | | | | | | | | PTFE-S | SS Wire | S | A-70 | Silicone Covered PTFE Hose with static-dissipative core | 919BJ | |
| | | | | | | | | PTFE | SS Wire | U | A-71 | High Abrasion Resistance PTFE Hose | 919U | |
| | | | | | | | | PTFE | SS Wire | — | A-72 | Heavy Wall PTFE Hose | 929 | |
| | | | | | | | | PTFE-S | SS Wire | — | A-72 | Heavy Wall PTFE Hose with static-dissipative core | 929B | |
| | | | | | | | | PTFE-S | SS Wire | S | A-73 | Silicone Covered PTFE Hose with static-dissipative core | 929BJ | |
| 1100 | 1000 | 1000 | 750 | 250 | | | | PTFE | SS Wire | — | A-74 | Convoluted PTFE Hose | 939 | |
| 1100 | 1000 | 1000 | 750 | 250 | | | | PTFE-S | SS Wire | — | A-74 | Convoluted PTFE Hose with static-dissipative core | 939B | |
| | | | | | | | | PTFE-S | SS Wire | — | A-75 | High Pressure PTFE Hose with static-dissipative core | 944B | |
| | | | | | | | | PTFE-S | SS Wire | — | A-76 | High Pressure PTFE Hose with static-dissipative core | 955B | |
| 1000 | 1000 1200 | 1000* | 900* | | | | | PTFE | SS Wire | — | A-77 | PAGE Heavy Wall PTFE Hose *Double Braid | STW Z-STW* | |
| 1000 | 1000 1200 | 1000* | 900* | | | | | PTFE-S | SS Wire | — | A-77 | PAGE Heavy Wall PTFE Hose with static-dissipative core *Double Braid | STB Z-STB* | |
| 1200 | 925 | 750 | 650 | 450 | | | | PTFE | SS Wire | — | A-78 | PAGE Convoluted PTFE Hose | SCW | |
| 1200 | 925 | 750 | 650 | 450 | | | | PTFE-S | SS Wire | — | A-78 | PAGE Convoluted PTFE Hose with static-dissipative core | SCB | |
| 1200 | 1000 | 750 | 650 | 450 | 200 | 175 | 150 | PTFE | SS Wire | — | A-79 | PAGE Heavy Wall Convoluted PTFE Hose | SCWV | |
| 1200 | 1000 | 750 | 650 | 450 | 200 | 175 | 150 | PTFE-S | SS Wire | — | A-79 | PAGE Heavy Wall Convoluted PTFE Hose with static-dissipative core | SCBV | |
| 200 | 200 | | | | | | | PTFE | NB | — | A-81 | PAGE Nomex® Braid Convoluted | NCW | Other |
| 200 | 200 | | | | | | | PTFE-S | NB | — | A-81 | PAGE Nomex® Braid Convoluted with static-dissipative core | NCB | |

*Z indicates double braid for sizes over 1".

Legend

PTFE - Polytetrafluoroethylene

PTFE-S - Polytetrafluoroethylene, Static Dissipative

U - Polyurethane

NB - Nomex Braid

PP - Polypropylene

S - Silicone

Construction/Specifications

Thermoplastic Hose, MPa

A Hose

B Tubing Thermoplastic

C Coiled Air Hose & Fittings

D Transportation

E Fittings

F Tooling, Equipment, & Accessories

G General Technical

| Reinforcement Type | PSI Thermoplastic Hose Working Pressures | | | | | | | | | | | | |
|--------------------|---|---|--|--------|--------|--------|--------|--------|--------|--------|-------|-------|-----|
| | | | 3/32 | 1/8 | 3/16 | 1/4 | 5/16 | 3/8 | 1/2 | 5/8 | 3/4 | 1 | |
| | Dash Size | | -1.5 | -2 | -3 | -4 | -5 | -6 | -8 | -10 | -12 | -16 | |
| | Hose | Description | MPa | MPa | MPa | MPa | MPa | MPa | MPa | MPa | MPa | MPa | |
| Wire | CNGRP* | Regulated Pressure CNG | | | | | | | | 3.5 | 3.5 | | |
| | D6R | Hybrid® SAE 100R17 Hydraulic Hose | | | | 21.0 | 21.0 | 21.0 | 21.0 | 21.0 | 21.0 | 21.0 | |
| | H6 | Low Temperature SAE 100R17 <small>Obsolete see 53DM/563LT</small> | | | | 21.0 | 21.0 | 21.0 | 21.0 | | | | |
| | HFSR | SAE 100R1AT Hydraulic Hose <small>Obsolete see 560TJ/563TJ</small> | | | | 22.5 | 21.5 | 18.0 | 17.2 | | 10.5 | 8.8 | |
| | HFS2R | Hybrid® Hydraulic Hose | | | | 35.0 | | 28.0 | 24.5 | | | | |
| | R6 | Abrasion King, SAE 100R17 <small>Obsolete see 563TJ/563LT</small> | | | | 20.7 | | 20.7 | 20.7 | 20.7 | 20.7 | | |
| | HTBR | Eliminator® Hybrid® Hydraulic Hose | | | | | | 37.9 | 34.5 | 27.6 | 27.6 | 24.1 | |
| | 560TJ | SAE 100R1AT TOUGHJACKET™ | | | 25.0 | 22.5 | 21.5 | 19.0 | 17.2 | 13.8 | 12.1 | | |
| | 563TJ | SAE 100R17 TOUGHJACKET™ | | | | 21.0 | | 21.0 | 21.0 | 21.0 | 21.0 | 21.0 | |
| | 563LT | Constant Pressure Low Temperature | | | | | | 21.0 | 21.0 | 21.0 | | | |
| | 590TJ | General Hydraulic TOUGHJACKET™ | | | | 35.0 | | 28.0 | 24.5 | | 17.2 | 14.0 | |
| | 594TJ | SAE 100R19 TOUGHJACKET™ | | | | 28.0 | | 28.0 | 28.0 | 28.0 | 28.0 | | |
| | Fiber | 510C | SAE 100R7 Hydraulic Hose <small>Obsolete see 510D/518D</small> | | 17.2 | 22.4 | 20.7 | 17.2 | 15.5 | 15.5 | | 8.7 | 6.9 |
| | | 510D | SAE 100R7 Hydraulic Hose | | | 22.4 | 21.0 | 17.5 | 15.8 | 15.8 | 15.8 | 8.8 | 7.0 |
| 518C | | SAE 100R7 Non-conductive Hose <small>Obsolete see 510D/518D</small> | | 15.8** | 22.4** | 21.0** | 17.5** | 15.8** | 15.8** | | 8.8** | 7.0** | |
| 518D | | SAE 100R7 Non-conductive Hose | | 21.0** | 22.4** | 21.0** | 17.5** | 15.8** | 15.8** | 15.8** | 8.8** | 7.0** | |
| 520N / 528Na | | SAE 100R8 Hydraulic Hose | | | 34.5 | 34.5 | 31.0 | 27.6 | 24.1 | | | | |
| 527BA | | Breathing Air Refill Hose | | | 48.3 | 48.3 | | | | | | | |
| 53DM | | SAE 100R18 Low Temperature Hydraulic Hose | | 21.0 | | 21.0 | | 21.0 | 21.0 | 21.0 | 21.0 | | |
| 538DM | | SAE 100R18 Low Temperature Hydraulic Hose, Non-conductive | | | | | | 20.7 | | | | | |
| 540N | | SAE 100R7 - Hydraulic Hose <small>Obsolete see 510D/518D</small> | | 20.7 | 20.7 | 19.0 | 17.2 | 15.5 | 13.8 | | 8.6 | | |
| 540P | | SAE 100R7 Specialty Water Hose | | | | 19.0 | | 15.5 | 13.8 | | | | |
| 55LT | | SAE 100R7 Low Temperature Hydraulic Hose | | | 22.4 | 20.7 | 17.2 | 15.5 | 13.8 | | | | |
| 56DH | | Diagnostic Hose | 41.4 | 41.4 | | | | | | | | | |
| 575X / 575XN | | Fast Response Hydraulic Hose | | | 34.5 | 34.5 | | 34.5 | 34.5 | | 34.5 | 34.5 | |
| 578X | | Fast Response Hydraulic Hose | | | | 34.5 | | 34.5 | | | 34.5 | | |
| 580N / 588N | SAE 100R8 High Pressure Hydraulic 588N - Non-conductive | | | | | | | 24.1 | 19.0 | 15.5 | 13.8 | | |
| 1035HT | High Temperature Power Cleaning | | | | 12.1 | | | | | | | | |
| 83FR | DuraGard™ General Purpose Polyurethane | | | | 2.1 | | 2.1 | 2.1 | | 2.1 | | | |
| B9 | General Purpose Transfer Hose | | | 1.7 | 1.7 | 1.7 | 1.7 | 1.7 | 1.7 | | | | |
| 5CNG | Compressed Natural Gas Hose | | | | 34.5 | | 34.5 | 34.5 | | 34.5 | 34.5 | | |
| 8LPG | Propane & Natural Gas Hose | | | 3.0 | 3.0 | 3.0 | 3.0 | | | | | | |
| HLB/HLBD | SAE 100R7 Hydraulic & Lubrication Hose | | 20.7 | 20.7 | | | | | | | | | |
| MSH | Marine Steering Hose | | | | | 6.9 | 6.9 | | | | | | |
| MSXL | Fast Response Marine Steering Hose | | | | | 10.3 | | | | | | | |
| PTH | Marine Power Tilt Hose | | | 20.7 | | | | | | | | | |
| S5N | Sewer Cleaning - Lateral Cleaning | | | | | | | 28.0 | | | | | |
| S6 | Sewer Cleaning | | | | | | | | | 17.2 | 17.2 | | |
| S9 | Sewer Cleaning | | | | | | | | | 20.7 | 20.7 | | |

* Sizing for -10 is 1/2"; for -12 is 5/8"
 **View actual hose chart for ANSI pressure ratings

- Legend**
- F - Fiber
 - H - Copolyester
 - U - Polyurethane
 - N - Nylon
 - O - Polyethylene
 - UTJ - TOUGHJACKET™ Polyurethane
 - R - Smooth Synthetic Rubber
 - S - Silicone
 - X - TPV

Construction/Specifications

Thermoplastic Hose, MPa

Hose
A

| PSI Thermoplastic Construction and Specifications | | | | | | | | | Reinforcement Type |
|---|------------------------|----------------|-------------------|--|--------|---|--------------|----------------------------------|--------------------|
| Core Tube | Reinforcement Material | Cover Material | SAE Specification | Additional Specifications | Page # | Description | Hose | | |
| N | Wire | X | - | ANSI CSA NGV 3.1; NFPA 52; CSA 12.3, Class C | A-60 | Regulated Pressure CNG | CNGRP* | Wire | |
| H | Wire | R | 100R17 | MSHA/ ISO 11237 Type R17 | A-32 | Hybrid® SAE 100R17 Hydraulic Hose | D6R | | |
| H | Wire | H | 100R17 | | A-35 | Low Temperature SAE 100R17 | H6 | | |
| H | Wire | R | 100R1AT | | A-33 | SAE 100R1AT Hydraulic Hose | HFSR | | |
| H | Wire | R | - | MSHA | A-34 | Hybrid® Hydraulic Hose | HFS2R | | |
| H | Wire | F | 100R17 | | A-36 | Abrasion King, SAE 100R17 | R6 | | |
| H | Wire | R | | MSHA | A-37 | Eliminator® Hybrid® Hydraulic Hose | HTBR | | |
| H | Wire | UTJ | 100R1AT | MSHA | A-38 | SAE 100R1AT TOUGHJACKET™ | 560TJ | | |
| H | Wire | UTJ | 100R17 | MSHA | A-39 | SAE 100R17 TOUGHJACKET™ | 563TJ | | |
| H | Wire | H | 100R17 | | A-40 | Constant Pressure Low Temperature | 563LT | | |
| H | Wire | UTJ | | MSHA | A-41 | General Hydraulic TOUGHJACKET™ | 590TJ | | |
| H | Wire | UTJ | 100R19 | MSHA | A-42 | SAE 100R19 TOUGHJACKET™ | 594TJ | | |
| H | Fiber | U | 100R7*** | MSHA***, DNV | A-43 | SAE 100R7 Hydraulic Hose | 510C | Coiled Air Hose & Fittings | |
| N | Fiber | U | 100R7 | MSHA, DNV, ISO 3949 | A-44 | SAE 100R7 Hydraulic Hose | 510D | | |
| H | Fiber | U | 100R7 | ANSI A92.2, DNV | A-45 | SAE 100R7 Non-conductive Hose | 518C | | |
| N (H-16) | Fiber | U | 100R7 | ANSI A92.2, DNV, ISO 3949 | A-46 | SAE 100R7 Non-conductive Hose | 518D | | |
| N | Fiber | U | 100R8 | MSHA***, DNV | A-47 | SAE 100R8 Hydraulic Hose | 520N / 528Na | Transportation | |
| N | Fiber | U | - | CGA / NFPA 1901 | A-48 | Breathing Air Refill Hose | 527BA | | |
| N-2 (H-16) | Fiber | H | 100R18 | | A-51 | SAE 100R18 Low Temperature Hydraulic Hose | 53DM | | |
| H | Fiber | H | 100R18 | | A-51 | SAE 100R18 Low Temperature Hydraulic Hose, Non-conductive | 538DM | | |
| N | Fiber | U | 100R7 | MSHA | A-49 | SAE 100R7 - Hydraulic Hose | 540N | | |
| O | Fiber | U | 100R7 | FDA | A-50 | SAE 100R7 Specialty Water Hose | 540P | | |
| H | Fiber | H | 100R7 | | A-52 | SAE 100R7 Low Temperature Hydraulic Hose | 55LT | | |
| N | Fiber | U | - | MSHA*** | A-53 | Diagnostic Hose | 56DH | | |
| N | Fiber | U | - | MSHA***, DNV | A-54 | Fast Response Hydraulic Hose | 575X/575XN | | |
| U | Fiber | U | - | SAE J517 | A-54 | Fast Response Hydraulic Hose | 578X | | |
| N | Fiber | U | 100R8 | MSHA, DNV | A-55 | SAE 100R8 High Pressure Hydraulic 588N - Non-conductive | 580N/588N | Fittings | |
| N | Fiber | U | - | | A-57 | High Temperature Power Cleaning | 1035HT | | |
| U | Fiber | U | UL94HB | MSHA | A-56 | DuraGard™ General Purpose Polyurethane | 83FR | | |
| U | Fiber | U | - | | A-58 | General Purpose Transfer Hose | B9 | | |
| N | Fiber | U | - | ANSI CSA NGV 4.2; ECE R110***; NFPA 52; CSA 12.52 Class A, Class D, Class B*** | A-59 | Compressed Natural Gas Hose | 5CNG | | |
| N | Fiber | N | - | ECE R67 Class 1, ECE R110 CNG Class 6, CSA Certified | A-61 | Propane & Natural Gas Hose | 8LPG | | |
| N and H | Fiber | U | 100R7 (HLBD) | MSHA, ISO 3949 (HLBD) | A-62 | SAE 100R7 Hydraulic & Lubrication Hose | HLB/HLBD | | |
| N | Fiber | U | - | | A-63 | Marine Steering Hose | MSH | | |
| N | Fiber | U | - | | A-64 | Fast Response Marine Steering Hose | MSXL | | |
| N | Fiber / SS Wire | U | - | | A-65 | Marine Power Tilt Hose | PTH | | |
| N | Fiber | U | - | | A-66 | Sewer Cleaning - Lateral Cleaning | S5N | Tooling, Equipment & Accessories | |
| H | Fiber | U | - | | A-67 | Sewer Cleaning | S6 | | |
| H | Fiber | U | - | | A-68 | Sewer Cleaning | S9 | | |

***View Government & Agency Specifications for exceptions, pg. A-7

| | | | |
|---------------|-----------------------------|------------------|---------------------------------|
| Legend | F - Fiber | H - Copolyester | U - Polyurethane |
| | N - Nylon | O - Polyethylene | UTJ - TOUGHJACKET™ Polyurethane |
| | R - Smooth Synthetic Rubber | S - Silicone | X - TPV |

Tubing Thermoplastic
B

Coiled Air Hose & Fittings
C

Transportation
D

Fittings
E

Tooling, Equipment & Accessories
F

General Technical
G

Construction/Specifications

Fluoropolymer Hose, MPa

A Hose

B Tubing Thermoplastic

C Coiled Air Hose & Fittings

D Transportation

E Fittings

F Tooling, Equipment, & Accessories

G General Technical

| Reinforcement Type | | PSI Fluoropolymer Hose Working Pressures | | | | | | | | | | | | | | |
|--------------------|-------------|--|-----|---------------|------|------|------|-------|------|------|-----|-------|------|------|------|-----|
| | | Fractional Size | | Nominal Sizes | | | | | | | | | | | | |
| | | | | 1/8 | 3/16 | 1/4 | 5/16 | 13/32 | 1/2 | 5/8 | 7/8 | 1-1/8 | 1/8 | 1/4 | 3/8 | 1/2 |
| | | Dash Size | | -3 | -4 | -5 | -6 | -8 | -10 | -12 | -16 | -20 | -3 | -4 | -6 | -8 |
| Hose | Description | MPa | MPa | MPa | MPa | MPa | MPa | MPa | MPa | MPa | MPa | MPa | MPa | MPa | MPa | |
| Wire | 919 | PTFE Hose | | 20.7 | 20.7 | 17.2 | 13.8 | 10.3 | 8.3 | 6.9 | 4.3 | | | | | |
| | 919B | PTFE Hose with static-dissipative core | | 20.7 | 20.7 | 17.2 | 13.8 | | | | | | | | | |
| | 919J | Silicone Covered PTFE Hose | | 20.7 | 20.7 | 17.2 | 13.8 | 10.3 | 8.3 | 6.9 | | | | | | |
| | 919BJ | Silicone Covered PTFE Hose with static-dissipative core | | 20.7 | 20.7 | 17.2 | 13.8 | 10.3 | 8.3 | 6.9 | | | | | | |
| | 919U | High Abrasion Resistance PTFE Hose | | 20.7 | | 17.2 | 13.8 | | | | | | | | | |
| | 929 | Heavy Wall PTFE Hose | | 20.7 | | 17.2 | 13.8 | | | | | | | | | |
| | 929B | Heavy Wall PTFE Hose with static-dissipative core | | 20.7 | | 17.2 | 13.8 | | 8.3 | 8.6 | | | | | | |
| | 929BJ | Silicone Covered PTFE Hose with static-dissipative core | | 20.7 | | 17.2 | 13.8 | | 8.3 | 8.6 | | | | | | |
| | 939 | Convuluted PTFE Hose | | | | | | | | | | | | 10.3 | 9.3 | 6.9 |
| | 939B | Convuluted PTFE Hose with static-dissipative core | | | | | | | | | | | | 10.3 | 9.3 | 6.9 |
| Other | 944B | High Pressure PTFE Hose with static-dissipative core | | | | 31.0 | 31.0 | 27.6 | 27.6 | 27.6 | | | | | | |
| | 955B | High Pressure PTFE Hose with static-dissipative core | | 37.9 | | 37.9 | 37.9 | 37.9 | 37.9 | 37.9 | | | | | | |
| | STW Z-STW* | PAGE Heavy Wall PTFE Hose *Double Braid | | | | | | | | | | 20.7 | 20.7 | 13.8 | 12.1 | |
| | STB Z-STB* | PAGE Heavy Wall PTFE Hose with static-dissipative core *Double Braid | | | | | | | | | | 20.7 | 20.7 | 13.8 | 12.1 | |
| | SCW | PAGE Convuluted PTFE Hose | | | | | | | | | | | 10.3 | 10.3 | 10.3 | |
| | SCB | PAGE Convuluted PTFE Hose with static-dissipative core | | | | | | | | | | | 10.3 | 10.3 | 10.3 | |
| | SCWV | PAGE Heavy Wall Convuluted PTFE Hose | | | | | | | | | | | | | 10.3 | |
| | SCBV | PAGE Heavy Wall Convuluted PTFE Hose with static-dissipative core | | | | | | | | | | | | | 10.3 | |
| | NCW | PAGE Nomex Braid Convuluted | | | | | | | | | | | 5.0 | 2.8 | 1.9 | |
| | NCB | PAGE Nomex Braid Convuluted with static-dissipative core | | | | | | | | | | | 5.0 | 2.8 | 1.9 | |

*Z indicates double braid for sizes over 1".

Legend

PTFE - Polytetrafluoroethylene

PTFE-S - Polytetrafluoroethylene, Static Dissipative

U - Polyurethane

NB - Nomex Braid

PP - Polypropylene

S - Silicone

Construction/Specifications

Fluoropolymer Hose, MPa

| PSI Fluoropolymer Construction and Specifications | | | | | | | | | | | | | | Reinforcement Type |
|---|-----|------------|-------|------|-------|-----|-----|-----------|------------------------|----------------|--------|-----------------|--|--------------------|
| 3/4 | 1 | 1 1/4 | 1 1/2 | 2 | 2-1/2 | 3 | 4 | | | | | Fractional Size | | |
| -12 | -16 | -20 | -24 | -32 | -40 | -48 | -64 | Core Tube | Reinforcement Material | Cover Material | Page # | Description | Hose | |
| MPa | MPa | MPa | MPa | MPa | MPa | MPa | MPa | | | | | | | |
| | | | | | | | | | PTFE | SS Wire | — | A-69 | PTFE Hose | 919 |
| | | | | | | | | | PTFE-S | SS Wire | — | A-69 | PTFE Hose with static-dissipative core | 919B |
| | | | | | | | | | PTFE | SS Wire | S | A-70 | Silicone Covered PTFE Hose | 919J |
| | | | | | | | | | PTFE-S | SS Wire | S | A-70 | Silicone Covered PTFE Hose with static-dissipative core | 919BJ |
| | | | | | | | | | PTFE | SS Wire | U | A-71 | High Abrasion Resistance PTFE Hose | 919U |
| | | | | | | | | | PTFE | SS Wire | — | A-72 | Heavy Wall PTFE Hose | 929 |
| | | | | | | | | | PTFE-S | SS Wire | — | A-72 | Heavy Wall PTFE Hose with static-dissipative core | 929B |
| | | | | | | | | | PTFE-S | SS Wire | S | A-73 | Silicone Covered PTFE Hose with static-dissipative core | 929BJ |
| | 7.6 | 6.9 | 6.9 | 5.2 | 1.7 | | | | PTFE | SS Wire | — | A-74 | Convoluted PTFE Hose | 939 |
| | 7.6 | 6.9 | 6.9 | 5.2 | 1.7 | | | | PTFE-S | SS Wire | — | A-74 | Convoluted PTFE Hose with static-dissipative core | 939B |
| | | | | | | | | | PTFE-S | SS Wire | — | A-75 | High Pressure PTFE Hose with static-dissipative core | 944B |
| | | | | | | | | | PTFE-S | SS Wire | — | A-76 | High Pressure PTFE Hose with static-dissipative core | 955B |
| | 6.9 | 6.9 8.3 | 6.9* | 6.2* | | | | | PTFE | SS Wire | — | A-77 | PAGE Heavy Wall PTFE Hose *Double Braid | STW Z-STW* |
| | 6.9 | 6.9 8.3 | 6.9* | 6.2* | | | | | PTFE-S | SS Wire | — | A-77 | PAGE Heavy Wall PTFE Hose with static-dissipative core *Double Braid | STB Z-STB* |
| | 8.3 | 6.4 | 5.2 | 4.5 | 3.1 | | | | PTFE | SS Wire | — | A-78 | PAGE Convoluted PTFE Hose | SCW |
| | 8.3 | 6.4 | 5.2 | 4.5 | 3.1 | | | | PTFE-S | SS Wire | — | A-78 | PAGE Convoluted PTFE Hose with static-dissipative core | SCB |
| | 8.3 | 6.9 | 5.2 | 4.5 | 3.1 | 1.4 | 1.2 | 1.0 | PTFE | SS Wire | — | A-79 | PAGE Heavy Wall Convoluted PTFE Hose | SCW |
| | 8.3 | 6.9 | 5.2 | 4.5 | 3.1 | 1.4 | 1.2 | 1.0 | PTFE-S | SS Wire | — | A-79 | PAGE Heavy Wall Convoluted PTFE Hose with static-dissipative core | SCBV |
| | 1.4 | 1.4 | | | | | | | PTFE | NB | — | A-81 | PAGE Nomex® Braid Convoluted | NCW |
| | 1.4 | 1.4 | | | | | | | PTFE-S | NB | — | A-81 | PAGE Nomex® Braid Convoluted with static-dissipative core | NCB |

*Z indicates double braid for sizes over 1".

Legend

PTFE - Polytetrafluoroethylene

PTFE-S - Polytetrafluoroethylene, Static Dissipative

U - Polyurethane

NB - Nomex Braid

PP - Polypropylene

S - Silicone

Selection of Hose Diameter

Flow Capacities at Recommended Flow Velocities

The nomogram below is provided as an aid in determining the correct hose size.

How to use the nomogram:

Determine the proper flow rate your system requires, then connect a straight edge from the selected flow rate to the recommended velocity range. The required hose I.D. will appear at the intersection of the straight edge and the center column. If the straight edge passes through the scale between sizes listed, use the next larger I.D. hose.

Example: Locate 16 gallons per minute in the left-hand column and 20 feet per second (fps) in the right-hand column (the maximum recommended velocity range for pressure lines). Lay a straight edge across these two points. The inside diameter required is shown in the center column at or above the straight edge. In this case, we need a hose I.D. of 0.625 (5/8") inch (or larger).

Use the same procedure for suction of return lines, except utilizing their respective maximum recommend velocities.

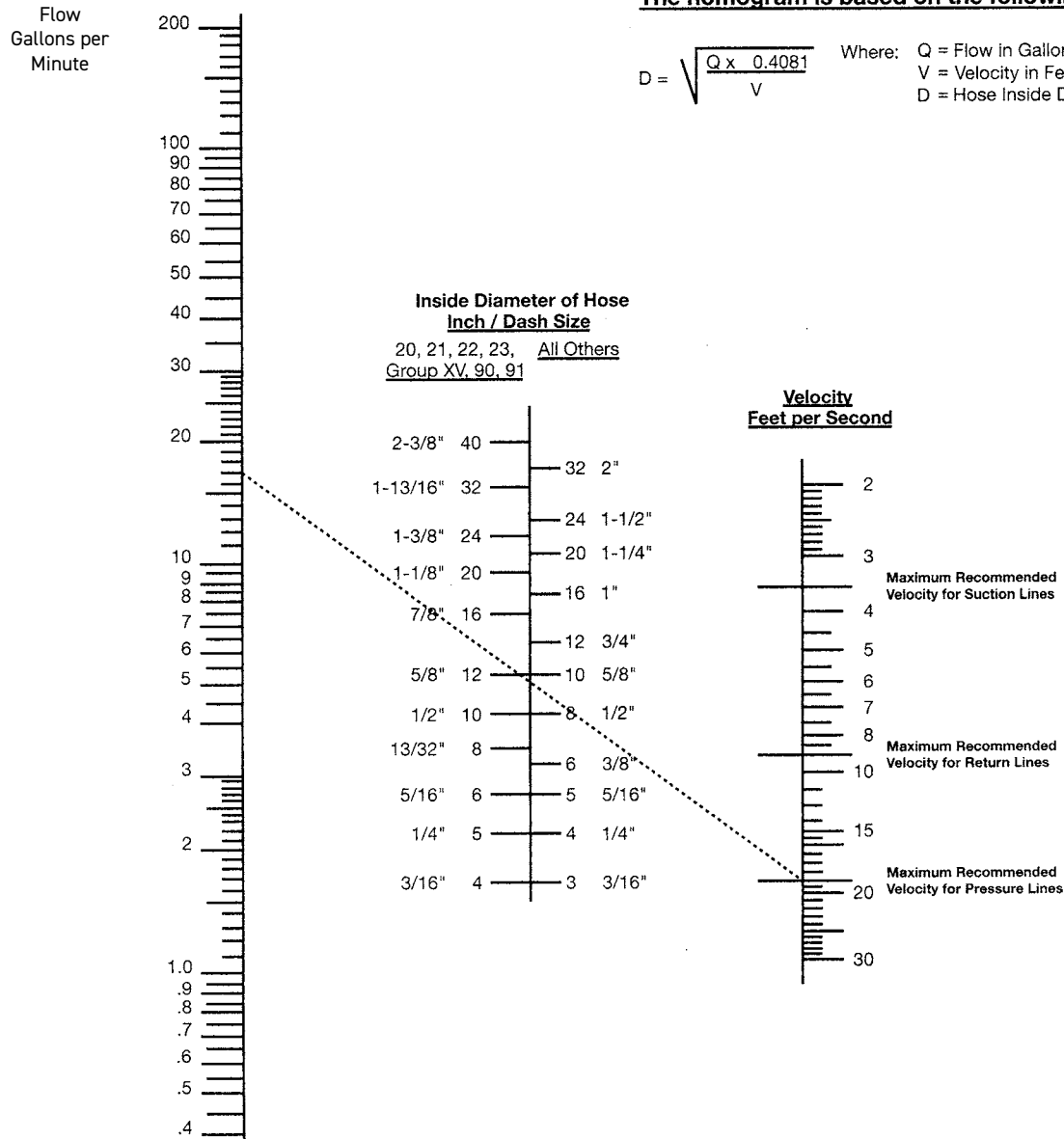

The nomogram is based on the following formula:

$$D = \sqrt{\frac{Q \times 0.4081}{V}}$$

Where: Q = Flow in Gallons per Minute (gpm)
V = Velocity in Feet per Second (ft/sec)
D = Hose Inside Diameter (inches)

Calculation of Hose Length

For Over-the-Sheave applications

The exact cut-off length for an optimum over-the-sheave assembly depends on the particular mechanical arrangement of the machine. A method for finding an approximate starting point is as follows:

1. Assemble hose with one coupling as shown in diagram.
2. Measure hose length from point 1 to point 2 with hose taut. $LO = \text{length}$
3. Calculation of insert allowance (x) may be found from the coupling dimension tabulations in the fittings section or from direct measurement on the coupling. A 1.5% stretch allowance is provided in the following formula.
4. Calculate hose cutoff hose cut length HCL: $HCL = 0.985 LO + 2X$
Where HCL includes coupling, insert allowance on both ends.
5. Couple the remaining hose end, check crimp, and assemble on the machine.

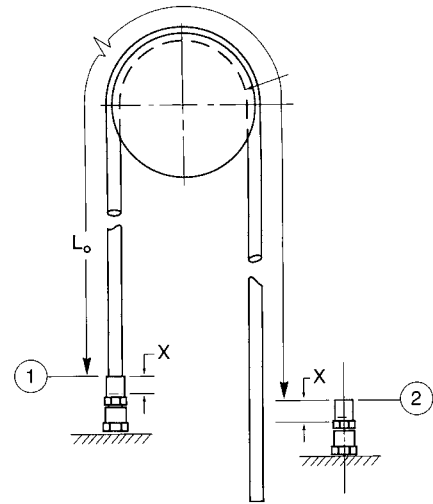

Selecting The Correct Hose

"STAMPED"

S

Size

The appropriate inside and outside diameters

T

Temperature

The ambient and minimum/maximum temperature of the material being conveyed

A

Application

External conditions including abrasion, climate, heat, flexing, routing and degrees of bending

M

Media

The composition of the substance being conveyed and chemical compatibility with the hose inner core and, if applicable, the outer cover

P

Pressure

The maximum vacuum or pressure of the system, including pressure spikes

E

End

The appropriate end connection, material and attachment method for the application

D

Delivery

Testing, quality, packaging, and delivery requirements

Hose Material Features

Core, Reinforcement & Jacket

Attributes Parflex Hose - Hose Core Tubes

| | Material | Maximum Working Temperature | Features |
|-----------|--------------|--|--|
| Core Tube | Copolyester | Working Temperature: ranging from -70°F (-57°C) to 250°F (127°C)* | <ul style="list-style-type: none"> Good chemical resistance Superior flexibility in cold temperatures |
| | Nylon | Working Temperature: ranging from -40°F (-40°C) to 230°F (110°C)* | <ul style="list-style-type: none"> Very good chemical resistance Maximum resistance to permeable fluids |
| | Polyethylene | Working Temperature: ranging from -40°F (-40°C) to 150°F (66°C)* | <ul style="list-style-type: none"> Non-leaching Low moisture absorption |
| | Polyurethane | Working Temperature: ranging from -40°F (-40°C) to 200°F (93°C)* | <ul style="list-style-type: none"> Excellent flexibility |
| | PTFE | Working Temperature: ranging from -100°F (-73°C) to 500°F (260°C)* | <ul style="list-style-type: none"> Chemically inert, superior chemical resistance Lowest coefficient of friction Superior dielectric strength Exceptional heat resistance Non wetting |

Attributes Parflex Hose - Hose Reinforcements

| | Material | Maximum Working Temperature | Features |
|---------------|--------------------------|--|---|
| Reinforcement | Fiber | Working Temperature: ranging from -70°F (-57°C) to 250°F (127°C)* | <ul style="list-style-type: none"> High density braid allows for compact braid O.D. Maximum impulse life Excellent flexibility |
| | Steel Stainless Steel | Working Temperature: ranging from -100°F (-73°C) to 500°F (260°C)* | <ul style="list-style-type: none"> Low volumetric expansion Maximum strength reinforcement |
| | Polypropylene | Working Temperature: ranging from 0°F (18°C) to 100°F (212°C)* | <ul style="list-style-type: none"> Light weight Excellent corrosion resistance |
| | Nomex | Working Temperature: ranging from -100°F (-73°C) to 400°F (204°C)* | <ul style="list-style-type: none"> Very light weight Eliminates RFI issues Superior flexibility |

Attributes Parflex Hose - Hose Covers

| | Material | Maximum Working Temperature | Features |
|-------|--------------|---|--|
| Cover | Copolyester | Working Temperature: ranging from -70°F (-57°C) to 250°F (121°C)* | <ul style="list-style-type: none"> Low coefficient of friction Superior flexibility in cold temperatures |
| | Polyurethane | Working Temperature: ranging from -40°F (-40°C) to 200°F (93°C)* | <ul style="list-style-type: none"> Abrasion resistant Non-marring |
| | Silicone | Working Temperature: ranging from -65°F (-54°C) to 450°F (232°C)* | <ul style="list-style-type: none"> Abrasion resistant Protects braiding Keeps hose cooler for operator safety |
| | TPV | Working Temperature: ranging from -40°F (-40°C) to 250°F (121°C)* | <ul style="list-style-type: none"> Extremely durable Resistant to chemicals and weathering |

Notes: *Temperatures listed are maximum and minimums typically associated with this material. However, other factors in the manufacturing process may limit the working temperature. Refer to the specific hose page for actual hose working temperature.

Hose Material Overview

Materials to Parflex Hose

Materials to Parflex Hose - Hose Core Tubes

| Material Code for Hose Core Tubes | Material Name | Hose |
|-----------------------------------|--------------------|--|
| H | Copolyester | D6R, HFS2R, R6HTBR, 560TJ, 563LT, 563TJ, 590TJ, 594TJ, 510C, 518C, 53DM/538DM, 55LT, HLB, HLBD, S6, S9 |
| N | Nylon | 510D, 518D, 520N, 527BA, 528N, 53DM, 540N, 56DH, 575X, 575XN, 578X, 580N, 588N, 1035HT, 5CNG, MSH, MSXL, PTH, S5N, 1035HT, CNGRP |
| O | Polyethylene | 540P |
| PTFE | Fluoropolymer PTFE | 919/919B, 919J, 919BJ, 919U, 929/929B, 929BJ, 939/939B, 944B, 955B, STW/STB, SCW/SCB, NCW/NCB, SCWV/SCBV |
| U | Polyurethane | 83FR, B9 |

Materials to Parflex Hose - Hose Covers

| Material Code for Hose Covers | Material Name | Hose |
|-------------------------------|---------------------------------|--|
| H | Low Temperature Copolyester | 55LT, 53DM/538DM, 563LT |
| M | Silicone | 919J, 919BJ, 929BJ |
| U | Polyurethane, Elastomeric Nylon | 560TJ, 563TJ, 590TJ, 594TJ, 510C, 518C, 518D, 520N, 528N, 527BA, 540N, 540P, 56DH, 575X, 578X-12, 580N, 588N, 83FR, 1035HT, B9, 5CNG, HLB, HLBD, MSH, PTH, S5N, S6, S9 |
| UTJ | Polyurethane TOUGHJACKET | 560TJ, 563TJ, 578X-4, 578X-6, 590TJ, 594TJ |
| N | Flexible Nylon | 575XN |
| TPV | Thermoplastic Vulcanizate | CNGRP |

Rating Codes

- G Good to excellent. Little or no swelling, tensile or surface changes. Preferred choice.
- L Marginal or conditional. Noticeable effects but not necessarily indicating lack of serviceability. Further testing suggested for specific application. Very long-term effects such as stiffening or potential for crazing should be evaluated.
- P Poor or unsatisfactory. Not recommended without extensive and realistic testing.
- – Indicates that this was not tested.
- # For fluoropolymer. Indicates good chemical resistance but potential for excessive permeation.
- 2 See notes pg. A-25.
- 3 See notes pg. A-25.
- 4 See notes pg. A-25.
- 5 See notes pg. A-25.
- 6 See notes pg. A-25.
- 7 See notes pg. A-25.
- 8 See notes pg. A-25.

Compatibility Guide

Media to Hose Material

Media to Hose Material

| Media | H | N | U/UTJ | PTFE | M | TPV |
|-------------------------------------|-----|-----|-------|------|---|-----|
| Acetaldehyde | G | L | L | G | P | L |
| Acetic Acid Glacial | L | L | L | G | L | L |
| Acetone | L | G | P | G | P | L |
| Acetylene | (2) | (2) | (2) | (2) | P | P |
| Air (4) | G | G | G | G | G | G |
| Ammonium Chloride | G | P | G | G | P | G |
| Ammonium Hydroxide | L | G | P | G | G | G |
| Anhydrous Ammonia | P | P | P | (8) | P | G |
| Aniline | P | P | P | G | P | L |
| Animal Oils (6) | G | G | G | G | P | P |
| Aromatic Hydrocarbons | L | G | L | G | P | P |
| Asphalt | G | G | G | G | P | L |
| Baygon (Insecticide) | L | G | P | G | - | - |
| Beer | G | G | G | G | G | G |
| Benzene | L | G | L | G | P | P |
| Brake Fluid (DOT #3) | - | G | P | G | P | L |
| Butane (2) (4) | G | G | L | # | P | P |
| Butter (6) | G | G | G | G | P | P |
| Calcium Chloride | G | (3) | G | G | G | G |
| Carbon Dioxide (4) | G | G | G | # | L | G |
| Carbon Monoxide (4) | G | (3) | G | # | G | G |
| Carbon Tetrachloride | L | G | P | G | P | P |
| Castor Oil | G | L | L | G | G | L |
| Chlorinated Hydrocarbon Base Fluids | L | G | L | G | P | P |
| Chlorinated Petroleum Oil | G | G | L | - | P | P |
| Chlorinated Solvents | P | (3) | P | G | P | P |
| Chlorine, Gaseous, Dry | P | P | P | # | P | P |
| Chlordane (Insecticide) | L | G | P | - | P | P |
| Chloroform | P | P | P | G | P | P |
| Chromic Acid | P | (3) | P | G | P | P |
| Citric Acid Solutions | G | G | L | G | G | G |
| Crude Petroleum Oil | G | G | G | G | P | P |
| Cyclohexane (2) | G | G | G | G | P | P |
| Cygon (Insecticide) | L | G | P | - | - | - |
| Diazion (Insecticide) | L | - | P | - | P | P |
| Diesel Fuel (2) | G | G | G | G | P | P |
| Diester Oils | L | G | P | G | P | P |
| Enamels | G | G | G | G | - | - |
| Ethanol (6) | G | G | L | G | P | G |
| Ethers | L | G | P | G | P | P |
| Ethylene Glycol | L | G | L | G | G | G |
| Ethylene Oxide | G | G | L | # | P | G |
| Fatty Acids | G | G | (3) | G | P | L |
| Formaldehyde | L | L | P | G | P | G |
| Formic Acid | P | P | P | G | P | G |

Rating Code - pg. A-21
Notes - pg. A-25

(Cont.)

Tubing
Thermoplastic

Coiled Air Hose
& Fittings

Transportation

Fittings

Tooling, Equipment,
& Accessories

General Technical

Compatibility Guide

Media to Hose Material

Media to Hose Material

| Media | H | N | U/UTJ | PTFE | M | TPV |
|---|-----|-----|-------|------|---|-----|
| Freon 12 (5) | P | G | L | # | P | P |
| Freon 22 (5) | P | G | L | # | P | P |
| Fruit Juices | G | G | G | G | G | G |
| Fuel Oil (2) | G | G | L | G | P | P |
| Gas (Oil) (2) | G | G | G | G | P | P |
| Gas (Natural) (4) | (2) | (2) | (2) | (2) | P | P |
| Gasoline (2) | G | G | (3) | G | P | P |
| Glue | (3) | (3) | (3) | (3) | G | G |
| Glycerin | G | G | L | G | G | G |
| Glycols (to 135°F) | L | G | L | G | G | L |
| Grease (Petroleum base) | G | G | G | G | P | P |
| Heptachlor (Insecticide) | L | G | P | G | - | - |
| Hexane (2) | G | G | G | G | P | L |
| Houghto Safe-600 Series (Hydraulic fluid) | G | G | L | G | L | G |
| Houghto Safe-1000 Series (Phosphate esters) | L | G | P | G | P | G |
| Hydraulic Fluid (Petroleum base) | G | G | G | G | P | P |
| Hydraulic Fluid (Phosphate ester base) | L | G | L | G | P | G |
| Hydraulic Fluid (Water glycol base) | G | G | G | G | P | L |
| Hydraulic Oil (Petroleum base) | G | G | G | G | P | P |
| Hydrochloric Acid | P | L | P | G | P | L |
| Hydrofluoric Acid | P | P | P | G | P | P |
| Hydrogen, Gaseous (2) (4) (5) | G | G | G | - | P | G |
| Hydrolube (Hydraulic fluid/water glycol base) | G | G | L | G | P | G |
| IRUS 902 (Hydraulic fluid/water-oil emulsion) | G | G | G | G | - | - |
| Isocyanates (2) | L | L | L | G | - | - |
| IsoOctane (2) | G | G | G | G | P | P |
| Isopropyl Alcohol | G | G | L | G | G | L |
| Kerosene (2) | G | G | L | G | P | P |
| Ketones | L | G | P | G | P | P |
| Lacquer Solvents | L | G | P | G | P | P |
| Lactic Acid | P | G | P | G | L | G |
| Lime (Calcium oxide) | G | G | G | G | P | G |
| Lindol (Hydraulic fluid/phosphate esters) | L | G | P | G | G | G |
| Linseed Oil | G | G | G | G | G | L |
| LP - Gas | (2) | (2) | (2) | (2) | P | P |
| Lubricating Oils (Diester base) | L | G | P | G | P | P |
| Lubricating Oils (Petroleum base) | G | G | G | G | P | P |
| Malathion (Insecticide) | L | G | P | G | P | - |
| Magnesium Hydroxide | L | G | L | G | P | G |
| Magnesium Salts | - | G | G | G | G | G |
| Mercury | G | G | G | G | G | G |
| Meropa Oil (Sulphur base) | G | G | - | G | - | - |
| Methane | (2) | (2) | (2) | (2) | P | P |
| Methanol | G | G | P | G | G | G |
| Methoxychlor (Insecticide) | L | G | P | G | - | - |

Rating Code - pg. A-21
Notes - pg. A-25

(Cont.)

Compatibility Guide

Media to Hose Material

A Hose

Media to Hose Material

| Media | H | N | U/UTJ | PTFE | M | TPV |
|--|-----|-----|-------|------|---|-----|
| Methyl Alcohol (6) | G | G | P | G | G | G |
| Methylene Chloride | P | L | P | G | P | P |
| Methyl Ethyl Ketone (MEK) | L | G | P | G | P | P |
| Methyl Ethyl Ketone Peroxide (MEKP) | - | L | P | G | L | - |
| Methyl Isobutyl Ketone (MIBK) | L | G | P | G | P | P |
| Milk (6) | G | G | G | G | G | G |
| Mineral Oil | G | G | G | G | P | P |
| Mineral Spirits | P | - | L | G | P | L |
| Motor Oils | G | G | G | G | P | - |
| Naphtha | L | G | P | G | P | P |
| Natural Gas (4) | (2) | (2) | (2) | (2) | P | P |
| Nitric Acid | P | P | P | G | P | P |
| Nitrobenzene | P | G | P | G | P | L |
| Nitrogen, Gaseous (4) (5) | G | G | G | G | G | G |
| Nitrous Oxide | - | L | - | # | G | - |
| Oil (SAE) | G | G | G | G | L | P |
| Oil of Turpentine | G | G | P | G | P | P |
| Oleic Acid | G | G | G | G | P | L |
| OS 45 Type 3 Hydraulic Fluid (Silicate esters) | L | G | L | - | P | - |
| Oxygen, Gaseous (4) (5) (6) | G | G | G | G | G | G |
| Ozone | L | P | L | G | G | G |
| Paint Solvents (Oil base) | L | G | L | G | - | L |
| Paint (Oil Base) (7) | G | G | G | G | P | P |
| Pentane (2) | G | G | L | G | P | G |
| Perchloric Acid | P | P | P | G | P | P |
| Perchloroethylene | P | P | P | G | P | P |
| Petroleum Ether | - | (2) | (2) | (2) | P | - |
| Petroleum Oils | G | G | G | G | P | P |
| Phenols | P | P | P | G | - | P |
| Phosphate Esters (above 135°F) | P | G | P | G | P | G |
| Phosphate Esters (to 135°F) | G | G | P | G | P | G |
| Polyol Esters | L | G | P | G | P | P |
| Potassium Hydroxide, 50% | P | P | P | G | G | G |
| Propane (4) (5) | (2) | (2) | (2) | (2) | P | P |
| Propylene Glycol | - | - | G | G | G | G |
| Pydraul F-9, 150, 160 (to 135°F) | G | G | P | G | - | P |
| Pydraul 312C, 625 (to 135°F) | P | G | P | G | P | P |
| Quintolubric 822 Fluid | - | G | G | G | - | - |
| Salt Water | (3) | (3) | (3) | G | G | G |
| Sevin (Insecticides in water) | G | G | G | G | - | - |
| Silicone Greases | G | G | G | G | P | L |
| Silicone Oils | G | G | G | G | P | L |
| Skydrol 500 & 7000 | L | G | P | G | P | L |
| Soap Solutions | G | G | G | G | G | G |

Rating Code - pg. A-21
Notes - pg. A-25

(Cont.)

B Tubing Thermoplastic

C Coiled Air Hose & Fittings

D Transportation

E Fittings

F Tooling, Equipment, & Accessories

G General Technical

Compatibility Guide

Media to Hose Material

Media to Hose Material

| Media | H | N | U/UTJ | PTFE | M | TPV |
|--|-----|-----|-------|------|---|-----|
| Soda Water | G | G | G | G | G | G |
| Sodium Borate | G | G | G | G | G | G |
| Sodium Carbonate | (3) | (3) | (3) | (3) | G | G |
| Sodium Chloride Solutions | G | G | G | G | G | G |
| Sodium Hydroxide, 50% | L | P | P | G | G | G |
| Sodium Hypochlorite | L | P | P | G | P | G |
| Steam | P | P | P | G | P | G |
| Stoddard Solvent | P | G | P | G | P | P |
| Straight Synthetic Oils (Phosphate esters) | L | G | P | G | P | G |
| Sulfur | G | G | G | G | P | L |
| Sulfur Dioxide | P | L | L | G | P | G |
| Sulfur Hexafluoride Gas (4) (5) | G | G | G | G | P | L |
| Sulphuric Acid | P | P | P | G | P | P |
| Toluene | L | G | L | G | P | P |
| Toloul | L | G | L | G | - | - |
| Transmission Fluid | G | G | G | G | P | P |
| Trichloroethylene | P | L | P | G | P | P |
| Trisodium Phosphate Solutions | L | G | P | G | G | G |
| Turpentine | G | G | L | G | P | P |
| Ucon (Hydraulic fluid-water glycol base) | G | G | L | G | G | L |
| Varnish | G | G | G | G | P | L |
| Vinegar (6) | L | G | L | G | G | G |
| Water (to 135°F) (6) | G | G | G | G | G | G |
| Water (above 135°F) (6) | P | G | P | G | G | G |
| Water Glycols (to 135°F) | L | G | L | G | G | - |
| Water Glycols (above 135°F) | P | P | P | G | G | - |
| Water in oil Emulsions (to 135°F) | G | G | L | G | P | - |
| Water in oil Emulsions (above 135°F) | P | G | P | G | P | - |
| Whiskey, Wines (6) | G | G | L | G | G | G |
| Wood Oils | G | G | L | G | P | L |
| Xylene | L | G | P | G | P | P |
| Zinc Chloride | G | G | G | G | G | G |

Rating Code - pg. A-21

Notes:

The Fluid Compatibility Guides are simplified rating tabulations based on immersion tests at 75°F (24°C). Higher temperatures tend to reduce ratings. Since final selection depends on pressure, fluid and ambient temperature and other factors not known to Parker Hannifin Co., no performance guarantee is expressed or implied. Ratings do not imply compliance with specialized codes such as FDA, NSF, CSA or UL and do not cover possible fluid discoloration, taste or odor effects. For conveying foodstuffs, use FDA sanctioned materials and for potable water, use NSF listed materials. For chemicals not listed, or for advice on particular applications, please consult pdf_support@support.parker.com

- (2) Hose applications for these fluids must take into account legal and insurance regulations. This does not imply ISO, CSA, ECE or UL compliance.
- (3) Satisfactory at some concentrations and temperatures, unsatisfactory in others.
- (4) For high pressure gases, the cover should be pinpricked and the pressure must not be released quickly. Chain or restrain the hose to prevent personal injury in the event of damage or failure.
- (5) Chemical compatibility does not imply low permeation rates. Consult the Parker factory for a suggestion for your specific requirement.
- (6) Does not imply NSF or FDA compliance.
- (7) Chemical compatibility does not imply acceptability for use in airless paint spray applications. These applications require a special conductive hose.
- (8) Fluoropolymers are chemically compatible with Anhydrous Ammonia. However, extreme caution must be used in dealing with Anhydrous Ammonia since it can cause severe injuries such as blindness and/or chemical burns.

Volumetric Expansion of Hose at Maximum Working Pressure

Hydraulic hoses expand under pressure. On some applications, customers can use the differences in expansion between hoses to tune systems for better performance or even noise reduction. Parflex has tested a select list of hoses and determined the rate of expansion in cubic centimeters per foot of hose (cc/ft). To calculate the volumetric expansion of a hose, substitute the desired pressure into the "X" values in the appropriate equation. For other hoses, please contact the division.

Volumetric Expansion (VE) of Hose

| Hose Part Number | VE at Max. Working Pressure | | Equation for Volumetric Expansion | |
|------------------|-----------------------------|-------|-----------------------------------|-------|
| | psi | cc/ft | Y=cc/ft | X=psi |
| 510C-3 | 3250 | 2.33 | Y=0.0007X+0.0581 | |
| 510C-4 | 3000 | 2.71 | Y=0.0009X+0.0059 | |
| 510C-5 | 2500 | 3.41 | Y=0.0013X+0.1647 | |
| 510C-6 | 2250 | 4.32 | Y=0.0019X+0.0471 | |
| 510C-8 | 2250 | 7.36 | Y=0.0032X+0.1637 | |
| 510C-12 | 1250 | 8.99 | Y = 0.00745x - 0.29910 | |
| 510C-16 | 1000 | 15.33 | Y = 0.01573x - 0.44928 | |
| 518C-3 | 3250 | 2.33 | Y=0.0007X+0.0581 | |
| 518C-4 | 3150 | 2.71 | Y=0.0009X+0.0059 | |
| 518C-5 | 3150 | 3.41 | Y=0.0013X+0.1647 | |
| 518C-6 | 3000 | 4.32 | Y=0.0019X+0.0471 | |
| 518C-8 | 3000 | 7.36 | Y=0.0032X+0.1637 | |
| 518C-12 | 1660 | 8.99 | Y = 0.00745x - 0.29910 | |
| 518C-16 | 1330 | 15.33 | Y = 0.01573x - 0.44928 | |
| 520N-3/528N-3 | 5000 | 1.13 | Y = 0.0002x + 0.1621 | |
| 520N-4/528N-4 | 5000 | 2.05 | Y = 0.00031x + 0.47589 | |
| 520N-5/528N-5 | 4500 | 2.63 | Y = 0.00048x + 0.48415 | |
| 520N-6/528N-6 | 4000 | 2.87 | Y = 0.00053x + 0.75151 | |
| 520N-8/528N-8 | 3500 | 3.64 | Y = 0.00086x + 0.64994 | |
| 53DM-4 | 3045 | 1.9 | Y = 0.00062x + 0.02373 | |
| 53DM-6/538DM-6 | 3045 | 3.19 | Y = 0.0010x + 0.0647 | |
| 53DM-8 | 3045 | 4.68 | Y = 0.0016x + 0.0384 | |
| 53DM-10 | 3045 | 9.82 | Y = 0.0033x - 0.2254 | |
| 540N-2 | 3000 | 1.11 | Y = 0.00036x + 0.04607 | |
| 540N-3 | 3000 | 1.75 | Y = 0.00057x + 0.03059 | |
| 540N-4 | 2750 | 2.33 | Y = 0.00079x + 0.14354 | |
| 540N-5 | 2500 | 3.46 | Y = 0.00124x + 0.31870 | |
| 540N-6 | 2250 | 4.06 | Y = 0.00174x + 0.15045 | |
| 540N-8 | 2000 | 6.05 | Y = 0.0030x + 0.0928 | |
| 540N-12 | 1250 | 10.26 | Y = 0.0081x - 0.2671 | |
| 560TJ-3 | 3626 | 0.575 | Y = 0.00017x + 0.00875 | |
| 560TJ-4 | 3263 | 0.757 | Y = 0.0002x + 0.1172 | |
| 560TJ-5 | 3118 | 0.729 | Y = 0.00021x + 0.09887 | |
| 560TJ-6 | 2750 | 1.33 | Y = 0.0004x + 0.1918 | |
| 560TJ-8 | 2500 | 1.98 | Y = 0.0007x + 0.2093 | |
| 560TJ-10 | 2000 | 3.04 | Y = 0.0012x + 0.5704 | |
| 560TJ-12 | 1750 | 3.07 | Y = 0.0015x + 0.4449 | |

Volumetric Expansion (VE) of Hose

| Hose Part Number | VE at Max. Working Pressure | | Equation for Volumetric Expansion | |
|------------------|-----------------------------|-------|-----------------------------------|-------|
| | psi | cc/ft | Y=cc/ft | X=psi |
| 575X-3 | 5000 | 1.69 | Y = 0.0003x + 0.2119 | |
| 575X-4 | 5000 | 2.05 | Y = 0.0003x + 0.5601 | |
| 520N-5/528N-5 | 4500 | 2.63 | Y = 0.00048x + 0.48415 | |
| 520N-6/528N-6 | 4000 | 2.87 | Y = 0.00053x + 0.75151 | |
| 520N-8/528N-8 | 3500 | 3.64 | Y = 0.00086x + 0.64994 | |
| 53DM-4 | 3045 | 1.9 | Y = 0.00062x + 0.02373 | |
| 520N-6/528N-6 | 4000 | 2.87 | Y = 0.00053x + 0.75151 | |
| 520N-8/528N-8 | 3500 | 3.64 | Y = 0.00086x + 0.64994 | |
| 53DM-4 | 3045 | 1.9 | Y = 0.00062x + 0.02373 | |
| 575X-6 | 5000 | 2.71 | Y = 0.0004x + 0.8412 | |
| 575XN-8 | 5000 | 4.59 | Y = 0.00064x + 1.41795 | |
| 575X-12 | 5000 | 12.52 | Y = 0.00192x + 2.92038 | |
| 575X-16 | 5000 | 16.81 | Y = 0.0028x + 2.9560 | |
| 590TJ-4 | 5076 | 0.888 | Y = 0.00016x + 0.09821 | |
| 590TJ-6 | 4061 | 1.87 | Y = 0.00038x + 0.32317 | |
| 590TJ-8 | 3553 | 2.17 | Y = 0.00049x + 0.43765 | |
| 590TJ-12 | 2500 | 4.2 | Y = 0.0013x + 0.8216 | |
| 590TJ-16 | 2030 | 6.21 | Y = 0.0026x + 1.0558 | |
| D6R04 | 3000 | 2.71 | Y = 0.0009x + 0.0059 | |
| D6R05 | 3000 | 1.28 | Y = 0.0003x + 0.3834 | |
| D6R06 | 3000 | 1.28 | Y = 0.0003x + 0.3834 | |
| D6R08 | 3000 | 2.88 | Y = 0.00057x + 1.20744 | |

The actual volumetric expansion achieved is influenced by multiple variables including fluid properties, hose routing and application temperature.

The volumetric expansion calculation is only a general guideline and must be verified by actual testing in the end-use application.

No performance warranty in design is expressed or implied by this calculation. Parker recommends that the user review and understand all the precautions listed in the Parker Safety Guide for Selecting and Using Hose, Fittings and Accessories, bulletin BUL. 4400-B.1.

Example: Find the volumetric expansion of 560-8 hose at 2000 psi

- From the chart, the appropriate equation would be $Y=0.0007x + 0.2093$
- Substituting: $Y=0.0007 * (2000) + 0.2093$
- Volumetric expansion "Y" = 1.60 cc/ft @ 2000 psi

Selection, Installation & Maintenance

Right/Wrong



- The routing of the hose assembly and the environment in which the hose assembly operates directly influence the service life of the hose assembly. The following diagrams indicate the correct routing of hose assemblies that will maximize its service life and assure a safe working functionality.
- When hose installation is straight, there must be enough slack in the hose to allow for changes in length that occur when pressure is applied. When pressurized, hose that is too short may pull loose from its hose fittings or stress the hose fitting connections, causing premature metallic or seal failures.
- The hose length must be determined so that the hose assembly has enough slack to allow the system components to move or vibrate without creating tension in the hose.
- However, do not allow too much slack and therefore introduce the risk of the hose snagging on other equipment or rubbing on other components.
- Mechanical straining of the hoses needs to be avoided, so the hose must not be bent below its minimum bend radius or twisted during installation. The minimum bending radii for each hose is stated in the hose tables in the catalogue.
- The plane of movement must also be considered and the hose routing selected accordingly.
- Hose routing also plays an important role on the selection of the hose fittings, as the correct fittings can avoid straining the hoses, unnecessary hose length or multiple threaded joints.
- Correct clamping (holding/supporting) of the hose should be exercised to securely route the hose or to avoid the hose contacting surfaces that will cause the hose damage. It is however, vital that the hose be allowed to keep its functionality as a "flexible-pipe" and not be restricted from changing in length when under pressure.

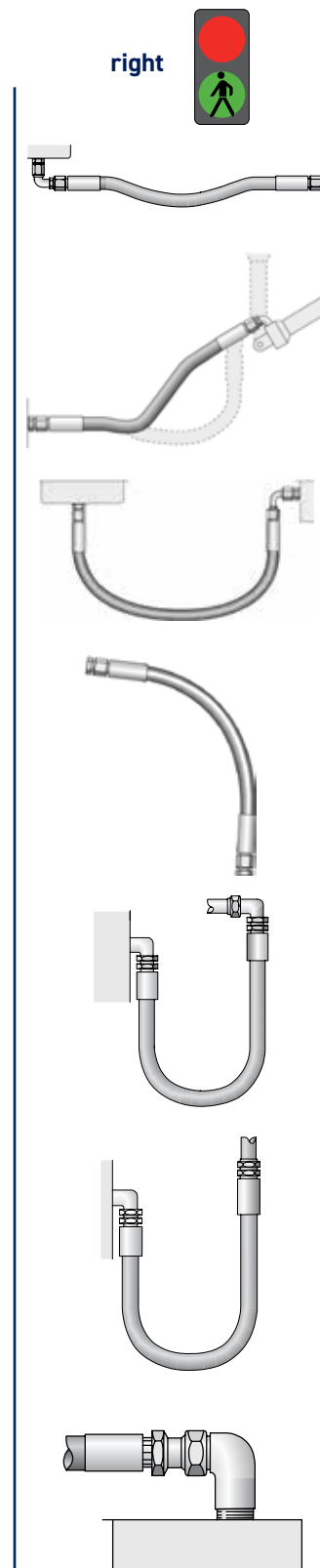

Selection, Installation & Maintenance

Right/Wrong

Tubing
Thermoplastic
B

Coiled Air Hose
& Fittings
C

Transportation
D

Fittings
E

Tooling, Equipment,
& Accessories
F

General Technical
G

wrong

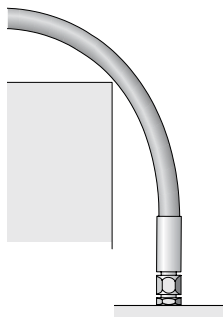
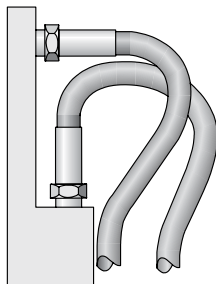
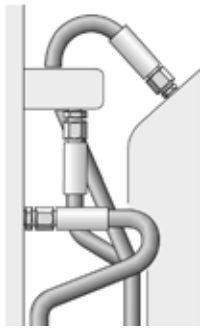
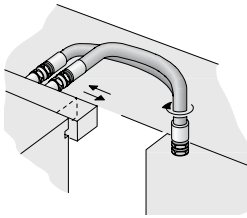
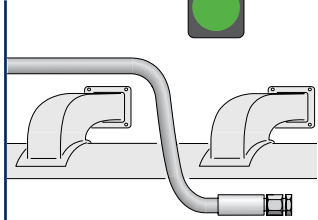

- It should also be noted that hoses for high- and low-pressure lines shall not be crossed or clamped together, as the difference in changes in length could wear the hose covers.
- Hose should not be bent in more than one plane. If hose follows a compound bend, it shall be coupled into separate segments or clamped into segments that each flex in only one plane.
- Hoses should be kept away from hot parts as high ambient temperatures shorten hose life. Protective insulation may need to be used in unusually high ambient temperature areas.
- While the importance of the functionality is primary, the aesthetics and practicality of the installation should also be considered in the design.
- Maintenance might be necessary at some point in the future, so prohibitive design routings should be avoided.

Abrasive Influences

In general care should be taken so that the hose is not exposed to direct surface contact that will cause abrasive wearing of the outer cover (either hose to object or hose to hose contact). If however, the application is such that this cannot be avoided, either a hose with a higher abrasion resistant hose cover or a protective sleeve need to be used.

right

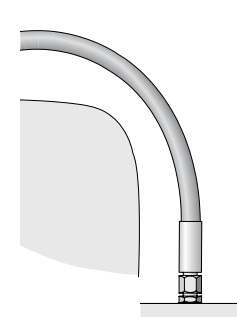
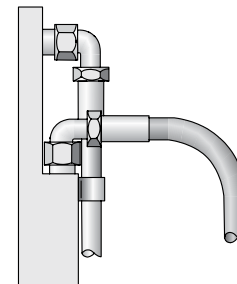
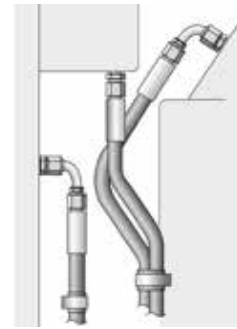
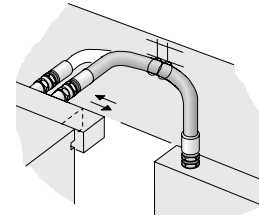
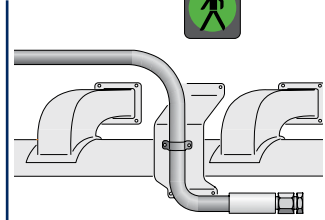

Nomenclature - Thermoplastic Hose

Parflex



| Product Family | Hose | | | Fitting Configuration* | Connection Size 1 | Connection Size 2 |
|---|----------------|--------------|---|---|-------------------|-------------------|
| F - Parkrimp (i.e. 56 series) | 1035HT | 56DH | HFS2R | 01 - Male Pipe Thread (with hex) - NPTF | -2 - 1/8 | -2 - 1/8 |
| | 510D | 575X/ | HTBR | 02 - Female Pipe Thread - NPT | -3 - 3/16 | -3 - 3/16 |
| | 518D | 575XN | | 03 - Male SAE (JIC) 37° Flare | -4 - 1/4 | -4 - 1/4 |
| A – Factory Crimp | 520N | 578X | MSH | 05 - Male Straight Thread w/ O-Ring | -5 - 5/16 | -5 - 5/16 |
| | 527BA | 580N | MSXL | 06 - Female SAE (JIC) 37° Swivel | -6 - 3/8 | -6 - 3/8 |
| | | | | 07 - Female Pipe Swivel | -8 - 1/2 | -8 - 1/2 |
| R – Field Attachable (i.e. 51 or 51R series) | 528N | 588N | PTH | 13 - Male Pipe Swivel - NPTF | -10 - 5/8 | -10 - 5/8 |
| | 53DM/ 538DM | 590TJ | S5N | 37 - Female SAE (JIC) 37° Swivel - 45° Elbow | -12 - 3/4 | -12 - 3/4 |
| | | | | 39 - Female SAE (JIC) 37° Swivel - 90° Elbow | -16 - 1 | -16 - 1 |
| | 540P | 5CNG | S6 | JC - Female Seal-Lok™ (ORFS) Swivel Short | -20 - 1-1/4 | -20 - 1-1/4 |
| | 55LT | 83FR | S9 | FU - Female JIS/BSP 30° Flare Swivel | | |
| | | | | MU - Metric Female JIS/BSP 30° Flare Swivel | | |
| | 563LT | B9 | | JO - Male Seal-Lok™ (ORFS) Rigid Strt w/O-Ring | | |
| | 560TJ | D6R | | GU - Female JIS/BSP Parallel Pipe Swivel (60° Cone) | | |
| | 563TJ | HLB/ HLBD | | JS - Female Seal-Lok™ (ORFS) Swivel | | |
| | | | | J7 - Female Seal-Lok™ (ORFS) Swivel - 45° Elbow | | |
| | | | J9 - Female Seal-Lok™ (ORFS) Swivel - 90° Elbow | | | |
| | | | TU - Universal Tube Stub | | | |
| | | | AL - A-Lok® Compression | | | |

Note: See pg. E-5 for detailed list of available fitting configurations. Please note that not all configurations are available in each fitting series.

| Hose Size | Fitting Material | Overall Length | Displacement Angle |
|-----------|---------------------|---|--|
| -2 - 1/8 | **No Material | Expressed | Specified only if two elbow fittings are used to construct hose assembly.* |
| -3 - 3/16 | Designation, Steel | in inches | |
| -4 - 1/4 | C = Stainless Steel | *Note: Face Seal type fittings are measured from sealing face. | |
| -5 - 5/16 | | | |
| -6 - 3/8 | | | |
| -8 - 1/2 | | | |
| -10 - 5/8 | | | |
| -12 - 3/4 | | | |
| -16 - 1 | | | |

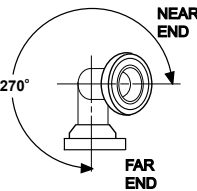

*Note:
*Starting with either end as the far end, measure the angle clockwise to describe the displacement of the near end.

Example: F540N0639121212C-52-##

F540N0639121212C-52-## – Parkrimp Hose Style

F540N0639121212C-52-## – Hose Series

F540N0639121212C-52-## – Fitting Configuration

06 = Female SAE JIC 37° Swivel

39 = Female SAE JIC 37° Swivel - 90° Elbow

F540N0639121212C-52-## – Connection Size 1 -12 = 3/4"

F540N0639121212C-52-## – Connection Size 2 -12 = 3/4"

F540N0639121212C-52-## – Hose Size -12 = 3/4"

F540N0639121212C-52-## – Fitting Material C= Stainless Steel

F540N0639121212C-52-## – Overall Hose Length 52 inches

F540N0639121212C-52-## – Displacement Angle Not used

Nomenclature - PTFE Hose

Series 919



| Product Family | Hose | | Fitting Configuration* | Connection Size 1 | Connection Size 2 | Hose Size | | |
|---------------------------------------|-----------|----------------------------------|---|-------------------|-------------------|-------------|------------|------------|
| P – Permanent Crimp (i.e. 91N series) | 919 | 919B | 01 - Male Pipe Thread (with hex) - NPTF | -4 - 1/4 | -4 - 1/4 | -4 - 3/16 | Series 919 | |
| | | | 02 - Female Pipe Thread - NPT | -5 - 5/16 | -5 - 5/16 | -5 - 1/4 | | |
| | 919J | 919BJ | 03 - Male SAE (JIC) 37° Flare | -6 - 3/8 | -6 - 3/8 | -6 - 5/16 | | |
| | | | 05 - Male Straight Thread w/ O-Ring | -8 - 1/2 | -8 - 1/2 | -8 - 13/32 | | |
| | | | 06 - Female SAE (JIC) 37° Swivel | -10 - 5/8 | -10 - 5/8 | -10 - 1/2 | | |
| R – Field Attachable (i.e. 90 series) | 919U | - | 07 - Female Pipe Swivel | -12 - 3/4 | -12 - 3/4 | -12 - 5/8 | | |
| | | 08 - Female SAE (JIC) 37° Swivel | -16 - 1 | -16 - 1 | -16 - 7/8 | | | |
| Factory Crimp (i.e. 94 series) | 929 | 929B | 13 - Male Pipe Swivel - NPTF | -20 - 1-1/4 | -20 - 1-1/4 | -20 - 1-1/8 | Series 929 | |
| | | | 14 - Female SAE (JIC) 37° Swivel - 45° Elbow | -24 - 1-1/2 | -24 - 1-1/2 | -24 - 1-1/8 | | |
| | 939 | 939B | 37 - Female SAE (JIC) 37° Swivel - 90° Elbow | -32 - 2 | -32 - 2 | -32 - 2 | | |
| | | | 41 - Female SAE (JIC) 37° Swivel - 90° Long Elbow | -6 - 3/8 | -6 - 3/8 | -6 - 3/8 | | |
| | 944B | 955B | JC - Female Seal-Lok™ (ORFS) Swivel Short | -8 - 1/2 | -8 - 1/2 | -8 - 1/2 | | Series 939 |
| | | | FU - Female JIS/BSP 30° Flare Swivel | -10 - 5/8 | -10 - 5/8 | -10 - 5/8 | | |
| | | | MU - Metric Female JIS/BSP 30° Flare Swivel | -12 - 3/4 | -12 - 3/4 | -12 - 3/4 | | |
| | | | JO - Male Seal-Lok™ (ORFS) Rigid Strt w/O-Ring | -16 - 1 | -16 - 1 | -16 - 1 | | |
| | | | GU - Female JIS/BSP Parallel Pipe Swivel (60° Cone) | -20 - 1-1/4 | -20 - 1-1/4 | -20 - 1-1/4 | | |
| | | | JS - Female Seal-Lok™ (ORFS) Swivel | -24 - 1-1/2 | -24 - 1-1/2 | -24 - 1-1/2 | | |
| | | | J7 - Female Seal-Lok™ (ORFS) Swivel - 45° Elbow | -32 - 2 | -32 - 2 | -32 - 2 | | |
| | | | J9 - Female Seal-Lok™ (ORFS) Swivel - 90° Elbow | -4 - 15/64 | -4 - 15/64 | -4 - 15/64 | | |
| TU - Universal Tube Stub | -6 - 5/16 | -6 - 5/16 | -6 - 5/16 | | | | | |
| AL - A-Lok® Compression | -8 - 7/16 | -8 - 7/16 | -8 - 7/16 | Series 944 | | | | |
| | -10 - 1/2 | -10 - 1/2 | -10 - 1/2 | | | | | |
| | | | -12 - 5/8 | -12 - 5/8 | -12 - 5/8 | Series 955 | | |
| | | | -16 - 29/32 | -16 - 29/32 | -16 - 29/32 | | | |

Note: See pg. E-5 for detailed list of available fitting configurations. Please note that not all configurations are available in each fitting series

| Fitting Material | Overall Length | Displacement Angle |
|----------------------------------|---------------------|--|
| **No Material Designation, Steel | Expressed in inches | Specified only if two elbow fittings are used to construct hose assembly.* |

- C = Stainless Steel
- B = Brass (91N)
- S = All Steel (91N)

OAL measured from centerline of fitting seat if elbow fittings are used.

Note: Face Seal type fittings are measured from sealing face.

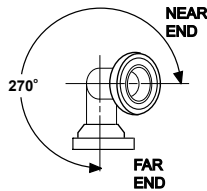

*Note:
*Starting with either end as the far end, measure the angle clockwise to describe the displacement of the near end.

Example: P9190639060606C-30-##

- P9190639060606C-30-##** – Permanent Crimp Hose Style
- P9190639060606C-30-##** – Hose Series
- P9190639060606C-30-##** – Fitting Configuration
 - 06 = Female SAE JIC 37° Swivel
 - 39 = Female SAE JIC 37° Swivel - 90° Elbow
- P9190639060606C-30-##** – Connection Size 1 -6 = 3/8"
- P9190639060606C-30-##** – Connection Size 2 -6 = 3/8"
- P9190639060606C-30-##** – Hose Size -6 = 3/8"
- P9190639060606C-30-##** – Fitting Material C= Stainless Steel
- P9190639060606C-30-##** – Overall Hose Length 30 inches
- P9190639060606C-30-##** – Displacement Angle Not used

Nomenclature - PTFE Hose

Series PAGE



| Size Code | Hose Code | Fitting Code | | | | | | |
|-----------|-----------|--------------|------|-------------------|---------------------------|----|-------------------------|----|
| 1/4" | 04 | hose | code | | | | | |
| 5/16" | 05 | CWV | V | Industrial Thread | Male Pipe NPTF Rigid | 03 | JIC Female Swivel | 30 |
| 3/8" | 06 | | | | Female Pipe NPTF Rigid | 06 | JIC Female Step Up | 32 |
| 1/2" | 08 | NCB | MB | | Male Pipe NPTF Step Down | 13 | Female ORFS Swivel | 80 |
| 5/8" | 10 | | | | Male Pipe NPTF Step Up | 23 | | |
| 3/4" | 12 | NCW | M | Flanges | Flange Retainer | 05 | | |
| 7/8" | 14 | | | | | | | |
| 1" | 16 | SCB | TB | Cam Lock | Female Cam & Groove | 07 | Male Cam & Groove | 08 |
| 1-1/4" | 20 | SCBV | JB | | | | | |
| 1-1/2" | 24 | | | Sanitary | Sanitary Tri Clamp Flange | 40 | Sanitary 3-Step Down | 4C |
| 2" | 32 | SCW | T | | Sanitary 1-Step Down | 4A | Sanitary Mini Flange | 42 |
| 2-1/2" | 40 | | | | Sanitary 2-Step Down | 4B | Sanitary Mini Step Up | 43 |
| 3" | 48 | SCWV | J | | | | | |
| 3-1/2" | 48 | | | Tube and Vacuum | Alok Male Standpipe | 38 | Female Alok Compression | 39 |
| 4" | 64 | STB | SB | | | | | |
| | | STW | S | | | | | |
| | | | | Special Ends | Cuffed Ends* | 90 | Non Standard Fitting | 4C |

*For use with CV01 and CVH convoluted assemblies

| Fitting Code | |
|------------------------|---|
| 304 Stainless (SS 304) | 4 |
| 316 Stainless (SS 316) | 6 |
| Steel | C |
| Hastelloy | H |
| Monel | M |

| Overall Length | |
|---------------------|--|
| Expressed In inches | |
| 0010 = 10 inches | |
| 0120 = 120 inches | |

| Flange Material | |
|-----------------|---|
| None | 0 |
| 316SS | 6 |

| Accessory Code | |
|------------------------|---|
| None | |
| Spring Guard | S |
| Fire Sleeve | F |
| FEP Heat Shrink | T |
| Polyolefin Heat Shrink | P |
| Vacuum Spring Wire | W |

Example: 32J03C13C0-0120-F

32J03C13C0-0120-F – Hose Size -32 = 2 inches
32J03C13C0-0120-F – Hose Code = SCWV Series
32J03C13C0-0120-F – Fitting Configuration End 1
 03 = Male Pipe NPTF Rigid
32J03C13C0-0120-F – Fitting Material End 1 C = Steel
32J03C13C0-0120-F – Fitting Configuration End 2
 13 = Male Pipe NPTF Step Down
32J03C13C0-0120-F – Fitting Material End 2 C = Steel
32J03C13C0-0120-F – Overall Hose Length 0120 = 120 inches
32J03C13C0-0120-F* – Accessory Code F - Fire Sleeve

*Note: There are places for 2 characters. If number, refer to length; if letter, refer to accessories code

Character 1 = Length in 1/8" increments
 Character 2 = Accessory code

The part numbering system shows the entire product line offered by the Parker PAGE International business unit. This catalog only displays a few common hoses.

D6R – Hybrid® SAE 100R17 Hydraulic Hose

Copolyester Core Tube

Compact hose construction for bend radius less than half of conventional SAE hoses.



Features

- Up to 40% lighter than comparable rubber hoses
- Wide range of fluid compatibility
- Bend radius less than half of conventional SAE 100R1AT and 100R2 hoses
- Low force to flex
- 3,000 psi constant working pressure

Construction

- Tube: Copolyester
- Reinforcement: One or two high tensile steel wire braids
- Cover: Smooth Synthetic Rubber

Operating Parameters

- Temperature Range:
 - Petroleum based hydraulic fluids and lubricating oils within a temperature range -40°F (-40°C) to 250°F (121°C)
 - Synthetic, synthetic blend, water, and water/oil emulsion hydraulic fluids limited to 185°F (85°C)
 - Water/glycol hydraulic fluids limited to 135°F (57°C)
- Vac. Rating: 28 inch Hg
- Change in length at Max. Working Pressure: +2% to -4%
- Min. Burst Pressure is 4x Max. Working Pressure at 73°F (23°C)

Compliance

- Exceeds SAE J517 100R17
- MSHA compliant cover

Fittings

- 56 Series – pg. E-33
- For most Parker products, Crimp Die Selection charts are found online at www.parker.com/crimpsource
- Access instructions are on pg. G-3

Notes

- Non-perforated cover

Color

- ● Black

Series D6R

[Visit the webpage](#)

| Part Number | Nominal I.D. | | Maximum O.D. | | Maximum Working Pressure | | Minimum Bend Radius | | Weight | | Permanent Fitting Series |
|-------------|--------------|------|--------------|------|--------------------------|------|---------------------|------|----------|--------|--------------------------|
| | inch | mm | inch | mm | psi | MPa | inch | mm | lbs./ft. | kg/mtr | |
| D6R04 | 1/4 | 6.3 | 0.46 | 11.7 | 3,045 | 21.0 | 1-1/2 | 38.1 | 0.10 | 0.14 | 56 |
| D6R05 | 5/16 | 8 | 0.52 | 13.2 | 3,045 | 21.0 | 1-3/4 | 44.5 | 0.12 | 0.18 | 56 |
| D6R06 | 3/8 | 10 | 0.61 | 15.5 | 3,045 | 21.0 | 2 | 50.8 | 0.17 | 0.25 | 56 |
| D6R08 | 1/2 | 12.5 | 0.78 | 19.9 | 3,045 | 21.0 | 3 | 76.2 | 0.26 | 0.38 | 56 |



WARNING

This product can expose you to chemicals including Antimony Oxide (Antimony Trioxide), which is known to the State of California to cause cancer, and 2-Imidazolidinethione, which is known to the State of California to cause birth defects or other reproductive harm. For more information go to www.P65Warnings.ca.gov

HFSR Hybrid® SAE 100R1AT Hydraulic Hose

Copolyester Core Tube

Compact O.D. without reduced flow and up to 40% lighter than comparable rubber hoses.



Features

- Up to 40% lighter than comparable rubber hoses
- Wide range of fluid compatibility
- Bend radius less than half of conventional SAE 100R1AT and 100R2 hoses
- Low force to flex

Compliance

- Meets/Exceeds SAE J517 100R1AT
- MSHA compliant cover

Construction

- Tube: Copolyester
- Reinforcement: High tensile steel wire braid
- Cover: Smooth Synthetic Rubber

Fittings

- 56 Series – pg. E-33
- For most Parker products, Crimp Die Selection charts are found online at www.parker.com/crimpsource
- Access instructions are on pg. G-3

Operating Parameters

- Temperature Range:
 - Petroleum based hydraulic fluids and lubricating oils within a temperature range -40°F (-40°C) to 250°F (121°C)
 - Synthetic, synthetic blend, water, and water/oil emulsion hydraulic fluids limited to 185°F (85°C)
 - Water/glycol hydraulic fluids limited to 135°F (57°C)
- Vac. Rating: 28 inch Hg
- Change in length at Max. Working Pressure: +2% to -4%
- Min. Burst Pressure is 4x Max. Working Pressure at 73°F (23°C)

Notes

- Non-perforated cover

Color

- ● Black

Series HFS2R

[Visit the webpage](#)

| Part Number | Nominal I.D. | | Maximum O.D. | | Maximum Working Pressure | | Minimum Bend Radius | | Weight | | Permanent Fitting Series |
|-------------|--------------|------|--------------|------|--------------------------|------|---------------------|-------|----------|--------|--------------------------|
| | inch | mm | inch | mm | psi | MPa | inch | mm | lbs./ft. | kg/mtr | |
| HFSR04 | 1/4 | 6.3 | 0.46 | 11.7 | 3,263 | 22.5 | 1-1/2 | 38.1 | 0.10 | 0.15 | 56 |
| HFSR05 | 5/16 | 8 | 0.52 | 13.2 | 3,118 | 21.5 | 1-3/4 | 44.5 | 0.12 | 0.18 | 56 |
| HFSR06 | 3/8 | 10 | 0.61 | 15.5 | 2,611 | 18.0 | 2 | 50.8 | 0.17 | 0.25 | 56 |
| HFSR08 | 1/2 | 12.5 | 0.74 | 18.8 | 2,500 | 17.2 | 3 | 76.2 | 0.21 | 0.31 | 56 |
| HFSR12 | 3/4 | 19 | 1.02 | 25.9 | 1,523 | 10.5 | 4-1/2 | 108.0 | 0.31 | 0.46 | 56 |
| HFSR16 | 1 | 25 | 1.31 | 33.2 | 1,276 | 8.8 | 7-1/2 | 190.5 | 0.44 | 0.66 | 56 |



WARNING

This product can expose you to chemicals including Antimony Oxide (Antimony Trioxide), which is known to the State of California to cause cancer, and 2-Imidazolidinethione, which is known to the State of California to cause birth defects or other reproductive harm. For more information go to www.P65Warnings.ca.gov

HFS2R - Hybrid® Hydraulic Hose

Copolyester Core Tube

Compact O.D. for easier change outs and up to 40% lighter than comparable rubber hose.



Features

- Up to 40% lighter than comparable rubber hoses
- Wide range of fluid compatibility
- Compact hose construction
- Bend radius less than half of conventional 100R2 hoses
- Low force to flex

Construction

- Tube: Copolyester
- Reinforcement: One or two high tensile steel wire braids
- Cover: Smooth Synthetic Rubber

Operating Parameters

- Temperature Range:
 - Petroleum based hydraulic fluids and lubricating oils within a temperature range -40°F (-40°C) to 212°F (100°C)
 - Synthetic, synthetic blend, water, and water/oil emulsion hydraulic fluids limited to 185°F (85°C)
 - Water/glycol hydraulic fluids limited to 135°F (57°C)
- Vac. Rating: 28 inch Hg
- Change in length at Max. Working Pressure: +2% to -4%
- Min. Burst Pressure is 4x Max. Working Pressure at 73°F (23°C)

Compliance

- MSHA compliant cover

Fittings

- 56 Series – pg. E-33
- For most Parker products, Crimp Die Selection charts are found online at www.parker.com/crimpsource
- Access instructions are on pg. G-3

Notes

- *Two wire braid
- Non-perforated cover

Color

- ● Black

Series HFS2R

[Visit the webpage](#)

| Part Number | Nominal I.D. | | Maximum O.D. | | Maximum Working Pressure | | Minimum Bend Radius | | Weight | | Permanent Fitting Series |
|-------------|--------------|------|--------------|------|--------------------------|------|---------------------|------|----------|--------|--------------------------|
| | inch | mm | inch | mm | psi | MPa | inch | mm | lbs./ft. | kg/mtr | |
| HFS2R04* | 1/4 | 6.3 | 0.54 | 13.7 | 5,076 | 35.0 | 2 | 50.0 | 0.20 | 0.29 | 56 |
| HFS2R06 | 3/8 | 10 | 0.64 | 16.3 | 4,061 | 28.0 | 2-1/2 | 63.5 | 0.20 | 0.30 | 56 |
| HFS2R08 | 1/2 | 12.5 | 0.78 | 19.9 | 3,553 | 24.5 | 3-1/2 | 88.9 | 0.26 | 0.38 | 56 |



WARNING

This product can expose you to chemicals including Antimony Oxide (Antimony Trioxide), which is known to the State of California to cause cancer, and 2-Imidazolidinethione, which is known to the State of California to cause birth defects or other reproductive harm. For more information go to www.P65Warnings.ca.gov

H6 - Low Temperature SAE 100R17 Hydraulic Hose

Copolyester Core Tube

Largest temperature range in a medium pressure hydraulic hose.



Features

- Largest temperature range in a medium pressure hydraulic hose
- Low length change under pressure
- Ideal for over-the-sheave boom applications

Compliance

- Meets/Exceeds SAE J517 100R17 performance

Construction

- Tube: Copolyester
- Reinforcement: One or two high tensile steel wire braids
- Cover: Abrasion resistant copolyester

Fittings

- 56 Series - pg. E-33 HY Series - Fittings available from Parker Hose Products Division
- For most Parker products, Crimp Die Selection charts are found online at www.parker.com/crimpsource
- Access instructions are on pg. G-3

Operating Parameters

- Temperature Range:
 - Petroleum based hydraulic fluids and lubricating oils within a temperature range:
 - H604 to H608 -70°F (-57°C) to 250°F (121°C)
 - H610 to H612 -50°F (-45°C) to 250°F (121°C)
 - Synthetic, synthetic blend, water, and water/oil emulsion hydraulic fluids limited to 135°F (57°C)
- Vac. Rating: 28 inch Hg
- Change in length at Max. Working Pressure: +2% to -4%
- Min. Burst Pressure is 4x Max. Working Pressure at 73°F (23°C)

Notes

- *Two wire braid
- Twin line hose available
- Preformed assemblies
- Non-perforated cover

Color

- ● Black

Series H6

[Visit the webpage](#)

| Part Number | Nominal I.D. | | Maximum O.D. | | Maximum Working Pressure | | Minimum Bend Radius | | Weight | | Permanent Fitting Series |
|-------------|--------------|------|--------------|------|--------------------------|------|---------------------|-------|----------|--------|--------------------------|
| | inch | mm | inch | mm | psi | MPa | inch | mm | lbs./ft. | kg/mtr | |
| H604 | 1/4 | 6.3 | 0.49 | 12.5 | 3,045 | 21.0 | 2 | 50.0 | 0.11 | 0.16 | 56 |
| H606 | 3/8 | 10 | 0.65 | 16.4 | 3,045 | 21.0 | 2-1/2 | 63.5 | 0.19 | 0.28 | 56 |
| H608 | 1/2 | 12.5 | 0.78 | 19.8 | 3,045 | 21.0 | 3-1/2 | 88.9 | 0.25 | 0.38 | 56 |
| H610* | 5/8 | 16 | 1.00 | 25.3 | 3,045 | 21.0 | 4 | 100.0 | 0.48 | 0.71 | HY |
| H612* | 3/4 | 19 | 1.17 | 29.6 | 3,045 | 21.0 | 4-3/4 | 120.0 | 0.67 | 1.00 | HY |



WARNING

This product can expose you to chemicals including Antimony Oxide (Antimony Trioxide), which is known to the State of California to cause cancer, and 2-Imidazolidinethione, which is known to the State of California to cause birth defects or other reproductive harm. For more information go to www.P65Warnings.ca.gov

R6 - Abrasion King, SAE 100R17 Hydraulic Hose

Copolyester Core Tube

Low temperature and abrasion resistant fabric cover.



Features

- Light weight
- Excellent flexibility
- Excellent abrasion resistance
- Blue plait provides hose identification

Compliance

- Meets/Exceeds SAE J517 100R17 performance

Construction

- Tube: Copolyester
- Reinforcement: One or two high tensile steel wire braids
- Cover: Abrasion-resistant Nylon Fabric

Fittings

- HY Series - Fittings available from Parker Hose Products Division
- For most Parker products, Crimp Die Selection charts are found online at www.parker.com/crimpsource
- Access instructions are on pg. G-3

Operating Parameters

- Temperature Range:
 - ♦ Petroleum based hydraulic fluids and lubricating oils within a temperature range:
 - R604 to R610 -70°F (-57°C) to 250°F (121°C)
 - R612 -50°F (-45°C) to 212°F (100°C)
 - ♦ Synthetic, synthetic blend, water, and water/oil emulsion hydraulic fluids limited to 135°F (57°C)
- Vac. Rating: 28 inch Hg
- Change in length at Max. Working Pressure: +2% to -4%
- Min. Burst Pressure is 4x Max. Working Pressure at 73°F (23°C)

Notes

- *Two wire braid
- Non-perforated cover

Color

- ● Black

Series R6

[Visit the webpage](#)

| Part Number | Nominal I.D. | | Maximum O.D. | | Maximum Working Pressure | | Minimum Bend Radius | | Weight | | Permanent Fitting Series |
|-------------|--------------|------|--------------|------|--------------------------|------|---------------------|-------|----------|--------|--------------------------|
| | inch | mm | inch | mm | psi | MPa | inch | mm | lbs./ft. | kg/mtr | |
| R604 | 1/4 | 6.3 | 0.53 | 13.5 | 3000 | 20.7 | 2 | 50.8 | 0.11 | 0.16 | HY |
| R606 | 3/8 | 10 | 0.69 | 17.5 | 3000 | 20.7 | 2-1/2 | 63.5 | 0.20 | 0.30 | HY |
| R608 | 1/2 | 12.5 | 0.84 | 21.3 | 3000 | 20.7 | 3-1/2 | 88.9 | 0.27 | 0.40 | HY |
| R610* | 5/8 | 16 | 1.09 | 27.7 | 3000 | 20.7 | 4 | 102.0 | 0.51 | 0.76 | HY |
| R612* | 3/4 | 19 | 1.24 | 31.5 | 3000 | 20.7 | 4-3/4 | 120.7 | 0.71 | 1.06 | HY |



WARNING

This product can expose you to chemicals including Antimony Oxide (Antimony Trioxide), which is known to the State of California to cause cancer, and 2-Imidazolidinethione, which is known to the State of California to cause birth defects or other reproductive harm. For more information go to www.P65Warnings.ca.gov

HTBR – Eliminator® Hybrid® Hydraulic Hose

Copolyester Core Tube

Four-spiral wire hose performance in a high tensile two-wire braid construction.



Features

- Four-spiral wire hose performance in a high tensile two-wire construction
- Ideal for applications typically reserved for spiral wire reinforced hoses
- Excellent flexibility
- Compact design

Construction

- Tube: Copolyester
- Reinforcement: Two high tensile steel wire braids
- Cover: Smooth Synthetic Rubber

Operating Parameters

- Temperature Range:
 - Petroleum based hydraulic fluids and lubricating oils within a temperature range -40°F (-40°C) to 212°F (100°C)
 - Synthetic, synthetic blend, water, and water/oil emulsion hydraulic fluids limited to 185°F (85°C) **HTB04 is limited to 135°F (57°C)
 - Water/glycol hydraulic fluids limited to 135°F (57°C)
- Vac. Rating: 28 inch Hg
- Change in length at Max. Working Pressure: +2% to -4%
- Min. Burst Pressure is 4x Max. Working Pressure at 73°F (23°C)

Compliance

- MSHA compliant cover

Fittings

- HY Series 43 Series - Fittings available from Parker Hose Products Division
- For most Parker products, Crimp Die Selection charts are found online at www.parker.com/crimpsource
- Access instructions are on pg. G-3

Notes

- Non-perforated cover

Color

- ● Black

Series HTBR

[Visit the webpage](#)

| Part Number | Nominal I.D. | | Maximum O.D. | | Maximum Working Pressure | | Minimum Bend Radius | | Weight | | Permanent Fitting Series |
|-------------|--------------|------|--------------|------|--------------------------|------|---------------------|-------|----------|--------|--------------------------|
| | inch | mm | inch | mm | psi | MPa | inch | mm | lbs./ft. | kg/mtr | |
| HTBR06 | 3/8 | 10 | 0.72 | 18.2 | 5,500 | 37.9 | 6 | 152.4 | 0.33 | 0.50 | 43 |
| HTBR08 | 1/2 | 12.5 | 0.85 | 21.5 | 5,000 | 34.4 | 7 | 177.8 | 0.43 | 0.63 | 43 |
| HTBR10 | 5/8 | 16 | 1.01 | 25.6 | 4,000 | 27.5 | 8 | 203.2 | 0.52 | 0.77 | 43 |
| HTBR12 | 3/4 | 19 | 1.17 | 29.6 | 4,000 | 27.5 | 9-1/2 | 241.3 | 0.72 | 1.07 | 43 |
| HTBR16 | 1 | 25 | 1.45 | 36.8 | 3,500 | 24.1 | 12 | 304.8 | 0.91 | 1.36 | 43 |



WARNING

This product can expose you to chemicals including Antimony Oxide (Antimony Trioxide), which is known to the State of California to cause cancer, and 2-Imidazolidinethione, which is known to the State of California to cause birth defects or other reproductive harm. For more information go to www.P65Warnings.ca.gov

560TJ - TOUGHJACKET™ SAE 100R1AT Hydraulic Hose

Copolyester Core Tube

Twin or multi-line available.
General hydraulic hose.



Features

- Twin or multi-line available.
- Lighter and smaller than 100R1AT with longer lengths
- Fast response hose
- TOUGHJACKET Polyurethane cover for best abrasion resistance
- Low length change under pressure makes it an ideal solution for boom or cable track applications where long lengths are required
- Twin or multi-line hose/hose assembly production capabilities

Construction

- Tube: Copolyester
- Reinforcement: High Tensile Steel Wire Braid
- Cover: TOUGHJACKET Polyurethane

Operating Parameters

- Temperature Range:
 - Petroleum based hydraulic fluids and lubricating oils within a temperature range -40°F (-40°C) to 250°F (121°C)
 - Synthetic, synthetic blend, water, and water/oil emulsion hydraulic fluids limited to 185°F (85°C)
 - Water/glycol hydraulic fluids limited to 135°F (57°C)
- Vac. Rating: 28 inch Hg
- Change in length at Max. Working Pressure: +/-2%
- Min. Burst Pressure is 4x Max. Working Pressure at 73°F (23°C)

Compliance

- Meets/Exceeds SAE J517 100R1AT performance
- MSHA compliant cover

Fittings

- 56 Series – pg. E-33
- For most Parker products, Crimp Die Selection charts are found online at www.parker.com/crimpsource
- Access instructions are on pg. G-3

Notes

- Non-perforated cover

Color

- ● Black



[Visit the webpage](#)

Series 560TJ

| Part Number | Nominal I.D. | | Maximum O.D. | | Maximum Working Pressure | | Minimum Bend Radius | | Weight | | Permanent Fitting Series |
|-------------|--------------|------|--------------|------|--------------------------|------|---------------------|-------|----------|--------|--------------------------|
| | inch | mm | inch | mm | psi | MPa | inch | mm | lbs./ft. | kg/mtr | |
| 560TJ-3 | 3/16 | 5 | 0.39 | 9.9 | 3,626 | 25.0 | 3/4 | 19.1 | 0.01 | 0.11 | 56 |
| 560TJ-4 | 1/4 | 6.3 | 0.47 | 11.9 | 3,263 | 22.5 | 1-1/2 | 38.1 | 0.09 | 0.14 | 56 |
| 560TJ-5 | 5/16 | 8 | 0.53 | 13.4 | 3,118 | 21.5 | 1-3/4 | 44.5 | 0.11 | 0.16 | 56 |
| 560TJ-6 | 3/8 | 10 | 0.61 | 15.5 | 2,750 | 19.0 | 2 | 50.8 | 0.14 | 0.21 | 56 |
| 560TJ-8 | 1/2 | 12.5 | 0.75 | 19.0 | 2,500 | 17.2 | 3 | 76.2 | 0.19 | 0.29 | 56 |
| 560TJ-10 | 5/8 | 16 | 0.93 | 23.6 | 2,000 | 13.8 | 4 | 101.6 | 0.31 | 0.47 | 56 |
| 560TJ-12 | 3/4 | 19 | 1.04 | 26.4 | 1,750 | 12.1 | 4-1/4 | 107.9 | 0.28 | 0.42 | 56 |

WARNING

This product can expose you to chemicals including Antimony Oxide (Antimony Trioxide), which is known to the State of California to cause cancer, and 2-Imidazolidinethione, which is known to the State of California to cause birth defects or other reproductive harm. For more information go to www.P65Warnings.ca.gov

563TJ – TOUGHJACKET™ SAE 100R17 Hydraulic Hose

Copolyester Core Tube - 3,000 psi

Lowest length change under pressure (+/- 1%).



Features

- Low length change under pressure makes it an ideal solution for boom or cable track applications where long lengths are required
- Up to 5% smaller O.D. than comparable 100R17 hoses
- Up to 42% lighter than comparable 100R17 hoses
- Excellent flexibility
- Consistent long-lengths
- TOUGHJACKET Polyurethane cover for best abrasion resistance
- Twin or multi-line hose/hose assembly production capabilities

Construction

- Tube: Copolyester
- Reinforcement: One or two high tensile steel wire braids
- Cover: TOUGHJACKET Polyurethane

Operating Parameters

- Temperature Range:
 - Petroleum based hydraulic fluids and lubricating oils within a temperature range -40°F (-40°C) to 250°F (121°C)
 - Synthetic, synthetic blend, water, and water/oil emulsion hydraulic fluids limited to 185°F (85°C)
 - Water/glycol hydraulic fluids limited to 135°F (57°C)
- Vac. Rating: 28 inch Hg
- Change in length at Max. Working Pressure:
 - 4 to -8: +/- 1%
 - 10 to -16: +/- 2%
- Min. Burst Pressure is 4x Max. Working Pressure at 73°F (23°C)

Compliance

- Meets/Exceeds SAE J517 100R17 performance
- MSHA compliant cover

Fittings

- 56 Series – pg. E-33 43 Series - Fittings available from Parker Hose Products Division
- For most Parker products, Crimp Die Selection charts are found online at www.parker.com/crimpsource
- Access instructions are on pg. G-3

Notes

- Non-Perforated Cover
- For a lower temperature working hose -70°F (-57°C), see 563LT
- *Two wire braid

Color

- ● Black



Series 563TJ

[Visit the webpage](#)

| Part Number | Nominal I.D. | | Maximum O.D. | | Maximum Working Pressure | | Minimum Bend Radius | | Weight | | Permanent Fitting Series |
|-------------|--------------|------|--------------|------|--------------------------|------|---------------------|-------|----------|--------|--------------------------|
| | inch | mm | inch | mm | psi | MPa | inch | mm | lbs./ft. | kg/mtr | |
| 563TJ-4 | 1/4 | 6.3 | 0.47 | 11.9 | 3,045 | 21.0 | 1-1/2 | 38.1 | 0.09 | 0.14 | 56 |
| 563TJ-6 | 3/8 | 10 | 0.64 | 16.3 | 3,045 | 21.0 | 2 | 50.8 | 0.19 | 0.29 | 56 |
| 563TJ-8 | 1/2 | 12.5 | 0.77 | 19.5 | 3,045 | 21.0 | 2-3/4 | 69.9 | 0.24 | 0.36 | 56 |
| 563TJ-10* | 5/8 | 16 | 0.97 | 24.6 | 3,045 | 21.0 | 3-1/2 | 88.9 | 0.40 | 0.60 | 43 |
| 563TJ-12* | 3/4 | 19 | 1.12 | 28.3 | 3,045 | 21.0 | 4-1/4 | 108.0 | 0.55 | 0.82 | 43 |
| 563TJ-16* | 1 | 25 | 1.45 | 36.9 | 3,045 | 21.0 | 6 | 150.0 | 0.88 | 1.31 | 43 |

WARNING

This product can expose you to chemicals including Antimony Oxide (Antimony Trioxide), which is known to the State of California to cause cancer, and 2-Imidazolidinethione, which is known to the State of California to cause birth defects or other reproductive harm. For more information go to www.P65Warnings.ca.gov

563LT – SAE 100R17 Low Temperature Hydraulic Hose

Copolyester Core Tube

Largest temperature range in a medium pressure hydraulic hose.



Features

- Lowest length change under pressure
- 3,000 psi constant pressure
- Ideal for over-the-sheave applications in cold temperature applications
- Twin or multi-line hose/hose assembly production capabilities

Construction

- Tube: Copolyester
- Reinforcement: High Tensile Steel Wire Braid
- Cover: Copolyester

Operating Parameters

- Temperature Range:
 - Petroleum based hydraulic fluids and lubricating oils within a temperature range:
 - 563LT-4 to 563LT-8 -70°F (-57°C) to 250°F (121°C)
 - 563LT-10 to 563LT-12 -50°F (-45°C) to 250°F (121°C)
 - Synthetic, synthetic blend, water, and water/oil emulsion hydraulic fluids limited to 185°F (85°C)
 - Water/glycol hydraulic fluids limited to 135°F (57°C)
- Vac. Rating: 28 inch Hg
- Change in length at Max. Working Pressure:
 - 4 to 8: +/-1%
 - 10 to 12: +/-2%
- Min. Burst Pressure is 4x Max. Working Pressure at 73°F (23°C)

Compliance

- Meets/Exceeds SAE 100R17 performance

Fittings

- 56 Series – pg. E-33 43 Series - Fittings available from Parker Hose Products Division
- For most Parker products, Crimp Die Selection charts are found online at www.parker.com/crimpsource
- Access instructions are on pg. G-3

Notes

- *Two-wire braid
- Non-perforated cover

Color

- ● Black



Series 563LT

[Visit the webpage](#)

| Part Number | Nominal I.D. | | Maximum O.D. | | Maximum Working Pressure | | Minimum Bend Radius | | Weight | | Permanent Fitting Series |
|-------------|--------------|------|--------------|------|--------------------------|------|---------------------|------|----------|--------|--------------------------|
| | inch | mm | inch | mm | psi | MPa | inch | mm | lbs./ft. | kg/mtr | |
| 563LT-4 | 1/4 | 6.3 | 0.47 | 11.9 | 3,045 | 21.0 | 1-1/2 | 38.1 | 0.09 | 0.13 | 56 |
| 563LT-6 | 3/8 | 10 | 0.64 | 16.3 | 3,045 | 21.0 | 2 | 50.8 | 0.19 | 0.29 | 56 |
| 563LT-8 | 1/2 | 12.5 | 0.77 | 19.5 | 3,045 | 21.0 | 2-3/4 | 69.9 | 0.24 | 0.36 | 56 |
| 563LT-10* | 5/8 | 16 | 0.97 | 24.6 | 3,045 | 21.0 | 3-1/2 | 88.9 | 0.40 | 0.60 | 43 |
| 563LT-12* | 3/4 | 19 | 1.12 | 28.3 | 3,045 | 21.0 | 4-1/4 | 108 | 0.55 | 0.82 | 43 |



WARNING

This product can expose you to chemicals including Antimony Oxide (Antimony Trioxide), which is known to the State of California to cause cancer, and 2-Imidazolidinethione, which is known to the State of California to cause birth defects or other reproductive harm. For more information go to www.P65Warnings.ca.gov

590TJ – TOUGHJACKET™ Hydraulic Hose

Copolyester Core Tube

Two-wire strength, one wire construction for improved bend radius.



Features

- Two wire strength, one wire construction, improved bend radius results
- Low length change under pressure makes it an ideal solution for boom or cable track applications where long lengths are required
- Twin and multi-line available
- TOUGHJACKET Polyurethane cover for best abrasion resistance
- Twin or multi-line hose/hose assembly production capabilities

Construction

- Tube: Copolyester
- Reinforcement: One or two high tensile steel wire braids
- Cover: TOUGHJACKET Polyurethane

Operating Parameters

- Temperature Range:
 - Petroleum based hydraulic fluids and lubricating oils within a temperature range -40°F (-40°C) to 250°F (121°C)
 - Synthetic, synthetic blend, water, and water/oil emulsion hydraulic fluids limited to 185°F (85°C)
 - Water/glycol hydraulic fluids limited to 135°F (57°C)
- Vac. Rating: 28 inch Hg
- Change in length at Max. Working Pressure: +/-2%
- Min. Burst Pressure is 4x Max. Working Pressure at 73°F (23°C)

Compliance

- MSHA compliant cover

Fittings

- 56 Series – pg. E-33 43 Series - Fittings available from Parker Hose Products Division
- For most Parker products, Crimp Die Selection charts are found online at www.parker.com/crimpsource
- Access instructions are on pg. G-3

Notes

- Non-perforated cover
- *Two wire braid

Color

- ● Black



Series 590TJ

[Visit the webpage](#)

| Part Number | Nominal I.D. | | Maximum O.D. | | Maximum Working Pressure | | Minimum Bend Radius | | Weight | | Permanent Fitting Series |
|-------------|--------------|------|--------------|------|--------------------------|------|---------------------|-------|----------|--------|--------------------------|
| | inch | mm | inch | mm | psi | MPa | inch | mm | lbs./ft. | kg/mtr | |
| 590TJ-4 | 1/4 | 6.3 | 0.49 | 12.5 | 5,076 | 35.0 | 1-3/4 | 44.5 | 0.13 | 0.20 | 56 |
| 590TJ-6 | 3/8 | 10 | 0.64 | 16.3 | 4,061 | 28.0 | 2-1/4 | 57.2 | 0.19 | 0.29 | 56 |
| 590TJ-8 | 1/2 | 12.5 | 0.77 | 19.5 | 3,553 | 24.5 | 3-1/4 | 82.6 | 0.24 | 0.36 | 56 |
| 590TJ-12 | 3/4 | 19 | 1.08 | 27.3 | 2,500 | 17.2 | 4-3/4 | 120.0 | 0.39 | 0.58 | 43 |
| 590TJ-16* | 1 | 25 | 1.42 | 36.0 | 2,030 | 14.0 | 6 | 150.0 | 0.71 | 1.06 | 43 |

WARNING

This product can expose you to chemicals including Antimony Oxide (Antimony Trioxide), which is known to the State of California to cause cancer, and 2-Imidazolidinethione, which is known to the State of California to cause birth defects or other reproductive harm. For more information go to www.P65Warnings.ca.gov

594TJ - TOUGHJACKET™ SAE 100R19 Hydraulic Hose

Copolyester Core Tube - 4,000 psi

Four-spiral wire performance
in a two-wire braid construction.



Features

- Four-spiral wire hose performance in a high tensile two-wire braid construction
- Excellent flexibility
- Consistent long-lengths
- TOUGHJACKET Polyurethane cover for best abrasion resistance
- Twin or multi-line hose/hose assembly production capabilities

Construction

- Tube: Copolyester
- Reinforcement: One or two high tensile steel wire braids
- Cover: TOUGHJACKET Polyurethane™

Operating Parameters

- Temperature Range:
 - Petroleum based hydraulic fluids and lubricating oils within a temperature range -40°F (-40°C) to 212°F (100°C)
 - Synthetic, synthetic blend, water, and water/oil emulsion hydraulic fluids limited to 185°F (85°C); **594TJ-10 is limited to 135°F (57°C)
 - Water/glycol hydraulic fluids limited to 135°F (57°C)
- Vac. Rating: 28 inch Hg
- Change in length at Max. Working Pressure:
 - 4 to -10: +/- 2%
 - 12: +2% to -4%
- Min. Burst Pressure is 4x Max. Working Pressure at 73°F (23°C)

Compliance

- Meets/Exceeds SAE 100R19 performance
- MSHA compliant cover

Fittings

- 56 Series - pg. E-33 43 Series - Fittings available from Parker Hose Products Division
- For most Parker products, Crimp Die Selection charts are found online at www.parker.com/crimpsource
- Access instructions are on pg. G-3

Notes

- Non-perforated cover
- *Two wire braid

Color

- ● Black



[Visit the webpage](#)

Series 594TJ

| Part Number | Nominal I.D. | | Maximum O.D. | | Maximum Working Pressure | | Minimum Bend Radius | | Weight | | Permanent Fitting Series |
|--------------|--------------|------|--------------|------|--------------------------|------|---------------------|-------|----------|--------|--------------------------|
| | inch | mm | inch | mm | psi | MPa | inch | mm | lbs./ft. | kg/mtr | |
| 594TJ-4 | 1/4 | 6.3 | 0.49 | 12.5 | 4,061 | 28.0 | 1-3/4 | 44.5 | 0.13 | 0.19 | 56 |
| 594TJ-6 | 3/8 | 10 | 0.64 | 16.3 | 4,061 | 28.0 | 2-1/2 | 63.5 | 0.19 | 0.28 | 56 |
| 594TJ-8* | 1/2 | 12.5 | 0.85 | 21.5 | 4,061 | 28.0 | 3-1/2 | 88.9 | 0.39 | 0.59 | 43 |
| 594TJ-10* ** | 5/8 | 16 | 1.04 | 26.4 | 4,061 | 28.0 | 4 | 100.0 | 0.59 | 0.88 | 43 |
| 594TJ-12* | 3/4 | 19 | 1.17 | 29.7 | 4,061 | 28.0 | 4-3/4 | 120.0 | 0.72 | 1.07 | 43 |

WARNING

This product can expose you to chemicals including Antimony Oxide (Antimony Trioxide), which is known to the State of California to cause cancer, and 2-Imidazolidinethione, which is known to the State of California to cause birth defects or other reproductive harm. For more information go to www.P65Warnings.ca.gov

510C – SAE 100R7 Hydraulic Hose

Copolyester Core Tube

Largest size range for a medium pressure hydraulic hose.



Features

- Excellent abrasion resistance
- Excellent flexibility
- Low coefficient of friction cover
- Medium pressure service for permanent and field attachable fittings

Construction

- Tube: Copolyester
- Reinforcement: Fiber
- Cover: Polyurethane

Operating Parameters

- Temperature Range:
 - Petroleum based hydraulic fluids and lubricating oils within a temperature range -40°F (-40°C) to 212°F (100°C)
 - Synthetic, synthetic blend, water, and water/oil emulsion hydraulic fluids limited to 135°F (57°C)
- Vac. Rating: 28 inch Hg
- Change in length at Max. Working Pressure: +/-2%
- Min. Burst Pressure is 4x Max. Working Pressure at 73°F (23°C)

Compliance

- Meets/Exceeds SAE J517 100R7 (excluding -2)
- MSHA compliant cover (excluding -4)
- DNV-GL Type Approved

Fittings

- 56 Series – pg. E-33 51 Series – pg. E-22
- For most Parker products, Crimp Die Selection charts are found online at www.parker.com/crimpsource
- Access instructions are on pg. G-3

Notes

- Perforated cover
- *3/16" and 1/4" working pressure reduced to 3,000 and 2,750 psi respectively when using field attachable fittings
- Field attachable fittings are not intended for use on hose that has been previously in service

Color

- Black

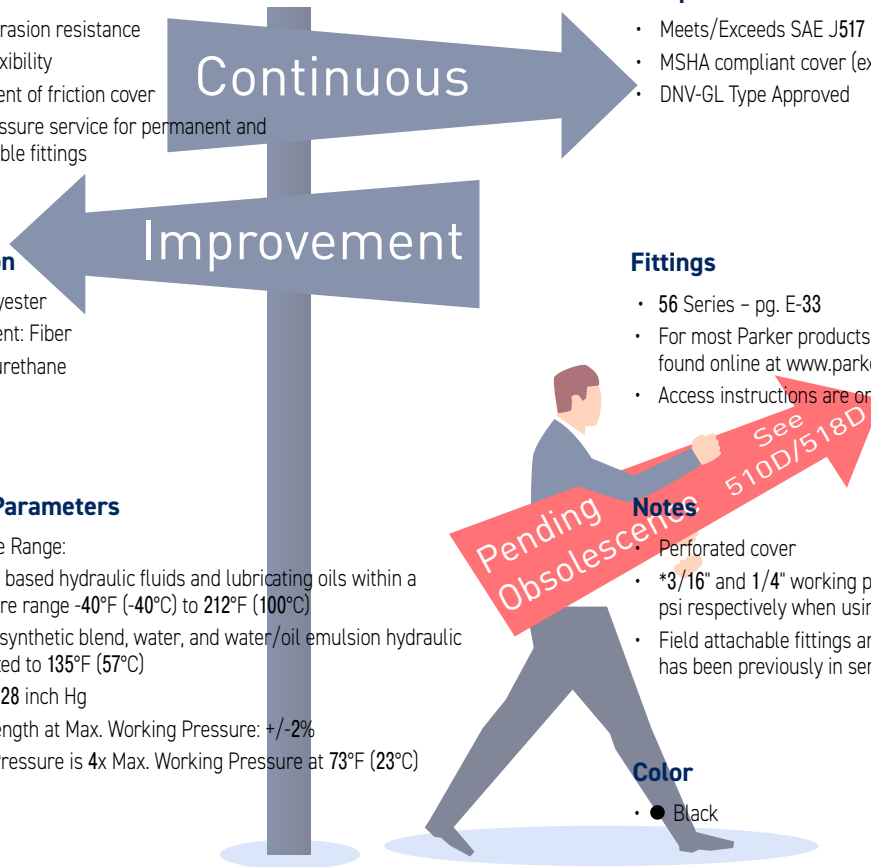

Series 510C

[Visit the webpage](#)

| Part Number | Nominal I.D. | | Maximum O.D. | | Maximum Working Pressure | | Minimum Bend Radius | | Weight | | Permanent Fitting Series | F.A. Fitting Series |
|-------------|--------------|------|--------------|------|--------------------------|------|---------------------|-------|----------|--------|--------------------------|---------------------|
| | inch | mm | inch | mm | psi | MPa | inch | mm | lbs./ft. | kg/mtr | | |
| 510C-2 | 1/8 | 3.2 | 0.34 | 8.6 | 2,500 | 17.2 | 1/2 | 13.0 | 0.03 | 0.05 | 56 | – |
| 510C-3 | 3/16 | 5 | 0.43 | 10.9 | 3,250 | 22.4 | 3/4 | 19.0 | 0.05 | 0.07 | 56 | 51* |
| 510C-4 | 1/4 | 6.3 | 0.47 | 11.9 | 3,000 | 20.7 | 1-1/2 | 38.0 | 0.05 | 0.08 | 56 | 51* |
| 510C-5 | 5/16 | 8 | 0.57 | 14.5 | 2,500 | 17.2 | 1-3/4 | 44.0 | 0.08 | 0.11 | 56 | 51 |
| 510C-6 | 3/8 | 10 | 0.64 | 16.3 | 2,250 | 15.5 | 2 | 51.0 | 0.10 | 0.14 | 56 | 51 |
| 510C-8 | 1/2 | 12.5 | 0.81 | 20.6 | 2,250 | 15.5 | 3 | 76.0 | 0.15 | 0.22 | 56 | 51 |
| 510C-12 | 3/4 | 19 | 1.09 | 27.7 | 1,250 | 8.7 | 5 | 127.0 | 0.21 | 0.31 | 56 | 51 |
| 510C-16 | 1 | 25 | 1.32 | 33.5 | 1,000 | 6.9 | 8 | 203.0 | 0.27 | 0.40 | 56 | 51 |

WARNING

This product can expose you to chemicals including Nickel compounds, which is known to the State of California to cause cancer, and Toluene, which is known to the State of California to cause birth defects or other reproductive harm. For more information go to www.P65Warnings.ca.gov.

510D - SAE 100R7 Hydraulic Hose

Nylon Core Tube

Largest size selection
in a 100R7 hose.



Features

- Matte cover for low coefficient of friction
- Special order colors
- Twin or multi-line available
- Good chemical compatibility
- Approved for use with 51R-Series Field Attachable and Rapid Assembly connections

Construction

- Tube: Nylon: -3 to -12
Copolyester: -16
- Reinforcement: Fiber
- Cover: Polyurethane

Operating Parameters

- Temperature Range:
-40°F (-40°C) to 212°F (100°C)
 - Synthetic, synthetic blend, water, and water/oil emulsion hydraulic fluids limited to 135°F (57°C) {510D-16 only}
- Vac. Rating: 28 inch Hg
- Change in length at Max. Working Pressure: +/-2%
- Min. Burst Pressure is 4x Max. Working Pressure at 73°F (23°C)

Compliance

- Meets/Exceeds SAE J517 100R7
- MSHA compliant cover
- DNV-GL Type Approved
- ISO 3949-R7-1

Fittings

- 56 Series - pg. E-33 51R Series - pg. E-24
- For most Parker products, Crimp Die Selection charts are found online at www.parker.com/crimpsource
- Access instructions are on pg. G-3

Notes

- Perforated cover
- For -2 hose needs, please reference HLBD02 on pg. A-62
- Field attachable fittings are not intended for use on hose that has been previously in service

Color

- ● Black

Series 510D

[Visit the webpage](#)

| Part Number | Nominal I.D. | | Maximum O.D. | | Maximum Working Pressure | | Minimum Bend Radius | | Weight | | Permanent Fitting Series | F.A. Fitting Series |
|-------------|--------------|------|--------------|------|--------------------------|------|---------------------|-------|----------|--------|--------------------------|---------------------|
| | inch | mm | inch | mm | psi | MPa | inch | mm | lbs./ft. | kg/mtr | | |
| 510D-3 | 3/16 | 5 | 0.43 | 10.9 | 3,250 | 22.4 | 3/4 | 19.0 | 0.05 | 0.07 | 56 | 51R |
| 510D-4 | 1/4 | 6.3 | 0.47 | 11.9 | 3,000 | 21.0 | 1-1/2 | 38.0 | 0.06 | 0.09 | 56 | 51R |
| 510D-5 | 5/16 | 8 | 0.57 | 14.5 | 2,500 | 17.5 | 1-3/4 | 44.0 | 0.08 | 0.11 | 56 | - |
| 510D-6 | 3/8 | 10 | 0.64 | 16.3 | 2,250 | 15.8 | 2 | 51.0 | 0.10 | 0.14 | 56 | 51R |
| 510D-8 | 1/2 | 12.5 | 0.81 | 20.6 | 2,250 | 15.8 | 3 | 76.0 | 0.15 | 0.22 | 56 | 51R |
| 510D-10 | 5/8 | 16 | 0.98 | 24.9 | 2,250 | 15.8 | 4 | 102.0 | 0.21 | 0.31 | 56 | - |
| 510D-12 | 3/4 | 19 | 1.05 | 26.7 | 1,250 | 8.8 | 5 | 127.0 | 0.17 | 0.25 | 56 | - |
| 510D-16 | 1 | 25 | 1.32 | 33.5 | 1,000 | 7.0 | 8 | 203.0 | 0.27 | 0.40 | 56 | - |



WARNING

This product can expose you to chemicals including Nickel compounds, which is known to the State of California to cause cancer, and Toluene, which is known to the State of California to cause birth defects or other reproductive harm. For more information go to www.P65Warnings.ca.gov.

518C – SAE 100R7 Non-conductive Hose

Copolyester Core Tube

Hydraulic service where hydraulic circuit exposure and contact with high voltage may be encountered.



Features

- Twin or multi-line constructions available
- High density braid for maximum impulse life without loss of flexibility
- Low coefficient of friction cover

Construction

- Tube: Copolyester
- Reinforcement: Fiber
- Cover: Polyurethane

Operating Parameters

- Temperature Range:
 - Petroleum based hydraulic fluids and lubricating oils within a temperature range -40°F (-40°C) to 212°F (100°C)
 - Synthetic, synthetic blend, water, and water/oil emulsion hydraulic fluids limited to 135°F (57°C)
- Vac. Rating: 28 inch Hg
- Change in length at Max. Working Pressure: +/-2%
- Min. Burst Pressure: (SAE requires 4:1 Design Factor)
 - 4:1 design factor required per SAE J517 100R7
 - 3:1 min design factor acceptable per ANSI A92.2

Compliance

- Meets SAE J517 for less than 50 micro-amps leakage under 75,000 volts per ft.
- Meets/Exceeds SAE J517 100R7 specifications and Electrical Standards except 518C-2 with respect to maximum working pressure
- DNV-GL Type Approved
- ANSI A92.2

Fittings

- 56 Series – pg. E-33 51 Series – pg. E-22
- For most Parker products, Crimp Die Selection charts are found online at www.parker.com/crimpsource
- Access instructions are on pg. G-3

Notes

- Non-perforated cover
- Lay lines on this hose will have both ANSI and SAE maximum working pressure listed. ANSI A92.2 "Vehicle Mounted Elevating and Rotating Aerial Devices"
- *3/16" and 1/4" working pressure reduced to 3,000 and 2,750 psi respectively when using field attachable fittings
- Field attachable fittings are not intended for use on hose that has been previously in service

Color

- Orange (non-conductive)

Series 518C

[Visit the webpage](#)

| Part Number | Nominal I.D. | | Maximum O.D. | | ANSI A92.2 Maximum Working Pressure | | SAE 100R7 Maximum Working Pressure | | Minimum Bend Radius | | Weight | | Permanent Fitting Series | F.A. Fitting Series |
|-------------|--------------|------|--------------|------|-------------------------------------|------|------------------------------------|------|---------------------|-------|----------|--------|--------------------------|---------------------|
| | inch | mm | inch | mm | psi | MPa | psi | MPa | inch | mm | lbs./ft. | kg/mtr | | |
| 518C-2 | 1/8 | 3.2 | 0.34 | 8.6 | 3,150 | 21.7 | 2,500 | 17.2 | 1/2 | 13.0 | 0.03 | 0.05 | 56 | – |
| 518C-3 | 3/16 | 5 | 0.43 | 10.9 | 3,250 | 22.4 | 3,250 | 22.4 | 3/4 | 19.0 | 0.05 | 0.07 | 56 | 51* |
| 518C-4 | 1/4 | 6.3 | 0.47 | 11.9 | 3,150 | 21.7 | 3,000 | 21.0 | 1-1/2 | 38.0 | 0.05 | 0.08 | 56 | 51* |
| 518C-5 | 5/16 | 8 | 0.57 | 14.5 | 3,150 | 21.7 | 2,500 | 17.2 | 1-3/4 | 44.0 | 0.08 | 0.11 | 56 | 51 |
| 518C-6 | 3/8 | 10 | 0.64 | 16.3 | 3,000 | 20.7 | 2,250 | 15.5 | 2 | 51.0 | 0.10 | 0.14 | 56 | 51 |
| 518C-8 | 1/2 | 12.5 | 0.81 | 20.6 | 3,000 | 20.7 | 2,250 | 15.5 | 3 | 76.0 | 0.15 | 0.22 | 56 | 51 |
| 518C-12 | 3/4 | 19 | 1.09 | 27.7 | 1,660 | 11.4 | 1,250 | 8.7 | 5 | 127.0 | 0.21 | 0.31 | 56 | 51 |
| 518C-16 | 1 | 25 | 1.32 | 33.5 | 1,330 | 9.2 | 1,000 | 6.9 | 8 | 203.0 | 0.27 | 0.40 | 56 | 51 |

WARNING

This product can expose you to chemicals including Nickel compounds, which is known to the State of California to cause cancer, and Toluene, which is known to the State of California to cause birth defects or other reproductive harm. For more information go to www.P65Warnings.ca.gov.

518D – SAE 100R7 Non-conductive Hose

Nylon Core Tube

Nylon core for maximum resistance in hydraulic circuit applications where contact with high voltage may be encountered.



Features

- Nylon core for maximum resistance to permeable fluids
- -4 construction features:
 - Super high density braid resulting in compact braid O.D.
 - Heavier polyurethane jacket improving abrasion resistance and multi/twin-line separation for bonded assemblies
- Low coefficient of friction cover
- Twin or multi-line constructions available
- Approved for use with 51R-Series Field Attachable and Rapid Assembly connections

Construction

- Tube: Nylon: -2 to -12 Copolyester: -16
- Reinforcement: Fiber
- Cover: Polyurethane

Operating Parameters

- Temperature Range: -40°F (-40°C) to 212°F (100°C)
- {518D-16 only}
 - Petroleum based hydraulic fluids and lubricating oils within a temperature range -70°F (-57°C) to 212°F (100°C)
 - Synthetic, synthetic blend, water, and water/oil emulsion hydraulic fluids limited to 135°F (57°C)
- Vac. Rating: 28 inch Hg
- Change in length at Max. Working Pressure: +/-2%
- Min. Burst Pressure: (SAE requires 4:1 Design Factor)
 - 4:1 design factor required per SAE J517 100R7
 - 3:1 min design factor acceptable per ANSI A92.2

Compliance

- Meets SAE J517 electrical standards (non-conductivity)
- Meets/Exceeds SAE J517 100R7
- DNV-GL Type Approved
- ANSI A92.2
- ISO 3949-R7-2

Fittings

- 56 Series – pg. E-33 51R Series – pg. E-24
- For most Parker products, Crimp Die Selection charts are found online at www.parker.com/crimpsource
- Access instructions are on pg. G-3

Notes

- Non-perforated cover
- Lay lines on this hose will have both ANSI and SAE maximum working pressure listed. ANSI A92.2 "Vehicle Mounted Elevating and Rotating Aerial Devices"
- Field attachable fittings are not intended for use on hose that has been previously in service

Color

- ● Orange (non-conductive)

Series 518D

[Visit the webpage](#)

| Part Number | Nominal I.D. | | Maximum O.D. | | ANSI A92.2 Maximum Working Pressure | | SAE 100R7 Maximum Working Pressure | | Minimum Bend Radius | | Weight | | Permanent Fitting Series | F.A. Fitting Series |
|-------------|--------------|------|--------------|------|-------------------------------------|------|------------------------------------|------|---------------------|-------|----------|--------|--------------------------|---------------------|
| | inch | mm | inch | mm | psi | MPa | psi | MPa | inch | mm | lbs./ft. | kg/mtr | | |
| 518D-2 | 1/8 | 3.2 | 0.34 | 8.6 | 3,150 | 21.7 | 3,000 | 21.0 | 1/2 | 13.0 | 0.03 | 0.05 | 56 | - |
| 518D-3 | 3/16 | 5 | 0.43 | 10.9 | 3,250 | 22.4 | 3,250 | 22.4 | 3/4 | 19.0 | 0.05 | 0.07 | 56 | 51R |
| 518D-4 | 1/4 | 6.3 | 0.47 | 11.9 | 3,150 | 21.7 | 3,000 | 21.0 | 1-1/2 | 38.0 | 0.06 | 0.09 | 56 | 51R |
| 518D-5 | 5/16 | 8 | 0.57 | 14.5 | 3,150 | 21.7 | 2,500 | 17.5 | 1-3/4 | 44.0 | 0.08 | 0.11 | 56 | - |
| 518D-6 | 3/8 | 10 | 0.64 | 16.3 | 3,000 | 21.0 | 2,250 | 15.8 | 2 | 51.0 | 0.10 | 0.14 | 56 | 51R |
| 518D-8 | 1/2 | 12.5 | 0.81 | 20.6 | 3,000 | 21.0 | 2,250 | 15.8 | 3 | 76.0 | 0.15 | 0.22 | 56 | 51R |
| 518D-10 | 5/8 | 16 | 0.98 | 24.9 | 3,000 | 21.0 | 2,250 | 15.8 | 4 | 102.0 | 0.21 | 0.31 | 56 | - |
| 518D-12 | 3/4 | 19 | 1.05 | 26.7 | 1,660 | 11.4 | 1,250 | 8.8 | 5 | 127.0 | 0.17 | 0.25 | 56 | - |
| 518D-16 | 1 | 25 | 1.32 | 33.5 | 1,330 | 9.2 | 1,000 | 7.0 | 8 | 203.0 | 0.27 | 0.40 | 56 | - |

WARNING

This product can expose you to chemicals including Nickel compounds, which is known to the State of California to cause cancer, and Toluene, which is known to the State of California to cause birth defects or other reproductive harm. For more information go to www.P65Warnings.ca.gov.

520N/528N – SAE 100R8 Hydraulic Hose

Nylon Core Tube

Fast response with high density braid;
available in twin-line constructions.



Features

- Twin and multi-line available
- Fast response, lighter and smaller O.D. than 100R2 hose

Construction

- Tube: Nylon
- Reinforcement: Aramid Fiber
- Cover: Polyurethane

Operating Parameters

- Temperature Range:
-40°F (-40°C) to 212°F (100°C)
- Vac. Rating: 28 inch Hg
- Change in length at Max. Working Pressure: +/-2%
- Min. Burst Pressure is 4x Max. Working Pressure at 73°F (23°C)

Compliance

- Meets/Exceeds SAE J517 100R8
- Meets SAE J517 electrical standards (non-conductivity) - 528N
- MSHA compliant cover - 520N
- DNV-GL Type Approved

Fittings

- 56 Series – pg. E-33
- For most Parker products, Crimp Die Selection charts are found online at www.parker.com/crimpsource
- Access instructions are on pg. G-3

Notes

- Perforated cover - 520N
- Non-perforated cover - 528N

Color

- ● Black - 520N
- ● Orange (non-conductive) - 528N

Series 520N/528N

[Visit the webpage](#)

| Part Number | | Nominal I.D. | | Maximum O.D. | | Maximum Working Pressure | | Minimum Bend Radius | | Weight | | Permanent Fitting Series |
|----------------|--------|--------------|------|--------------|------|--------------------------|------|---------------------|-------|----------|--------|--------------------------|
| Non-Conductive | | inch | mm | inch | mm | psi | MPa | inch | mm | lbs./ft. | kg/mtr | |
| 520N-3 | 528N-3 | 3/16 | 5 | 0.43 | 10.9 | 5,000 | 34.5 | 1-1/2 | 38.0 | 0.05 | 0.07 | 56 |
| 520N-4 | 528N-4 | 1/4 | 6.3 | 0.51 | 13.0 | 5,000 | 34.5 | 2 | 51.0 | 0.07 | 0.10 | 56 |
| 520N-5 | 528N-5 | 5/16 | 8 | 0.57 | 14.5 | 4,500 | 31.0 | 2-1/2 | 64.0 | 0.08 | 0.12 | 56 |
| 520N-6 | 528N-6 | 3/8 | 10 | 0.65 | 16.5 | 4,000 | 27.6 | 2-1/2 | 64.0 | 0.08 | 0.13 | 56 |
| 520N-8 | 528N-8 | 1/2 | 12.5 | 0.81 | 20.6 | 3,500 | 24.1 | 4 | 102.0 | 0.14 | 0.20 | 56 |



WARNING

This product can expose you to chemicals including Nickel compounds, which is known to the State of California to cause cancer, and Toluene, which is known to the State of California to cause birth defects or other reproductive harm. For more information go to www.P65Warnings.ca.gov.

527BA- Breathing Air Refill Hose

Nylon Core Tube

7,000 psi constant pressure.



Features

- 7,000 psi constant pressure hose

Compliance

- CGA G7.1-1 Grade E Breathing Air Standards
- NFPA 1901

Construction

- Tube: Nylon
- Reinforcement: Aramid Fiber
- Cover: Polyurethane

Fittings

- CG Series – pg. E-72

| | | | |
|-----------|-----------|-----------|-----------|
| 101CG-2-X | 102CG-4-X | 137CG-4-X | 141CG-4-X |
| 101CG-4-X | 103CG-4-X | 139CG-4-X | 1L9CG-4-X |
| 102CG-2-X | 106CG-4-X | 13ECG-4-X | |
- Approved configurations referenced above
- When used with 527BA hose only, Parflex -4 JIC and -4 O-ring boss fittings are rated for 7000 psi (48.3 MPa) working pressure
- Please note X in the part number references the qualified hose sizes above but does not indicate availability
- For most Parker products, Crimp Die Selection charts can be found online at www.parker.com/crimpsource
- Access instructions are on pg. G-3

Operating Parameters

- Temperature Range:
 - 40°F (-40°C) to 180°F (82°C)
- Vac. Rating: 28 inch Hg
- Change in length at Max. Working Pressure: +/-2%
- Min. Burst Pressure is 4x Max. Working Pressure at 73°F (23°C)

Notes

- Perforated cover
- Not for use as part of a SCBA systems
- This hose is not for use between a pressure reducing regulator and breathing mask
- For fitting attachment lubricate only with water or non-toxic lubricant. Do not assemble with petroleum or hydrocarbon based lubricants. Do not flush with solvents of any kind
- This hose does not contain a conductive element; therefore, it should not be used with explosive gases such as pure oxygen and hydrogen
- Hose is compliant with CGA Grade E Breathing Air Standards, however air quality is dependent upon all system components

Color

- ● Blue

Series 527BA

[Visit the webpage](#)

| Part Number | Nominal I.D. | | Maximum O.D. | | Maximum Working Pressure | | Minimum Bend Radius | | Weight | | Permanent Fitting Series |
|-------------|--------------|-----|--------------|------|--------------------------|------|---------------------|------|----------|--------|--------------------------|
| | inch | mm | inch | mm | psi | MPa | inch | mm | lbs./ft. | kg/mtr | |
| 527BA-3 | 3/16 | 5 | 0.43 | 10.9 | 7,000 | 48.3 | 1-1/2 | 38.0 | 0.05 | 0.07 | CG |
| 527BA-4 | 1/4 | 6.3 | 0.52 | 13.2 | 7,000 | 48.3 | 2 | 51.0 | 0.07 | 0.11 | CG |

WARNING

This product can expose you to chemicals including Nickel compounds, which is known to the State of California to cause cancer, and Toluene, which is known to the State of California to cause birth defects or other reproductive harm. For more information go to www.P65Warnings.ca.gov.

540N – SAE 100R7 - Hydraulic Hose

Nylon Core Tube

Hose
A

Low coefficient of friction jacket.



Tubing
Thermoplastic
B

Features

- Low coefficient of friction jacket
- Special order colors
- Twin or multi-line available
- Good chemical compatibility

Construction

- Tube: Nylon
- Reinforcement: Fiber
- Cover: Polyurethane

Operating Parameters

- Temperature Range:
-40°F (-40°C) to 212°F (100°C)
- Vac. Rating: 28 inch Hg
- Change in length at Max. Working Pressure: +/-2%
- Min. Burst Pressure is 4x Max. Working Pressure at 73°F (23°C)

Compliance

- Meets/Exceeds SAE J517 100R7
- MSHA compliant cover
- DNV-GL Type Approved

Fittings

- 56 Series – pg. E-33
- For most Parker products, Crimp Die Selection charts are found online at www.parker.com/crimpsource
- Access instructions are on pg. G-3

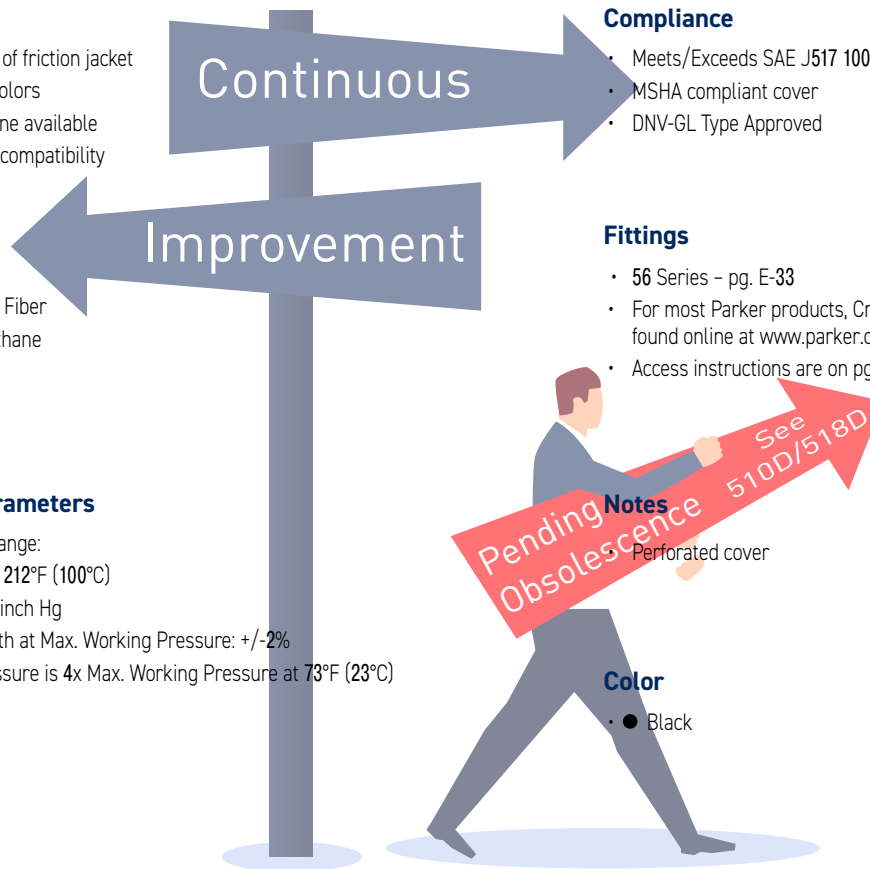

Coiled Air Hose
& Fittings
C

Transportation
D

Fittings
E

Series 540N

[Visit the webpage](#)

| Part Number | Nominal I.D. | | Maximum O.D. | | Maximum Working Pressure | | Minimum Bend Radius | | Weight | | Permanent Fitting Series |
|-------------|--------------|------|--------------|------|--------------------------|------|---------------------|-------|----------|--------|--------------------------|
| | inch | mm | inch | mm | psi | MPa | inch | mm | lbs./ft. | kg/mtr | |
| 540N-2 | 1/8 | 3.2 | 0.34 | 8.6 | 3,000 | 20.7 | 1/2 | 13.0 | 0.03 | 0.05 | 56 |
| 540N-3 | 3/16 | 5 | 0.44 | 10.9 | 3,000 | 20.7 | 3/4 | 19.0 | 0.04 | 0.06 | 56 |
| 540N-4 | 1/4 | 6.3 | 0.50 | 12.7 | 2,750 | 19.0 | 1-1/2 | 38.0 | 0.07 | 0.10 | 56 |
| 540N-5 | 5/16 | 8 | 0.58 | 14.7 | 2,500 | 17.2 | 1-3/4 | 44.0 | 0.07 | 0.10 | 56 |
| 540N-6 | 3/8 | 10 | 0.65 | 16.5 | 2,250 | 15.5 | 2 | 51.0 | 0.09 | 0.13 | 56 |
| 540N-8 | 1/2 | 12.5 | 0.81 | 20.6 | 2,000 | 13.8 | 3 | 76.0 | 0.13 | 0.19 | 56 |
| 540N-12 | 3/4 | 19 | 1.05 | 26.7 | 1,250 | 8.6 | 6 | 152.0 | 0.17 | 0.25 | 56 |

Tooling, Equipment
& Accessories
F



WARNING

This product can expose you to chemicals including Nickel compounds, which is known to the State of California to cause cancer, and Toluene, which is known to the State of California to cause birth defects or other reproductive harm. For more information go to www.P65Warnings.ca.gov.

General Technical
G

540P – SAE 100R7 Specialty Water Hose

Polyethylene Core Tube

Non leaching core tube.



Features

- Plasticizer free non-leaching core tube
- Low-moisture permeability
- Ideal for potable water, distilled water and de-ionized water

Compliance

- Meets/Exceeds SAE J517 100R7
- FDA, CFR21 Part 177 compliant core

Construction

- Tube: Polyethylene
- Reinforcement: Fiber
- Cover: Polyurethane

Fittings

- 56 Series – pg. E-33
- For most Parker products, Crimp Die Selection charts are found online at www.parker.com/crimpsource
- Access instructions are on pg. G-3

Operating Parameters

- Temperature Range: -40°F (-40°C) to 150°F (66°C)
- Vac. Rating: 28 inch Hg
- Change in length at Max. Working Pressure: +/-2%
- Min. Burst Pressure is 4x Max. Working Pressure at 73°F (23°C)

Notes

- Perforated cover

Color

- Aqua

Series 540P

[Visit the webpage](#)

| Part Number | Nominal I.D. | | Maximum O.D. | | Maximum Working Pressure | | Minimum Bend Radius | | Weight | | Permanent Fitting Series |
|-------------|--------------|------|--------------|------|--------------------------|------|---------------------|------|----------|--------|--------------------------|
| | inch | mm | inch | mm | psi | MPa | inch | mm | lbs./ft. | kg/mtr | |
| 540P-4 | 1/4 | 6.4 | .50 | 12.7 | 2,750 | 19.0 | 1-1/4 | 32.0 | .05 | .08 | 56 |
| 540P-6 | 3/8 | 9.5 | .65 | 16.5 | 2,250 | 15.5 | 2 | 51.0 | .09 | .13 | 56 |
| 540P-8 | 1/2 | 12.7 | .81 | 20.6 | 2,000 | 13.8 | 3 | 76.0 | .13 | .19 | 56 |

WARNING

This product can expose you to chemicals including Nickel compounds, which is known to the State of California to cause cancer, and Toluene, which is known to the State of California to cause birth defects or other reproductive harm. For more information go to www.P65Warnings.ca.gov.

53DM/538DM – DuraMax™ SAE 100R18 Low Temperature Hydraulic Hose

Nylon/Copolyester Core Tube

Superior flexibility in cold temperature applications.



Features

- Low coefficient of friction cover
- Superior flexibility in cold temperature applications
- Excellent for over-the-sheave applications
- Better bend radius than SAE J517 and 100R7
- 3,045 psi constant pressure

Construction

- Tube: Nylon: -2
Copolyester: -4 to -12
- Reinforcement: Fiber
- Cover: Copolyester

Operating Parameters

- Temperature Range:
 - Petroleum based hydraulic fluids and lubricating oils within a temperature range -70°F (-57°C) to 212°F (100°C)
 - Synthetic, synthetic blend, water, and water/oil emulsion hydraulic fluids limited to 135°F (57°C) {Sizes -4 thru -12}
- Vac. Rating: 28 inch Hg
- Change in length at Max. Working Pressure: +/-2%
- Min. Burst Pressure is 4x Max. Working Pressure at 73°F (23°C)

Compliance

- Meets/Exceeds SAE J517 100R18
- Meets SAE J517 electrical standards (non-conductivity) - 538DM

Fittings

- 56 Series – pg. E-33 CG Series – pg. E-72
CY Series – pg. E-77
- For most Parker products, Crimp Die Selection charts are found online at www.parker.com/crimpsource
- Access instructions are on pg. G-3

Notes

- Perforated cover - 53DM
- Non-perforated cover - 538DM

Color

- ● Black - 53DM
- ● Orange (non-conductive) - 538DM



Series 53DM/538DM

[Visit the webpage](#)

| Part Number | Nominal I.D. | Maximum O.D. | | Maximum Working Pressure | | Minimum Bend Radius | | Weight | | Permanent Fitting Series | | |
|-------------|--------------|--------------|------|--------------------------|------|---------------------|----|----------|--------|--------------------------|------|----|
| | | inch | mm | psi | MPa | inch | mm | lbs./ft. | kg/mtr | | | |
| 53DM-2 | - | 1/8 | 3.2 | 0.33 | 8.2 | 3,045 | 21 | 1/2 | 13 | 0.03 | 0.05 | CY |
| 53DM-4 | - | 1/4 | 6.3 | 0.49 | 11.9 | 3,045 | 21 | 1-1/4 | 32 | 0.07 | 0.10 | 56 |
| 53DM-6 | 538DM-6 | 3/8 | 10 | 0.66 | 16.7 | 3,045 | 21 | 2 | 51 | 0.11 | 0.16 | 56 |
| 53DM-8 | - | 1/2 | 12.5 | 0.84 | 21.3 | 3,045 | 21 | 3-1/2 | 89 | 0.17 | 0.26 | 56 |
| 53DM-10 | - | 5/8 | 16 | 1.03 | 26.2 | 3,045 | 21 | 4 | 102 | 0.22 | 0.33 | 56 |
| 53DM-12 | - | 3/4 | 19 | 1.13 | 28.7 | 3,045 | 21 | 6-1/2 | 165 | 0.26 | 0.39 | CG |

WARNING

This product can expose you to chemicals including N-Methylpyrrolidone, which is known to the State of California to cause cancer. For more information go to www.P65Warnings.ca.gov.

55LT – SAE 100R7 Low Temperature Hydraulic Hose

Nylon Core Tube

Superior flexibility in cold temperature applications.



Features

- Twin and multi-line available
- Superior flexibility in cold temperature applications
- Excellent for over-the-sheave applications

Compliance

- Meets/Exceeds SAE J517 100R7

Construction

- Tube: Nylon
- Reinforcement: Fiber
- Cover: Copolyester

Fittings

- 56 Series – pg. E-33
- For most Parker products, Crimp Die Selection charts are found online at www.parker.com/crimpsource
- Access instructions are on pg. G-3

Operating Parameters

- Temperature Range: -70°F (-57°C) to 212°F (100°C)
- Vac. Rating: 28 inch Hg
- Change in length at Max. Working Pressure: +/-2%
- Min. Burst Pressure is 4x Max. Working Pressure at 73°F (23°C)

Notes

- Perforated cover

Color

- ● Black



Series 55LT

[Visit the webpage](#)

| Part Number | Nominal I.D. | | Maximum O.D. | | Maximum Working Pressure | | Minimum Bend Radius | | Weight | | Permanent Fitting Series |
|-------------|--------------|------|--------------|------|--------------------------|------|---------------------|------|----------|--------|--------------------------|
| | inch | mm | inch | mm | psi | MPa | inch | mm | lbs./ft. | kg/mtr | |
| 55LT-3 | 3/16 | 5 | 0.43 | 10.9 | 3,250 | 22.4 | 3/4 | 19.0 | 0.05 | 0.08 | 56 |
| 55LT-4 | 1/4 | 6.3 | 0.51 | 13.0 | 3,000 | 20.7 | 1-1/4 | 32.0 | 0.07 | 0.10 | 56 |
| 55LT-5 | 5/16 | 8 | 0.57 | 14.5 | 2,500 | 17.2 | 1-3/4 | 44.0 | 0.09 | 0.13 | 56 |
| 55LT-6 | 3/8 | 10 | 0.65 | 16.5 | 2,250 | 15.5 | 2 | 51.0 | 0.10 | 0.14 | 56 |
| 55LT-8 | 1/2 | 12.5 | 0.81 | 20.6 | 2,000 | 13.8 | 3 | 76.0 | 0.14 | 0.21 | 56 |

WARNING

This product can expose you to chemicals including Nickel compounds, which is known to the State of California to cause cancer, and Toluene, which is known to the State of California to cause birth defects or other reproductive harm. For more information go to www.P65Warnings.ca.gov.

56DH - Diagnostic Hose

Nylon Core Tube

Improved signal response due to smaller I.D. and low volumetric expansion.



Features

- Improved signal response due to smaller I.D. and low volumetric expansion
- Excellent flexibility
- Ease of routing due to flexibility and small O.D.
- Light weight - up to 70% less than other diagnostic hoses
- Twin and multi-line constructions available

Construction

- Tube: Nylon
- Reinforcement: Aramid Fiber
- Cover: Polyurethane

Operating Parameters

- Temperature Range: -40°F (-40°C) to 200°F (93°C)
- Vac. Rating: 28 inch Hg
- Change in length at Max. Working Pressure: +/-2%
- Min. Burst Pressure is 4x Max. Working Pressure at 73°F (23°C)

Compliance

- MSHA compliant cover

Fittings

- CY Series - pg. E-77 SF Series - pg. E-81
- For most Parker products, Crimp Die Selection charts are found online at www.parker.com/crimpsource
- Access instructions are on pg. G-3

Notes

- Perforated cover

Color

- ● Black

Series 56DH

[Visit the webpage](#)

| Part Number | Nominal I.D. | | Maximum O.D. | | Maximum Working Pressure | | Minimum Bend Radius | | Weight | | Permanent Fitting Series |
|-------------|--------------|-----|--------------|-----|--------------------------|------|---------------------|------|----------|--------|--------------------------|
| | inch | mm | inch | mm | psi | MPa | inch | mm | lbs./ft. | kg/mtr | |
| 56DH-1.5 | 0.09 | 2.3 | 0.21 | 5.3 | 6,000 | 41.4 | 1/4 | 6.4 | 0.01 | 0.02 | SF |
| 56DH-2 | 0.14 | 3.6 | 0.32 | 8.1 | 6,000 | 41.4 | 1/2 | 13.0 | 0.03 | 0.05 | CY |



WARNING

This product can expose you to chemicals including Nickel compounds, which is known to the State of California to cause cancer, and Toluene, which is known to the State of California to cause birth defects or other reproductive harm. For more information go to www.P65Warnings.ca.gov.

575X/575XN/578X - Fast Response Hose

Nylon Core Tube

5,000 psi constant pressure
and long, continuous lengths.



Features

- Light weight
- Low change in length under pressure
- Low volumetric expansion
- Fast response even over longer lengths
- 5000 psi constant pressure

Construction

- Tube: Nylon
- Reinforcement: Aramid Fiber
- Cover: Polyurethane (575X)
Polyurethane TOUGHJACKET (578X-4, -6)
Nylon (575XN)
Elastomeric Nylon (578X-12)

Operating Parameters

- Temperature Range:
575X-3 to 575X-16, 575XN-8 -40°F (-40°C) to 212°F (100°C)
575XN-16 -40°F (-40°C) to 150°F (65°C)
- Vac. Rating: 28 inch Hg
- Change in length at Max. Working Pressure: +/-2%
- Min. Burst Pressure is 4x Max. Working Pressure at 73°F (23°C)

Compliance

- MSHA compliant cover -575X/575XN-16 only
- DNV-GL Type Approved - 575X/575XN
- Meets SAE J517 electrical standards (non-conductivity) - 578X only

Fittings

- CG Series – pg. E-72
- For most Parker products, Crimp Die Selection charts are found online at www.parker.com/crimpsource
- Access instructions are on pg. G-3

Notes

- Non-perforated cover
- 575XN and 578X-12 are not available in twin-line or multi-line constructions

Color

- ● Black - 575X/575XN
- ● Orange (non-conductive) - 578X

Series 575X/575XN

[Visit the webpage](#)

| Part Number | Nominal I.D. | | Maximum O.D. | | Maximum Working Pressure | | Minimum Bend Radius | | Weight | | Permanent Fitting Series |
|-------------|--------------|------|--------------|------|--------------------------|------|---------------------|-------|----------|--------|--------------------------|
| | inch | mm | inch | mm | psi | MPa | inch | mm | lbs./ft. | kg/mtr | |
| 575X-3 | 3/16 | 5 | 0.43 | 10.9 | 5,000 | 34.5 | 1-1/2 | 38.0 | 0.05 | 0.07 | CG |
| 575X-4 | 1/4 | 6.3 | 0.51 | 13.0 | 5,000 | 34.5 | 2 | 51.0 | 0.07 | 0.10 | CG |
| 575X-6 | 3/8 | 10 | 0.64 | 16.3 | 5,000 | 34.5 | 3 | 76.0 | 0.09 | 0.13 | CG |
| 575XN-8 | 1/2 | 12.5 | 0.81 | 20.6 | 5,000 | 34.5 | 4 | 102.0 | 0.14 | 0.21 | CG |
| 575X-12 | 3/4 | 19 | 1.15 | 29.2 | 5,000 | 34.5 | 8 | 203.0 | 0.24 | 0.36 | CG |
| 575X-16 | 1 | 25 | 1.59 | 40.4 | 5,000 | 34.5 | 10 | 254.0 | 0.48 | 0.71 | CG |
| 575XN-16 | 1 | 25 | 1.51 | 38.3 | 5,000 | 34.5 | 10 | 254.0 | 0.37 | 0.55 | CG |

Series 578X

| Part Number | Nominal I.D. | | Maximum O.D. | | Maximum Working Pressure | | Minimum Bend Radius | | Weight | | Permanent Fitting Series |
|-------------|--------------|-----|--------------|------|--------------------------|------|---------------------|-------|----------|--------|--------------------------|
| | inch | mm | inch | mm | psi | MPa | inch | mm | lbs./ft. | kg/mtr | |
| 578X-4 | 1/4 | 6.3 | 0.51 | 13.0 | 5,000 | 34.5 | 2 | 51.0 | 0.07 | 0.10 | CG |
| 578X-6 | 3/8 | 10 | 0.64 | 16.3 | 5,000 | 34.5 | 3 | 76.0 | 0.09 | 0.13 | CG |
| 578X-12 | 3/4 | 19 | 1.17 | 29.6 | 5,000 | 34.5 | 8 | 203.0 | 0.26 | 0.39 | CG |

WARNING

This product can expose you to chemicals including Nickel compounds, which is known to the State of California to cause cancer, and Toluene, which is known to the State of California to cause birth defects or other reproductive harm. For more information go to www.P65Warnings.ca.gov.

580N/588N – SAE 100R8 High Pressure Hydraulic Hose

Nylon Core Tube

Lighter weight and smaller O.D. than comparable hoses with same working pressure.



Features

- Twin and multi-line available
- Lighter weight and smaller O.D. than 100R2

Construction

- Tube: Nylon
- Reinforcement: Fiber
- Cover: Polyurethane

Operating Parameters

- Temperature Range: -40°F (-40°C) to 212°F (100°C)
- Vac. Rating: 28 inch Hg
- Change in length at Max. Working Pressure: +/-2%
- Min. Burst Pressure is 4x Max. Working Pressure at 73°F (23°C)

Compliance

- Meets/Exceeds SAE J517 100R8
- Meets SAE J517 electrical standards (non-conductivity) - 588N
- MSHA compliant cover - 580N
- DNV-GL Type Approved

Fittings

- 56 Series – pg. E-33
- For most Parker products, Crimp Die Selection charts are found online at www.parker.com/crimpsource
- Access instructions are on pg. G-3

Notes

- Perforated cover - 580N
- *Non-perforated cover - 588N

Color

- ● Black - 580N
- ● Orange (non-conductive) - 588N

Series 580N/588N

[Visit the webpage](#)

| Part Number | | Nominal I.D. | | Maximum O.D. | | Maximum Working Pressure | | Minimum Bend Radius | | Weight | | Permanent Fitting Series |
|----------------|----------|--------------|------|--------------|------|--------------------------|------|---------------------|-------|----------|--------|--------------------------|
| Non-Conductive | | inch | mm | inch | mm | psi | MPa | inch | mm | lbs./ft. | kg/mtr | |
| 580N-8 | 588N-8* | 1/2 | 12.5 | 0.89 | 22.6 | 3,500 | 24.1 | 4 | 102.0 | 0.21 | 0.31 | 56 |
| 580N-10 | 588N-10* | 5/8 | 16 | 0.98 | 24.9 | 2,750 | 19.0 | 6 | 152.0 | 0.21 | 0.31 | 56 |
| 580N-12 | 588N-12* | 3/4 | 19 | 1.15 | 29.2 | 2,250 | 15.5 | 8 | 203.0 | 0.23 | 0.35 | 56 |
| 580N-16 | 588N-16* | 1 | 25 | 1.47 | 37.3 | 2,000 | 13.8 | 10 | 254.0 | 0.38 | 0.56 | 56 |



WARNING

This product can expose you to chemicals including Nickel compounds, which is known to the State of California to cause cancer, and Toluene, which is known to the State of California to cause birth defects or other reproductive harm. For more information go to www.P65Warnings.ca.gov.

83FR – DuraGard™ General Purpose Polyurethane Polyurethane Core Tube

Weld spatter resistant.



Features

- Weld spatter resistant
- Excellent abrasion resistance
- Excellent flexibility
- Compact bend radius
- Specially Formulated Polyurethane tube
- Twin-line or multi-line constructions available

Construction

- Tube: Specially Formulated Polyurethane
- Reinforcement: Fiber
- Cover: Polyurethane

Operating Parameters

- Temperature Range: -20°F (-29°C) to 200°F (93°C)
- Vac. Rating: 28 inch Hg
- Change in length at Max. Working Pressure: +/-2%
- Min. Burst Pressure is 4x Max. Working Pressure at 73°F (23°C)

Compliance

- Meets SAE J517 electrical standards (non-conductivity)
- UL94HB compliant
- MSHA compliant cover

Fittings

- 56 Series – pg. E-33 82 Series – Available from Parker Hose Products Division
- For most Parker products, Crimp Die Selection charts can be found online at www.parker.com/crimpsource
- Access instructions are on pg. G-3

Notes

- *Temperature and pressure reduced with 82 series Push-Lok Fitting: -20°F (-29°C) to 145°F (62°C) 175 psi maximum working pressure
- Non-perforated cover

Color

- ● Black (BLK)
- ● Blue (BLU)
- ● Brown (BRN)
- ● Green (GRN)
- ● Gray (GRA)
- ● Red (RED)

Series 83FR

[Visit the webpage](#)

| Part Number | Nominal I.D. | | Maximum O.D. | | Maximum Working Pressure | | Minimum Bend Radius | | Weight | | Permanent Fitting Series | Push-Lok Fitting* |
|-------------|--------------|------|--------------|------|--------------------------|-----|---------------------|------|----------|--------|--------------------------|-------------------|
| | inch | mm | inch | mm | psi | MPa | inch | mm | lbs./ft. | kg/mtr | | |
| 83FR-4 | 1/4 | 6.3 | 0.48 | 12.2 | 300 | 2.1 | 1 | 25.0 | 0.05 | 0.07 | 56 | 82* |
| 83FR-6 | 3/8 | 10 | 0.60 | 15.2 | 300 | 2.1 | 2 | 51.0 | 0.08 | 0.11 | 56 | 82* |
| 83FR-8 | 1/2 | 12.5 | 0.76 | 19.3 | 300 | 2.1 | 2-1/2 | 64.0 | 0.12 | 0.17 | 56 | 82* |
| 83FR-12 | 3/4 | 19 | 1.04 | 26.4 | 300 | 2.1 | 3-1/2 | 89.0 | 0.19 | 0.28 | 56 | 82* |



WARNING

This product can expose you to chemicals including N-Methylpyrrolidone, which is known to the State of California to cause cancer. For more information go to www.P65Warnings.ca.gov.

1035HT - High Temperature Power Cleaning Nylon Core Tube

Handles temperatures
up to 230°F (110°C).



Features

- Non-marring
- Broad temperature range

Construction

- Tube: Nylon
- Reinforcement: Fiber
- Cover: Polyurethane

Operating Parameters

- Temperature Range:
-40°F (-40°C) to 230°F (110°C)
- Vac. Rating: 28 inch Hg
- Change in length at Max. Working Pressure: +/-2%
- Min. Burst Pressure is 4x Max. Working Pressure at 73°F (23°C)

Fittings

- 56 Series - pg. E-33
- For most Parker products, Crimp Die Selection charts are found online at www.parker.com/crimpsource
- Access instructions are on pg. G-3

Notes

- Perforated cover
- Chlorinated solvents should not be used
- Also available with a blue jacket (1035HT-4-BLU) upon request
- HBR (Hose Bend Restrictor) suggested for carpet cleaning applications - See Hose Guard in Tooling Equipment and Accessories Section pg. F-18

Color

- ● Yellow

Series 1035HT

[Visit the webpage](#)

| Part Number | Nominal I.D. | | Maximum O.D. | | Maximum Working Pressure | | Minimum Bend Radius | | Weight | | Permanent Fitting Series |
|-------------|--------------|-----|--------------|------|--------------------------|------|---------------------|------|----------|--------|--------------------------|
| | inch | mm | inch | mm | psi | MPa | inch | mm | lbs./ft. | kg/mtr | |
| 1035HT-4 | 1/4 | 6.3 | 0.50 | 12.7 | 1,750 | 12.1 | 1-1/2 | 38.0 | 0.06 | 0.08 | 56 |

WARNING

This product can expose you to chemicals including Nickel compounds, which is known to the State of California to cause cancer, and Toluene, which is known to the State of California to cause birth defects or other reproductive harm. For more information go to www.P65Warnings.ca.gov.

B9 – General Purpose Transfer Hose

Polyurethane Core Tube

Specially formulated polyurethane for increased chemical resistance.



Features

- Excellent flexibility
- Light weight
- Specially Formulated Polyurethane core tube for good chemical compatibility

Construction

- Tube: Specially Formulated Polyurethane
- Reinforcement: Fiber
- Cover: Specially Formulated Polyurethane

Operating Parameters

- Temperature Range:
 - 40°F (-40°C) to 200°F (93°C)
 - Water/glycol hydraulic fluids limited to 130°F (54°C)
- Vac. Rating: 28 inch Hg
- Change in length at Max. Working Pressure: +/-2%
- Min. Burst Pressure is 4x Max. Working Pressure at 73°F (23°C)

Fittings

- 56 Series – pg. E-33 82 Series - Fittings available from Parker Hose Products Division
- For most Parker products, Crimp Die Selection charts can be found online at www.parker.com/crimpsource
- Access instructions are on pg. G-3

Notes

- *Temperature and pressure reduced with 82 series Push-Lok Fitting: -20°F (-29°C) to 100°F (38°C) 100 psi maximum working pressure
- Non-perforated cover

Color

- ● Red
- ● Black (BK) - B904BK

Series B9

[Visit the webpage](#)

| Part Number | Nominal I.D. | | Maximum O.D. | | Maximum Working Pressure | | Minimum Bend Radius | | Weight | | Permanent Fitting Series | Push-Lok Fitting* |
|-------------|--------------|------|--------------|------|--------------------------|-----|---------------------|-------|----------|--------|--------------------------|-------------------|
| | inch | mm | inch | mm | psi | MPa | inch | mm | lbs./ft. | kg/mtr | | |
| B903 | 3/16 | 5 | 0.39 | 9.9 | 250 | 1.7 | 1 | 25.0 | 0.04 | 0.06 | 56 | – |
| B904 | 1/4 | 6.3 | 0.46 | 11.7 | 250 | 1.7 | 1-1/2 | 38.0 | 0.05 | 0.07 | 56 | 82* |
| B905 | 5/16 | 8 | 0.55 | 14.0 | 250 | 1.7 | 2 | 51.0 | 0.08 | 0.12 | 56 | – |
| B906 | 3/8 | 10 | 0.64 | 16.3 | 250 | 1.7 | 3 | 76.0 | 0.09 | 0.13 | 56 | 82* |
| B908 | 1/2 | 12.5 | 0.78 | 19.8 | 250 | 1.7 | 3 | 76.0 | 0.13 | 0.19 | 56 | 82* |
| B910 | 5/8 | 16 | 0.92 | 23.4 | 250 | 1.7 | 4 | 102.0 | 0.20 | 0.30 | 56 | 82* |



WARNING

This product can expose you to chemicals including N-Methylpyrrolidone, which is known to the State of California to cause cancer. For more information go to www.P65Warnings.ca.gov.

5CNG - Compressed Natural Gas Hose

Electrically Conductive Nylon Core Tube

High pressure CNG transfer hose conforms to ANSI, CSA, ECE, and NFPA 52.



Features

- Electrically conductive core tube perforated polyurethane cover
- Sizes up to 1"
- Twin-line assemblies available to reduce installation time, eliminate tangling and reduce component part numbers

Construction

- Tube: Electrically Conductive Nylon
- Reinforcement: Aramid Fiber
- Cover: Polyurethane

Operating Parameters

- Temperature Range:
-40°F (-40°C) to 185°F (85°C)
- Vac. Rating: 28 inch Hg
- Change in length at Max. Working Pressure: +/-2%
- Min. Burst Pressure is 4x Max. Working Pressure at 73°F (23°C)

Color

- ● Red

Compliance

- ANSI/CSA NGV 4.2*CSA 12.52 (Class A, Class D)
- ECE R110 CNG Class 6
- ANSI NGV 3.1*CSA 12.3 (Class B - P36) 5CNG-8 only
- NFPA 52
- CSA Certified (www.csagroup.org)

Fittings

- CG Series - pg. E-72

Notes

- Perforated cover
- Assemblies only - CNG hose must be assembled at the factory or by a Parflex approved facility
- Appropriate wire and vinyl guards must be used on ANSI/CSA compliant single-line and twin-line bonded hose assemblies.
 - (-4 to -8 SS wire guards - pg. F-17)
 - (-12 & -16 Vinyl guards - pg. F-16)

Accessories

- 5PSG - Stainless steel spring guard
- CNGG5 - Vinyl hose guard

Series 5CNG

[Visit the webpage](#)

| Part Number | Nominal I.D. | | Maximum O.D. | | Maximum Working Pressure | | Minimum Bend Radius | | Weight | |
|-------------|--------------|------|--------------|------|--------------------------|------|---------------------|-------|----------|--------|
| | inch | mm | inch | mm | psi | MPa | inch | mm | lbs./ft. | kg/mtr |
| 5CNG-4 | 1/4 | 6.3 | 0.55 | 14.0 | 5,000 | 34.5 | 2 | 51.0 | 0.08 | 0.11 |
| 5CNG-6 | 3/8 | 10 | 0.65 | 16.5 | 5,000 | 34.5 | 3 | 76.0 | 0.09 | 0.13 |
| 5CNG-8 | 1/2 | 12.5 | 0.90 | 22.9 | 5,000 | 34.5 | 4 | 102.0 | 0.21 | 0.31 |
| 5CNG-12 | 3/4 | 19 | 1.19 | 30.2 | 5,000 | 34.5 | 7-1/2 | 191.0 | 0.24 | 0.36 |
| 5CNG-16 | 1 | 25 | 1.59 | 40.4 | 5,000 | 34.5 | 10 | 254.0 | 0.36 | 0.53 |



WARNING

This product can expose you to chemicals including Antimony Oxide (Antimony Trioxide), which is known to the State of California to cause cancer, and 2-Imidazolidinethione, which is known to the State of California to cause birth defects or other reproductive harm. For more information go to www.P65Warnings.ca.gov

CNGRP - Regulated Pressure Natural Gas Hose

Electrically Conductive Nylon Core Tube

Low pressure CNG transfer for on-vehicle use downstream of the pressure regulator.



Features

- For use downstream of the pressure regulator
- Approved for both under body and engine compartment installations

Compliance

- ANSI CSA NGV 3.1
- NFPA 52
- CSA 12.3, Class C
- CSA Certified (www.csagroup.org)

Construction

- Tube: Electrically Conductive Nylon
- Reinforcement: Stainless Steel
- Cover: TPV

Fittings

- 91N Series - pg. E-51
- | | | |
|---------------|---------------|---------------|
| 10691N-8-10C | 10691N-12-12C | 1JC91N-12-12C |
| 10691N-10-10C | 1AL91N-10-12C | 1TU91N-10-12C |
| 10691N-10-12C | 1AL91N-12-12C | 1TU91N-12-12C |

Operating Parameters

- Temperature Range:
-40°F (-40°C) to 250°F (121°C)
- Change in length at Max. Working Pressure: +2%/-4%
- Min. Burst Pressure is 4x Max. Working Pressure at 73°F (23°C)

Notes

- For use with natural gas only
- Factory-made assemblies only
- For sizes 3, 4 and 6 please contact the division for information on 8LPG hose which is certified according to ECE R 67 class 1, ECE R110 and AS/NZS 1869

Series CNGRP

[Visit the webpage](#)

| Part Number | Nominal I.D. | | Maximum O.D. | | Maximum Working Pressure | | Minimum Bend Radius | | Weight | |
|-------------|--------------|------|--------------|------|--------------------------|-----|---------------------|-------|----------|--------|
| | inch | mm | inch | mm | psi | MPa | inch | mm | lbs./ft. | kg/mtr |
| CNGRP-10 | 1/2 | 12.5 | 0.89 | 22.6 | 500 | 3.5 | 4 | 102.0 | 0.26 | 0.39 |
| CNGRP-12 | 5/8 | 16 | 1.04 | 26.4 | 500 | 3.5 | 5 | 127.0 | 0.30 | 0.45 |



WARNING

This product can expose you to chemicals including Antimony Oxide (Antimony Trioxide), which is known to the State of California to cause cancer, and 2-Imidazolidinethione, which is known to the State of California to cause birth defects or other reproductive harm. For more information go to www.P65Warnings.ca.gov

8LPG - Propane and Natural Gas Hose

Nylon Core Tube

In LPG and CNG systems, 8LPG hose allows for customization, reliability and versatility.



Features

- Flexibility and small bend radius makes mounting and installations easier and quicker
- Available in long lengths which reduces fitting components, weight and possible leak points
- Preformed hoses available for mounting in long chassis like buses and trucks

Construction

- Tube: Nylon (Polyamide)
- Reinforcement: Fiber
- Cover: Nylon (Polyamide)

Operating Parameters

- Temperature Range: :
 - LPG applications per ECE R67 within a temperature range of -13°F (-25°C) to 212°F (100°C) short time up to 212°F (125°C)
 - CNG applications per ECE R110 limited to -40°F (-40°C) to 212°F (100°C)
- Change in length at Max. Working Pressure: +2%/-2%
- Working Pressure at 73°F (23°C)

Compliance

- ECE R67 Class 1
- ECE R110
- AS/NZS 1869

Fittings

- PX-LPG Series Contact Parflex for options

Notes

- Perforated cover
- *Flame resistant cover, add -FR (*Improved mechanical and chemical protection through flame resistant 2nd outer cover)
- ** Pressure Values
 - For pressure values in bars, multiply the MPa value times 10
 - For pressure values in kPa, multiply the MPa value times 1,000
 - For pressure values in kgf/cm², multiply the MPa value times 10.2
- Factory-made assemblies only

Color

- ● Black

Series 8LPG

[Visit the webpage](#)

| Part Number | Hose Size | | Nominal I.D. | | Maximum O.D. | | Maximum Working Pressure | | Minimum Burst ECE R110 | | Minimum Burst ECE R67 | | Minimum Bend Radius | | Weight | |
|-------------|-----------|-----|--------------|------|--------------|------|--------------------------|-----|------------------------|-----|-----------------------|-----|---------------------|-----|----------|--------|
| | inch | mm | inch | mm | inch | mm | psi | MPa | psi | MPa | psi | MPa | inch | mm | lbs./ft. | kg/mtr |
| 8LPG-3 | 3/16 | 4.8 | .177 | 4.5 | .315 | 8.0 | 435 | 3.0 | 2,176 | 15 | 1,450 | 10 | 1.97 | 50 | 0.022 | 0.033 |
| 8LPG-3-FR* | | | .201 | 4.1 | .374 | 9.5 | | | | | | | | | 0.040 | 0.058 |
| 8LPG-4 | 1/4 | 6.3 | .236 | 6.0 | .386 | 9.8 | 435 | 3.0 | 2,176 | 15 | 1,450 | 10 | 2.95 | 75 | 0.029 | 0.043 |
| 8LPG-4-FR* | | | .260 | 6.6 | .453 | 11.5 | | | | | | | | | 0.048 | 0.071 |
| 8LPG-5 | 5/16 | 8 | .295 | 7.5 | .480 | 12.2 | 435 | 3.0 | 2,176 | 15 | 1,450 | 10 | 3.54 | 90 | 0.045 | 0.067 |
| 8LPG-5-FR* | | | .319 | 8.1 | .543 | 13.8 | | | | | | | | | 0.057 | 0.085 |
| 8LPG-6 | 3/8 | 10 | .362 | 9.2 | .539 | 13.7 | 435 | 3.0 | 2,176 | 15 | 1,450 | 10 | 3.94 | 100 | 0.050 | 0.075 |
| 8LPG-6-FR* | | | .394 | 10.0 | .602 | 15.3 | | | | | | | | | 0.060 | 0.090 |



WARNING

This product can expose you to chemicals including Titanium dioxide, which is known to the State of California to cause cancer. For more information go to www.P65Warnings.ca.gov.

HLB/HLBD - SAE 100R7 Hydraulic & Lubrication Hose

Copolyester Core Tube/Nylon Core Tube

Compact 1/8" I.D. hoses save hundreds of dollars of waste.



Features

- HLB/HLBD remote lubrication system versus 1/4" rubber hoses can save money per line in reduced component and installation labor costs
- Unique GK bulkhead hose fittings with integrated nipple can save money per zerk connection in unnecessary adapter costs
- Compact 1/8" hoses save hundreds of dollars of waste in your operation by eliminating gallons of unnecessary "in-line" grease versus larger bore rubber hoses

Construction

- Tube: HLBD02 - Nylon
HLB03 - Copolyester
- Reinforcement: Fiber
- Cover: Polyurethane

Operating Parameters

- Temperature Range:
 - Petroleum based hydraulic fluids and lubricating oils within a temperature range -40°F (-40°C) to 212°F (100°C)
 - Synthetic, synthetic blend, water, and water/oil emulsion hydraulic fluids limited to 135°F (57°C) (HLB03 only)
 - BU Series Field Attachable Fitting limited to 120°F (48°C)
- Vac. Rating: 28 inch Hg
- Change in length at Max. Working Pressure: +/-3%
- Min. Burst Pressure is 4x Max. Working Pressure at 73°F (23°C)

Compliance

- MSHA compliant cover
- Meets/Exceeds SAE J517 100R7 (HLBD)
- ISO 3949-R7-1 (HLBD)

Fittings

- CY Series - pg. E-62 BU Series - pg. E-31
- For most Parker products, Crimp Die Selection charts are found online at www.parker.com/crimpsource
- Access instructions are on pg. G-3

Notes

- Perforated cover - HLBD02
- Non-perforated cover - HLB03
- Field attachable fittings are not intended for use on hose that has been previously in service

Color

- ● Black

Series HLB/HLBD

[Visit the webpage](#)

| Part Number | Nominal I.D. | | Maximum O.D. | | Maximum Working Pressure | | Minimum Bend Radius | | Weight | | Permanent Fitting Series | Field Attachable Series |
|-------------|--------------|-----|--------------|------|--------------------------|------|---------------------|------|----------|--------|--------------------------|-------------------------|
| | inch | mm | inch | mm | psi | MPa | inch | mm | lbs./ft. | kg/mtr | | |
| HLBD02 | 1/8 | 3.2 | 0.32 | 8.1 | 3,000 | 20.7 | 1/2 | 13.0 | 0.03 | 0.04 | CY | BU |
| HLB03 | 3/16 | 5 | 0.41 | 10.4 | 3,000 | 20.7 | 3/4 | 19.0 | 0.06 | 0.08 | CY | - |

WARNING

This product can expose you to chemicals including Nickel compounds, which is known to the State of California to cause cancer, and Toluene, which is known to the State of California to cause birth defects or other reproductive harm. For more information go to www.P65Warnings.ca.gov.

MSH – Marine Steering Hose

Nylon Core Tube

Salt water resistant.



Features

- Fast, accurate response
- Permanent or field attachable fittings
- Salt water, corrosion resistant
- Ideal for marine hydraulic steering systems

Construction

- Tube: Nylon
- Reinforcement: Fiber
- Cover: Polyurethane

Operating Parameters

- Temperature Range:
-40°F (-40°C) to 200°F (93°C)
- Vac. Rating: 28 inch Hg
- Change in length at Max. Working Pressure: +/-2%
- Min. Burst Pressure is 4x Max. Working Pressure at 73°F (23°C)

Fittings

- MS Series – pg. E-65; E-80
- For most Parker products, Crimp Die Selection charts are found online at www.parker.com/crimpsource
- Access instructions are on pg. G-3

Notes

- Non-perforated cover
- Bend restrictor (HBR) available for only permanent fittings (pg. F-16)
- Field attachable fittings are not intended for use on hose that has been previously in service

Color

- ● Black

Series MSH

[Visit the webpage](#)

| Part Number | Nominal I.D. | | Maximum O.D. | | Maximum Working Pressure | | Minimum Bend Radius | | Weight | | Permanent Fitting Series | F.A. Fitting Series |
|-------------|--------------|----|--------------|------|--------------------------|-----|---------------------|------|----------|--------|--------------------------|---------------------|
| | inch | mm | inch | mm | psi | MPa | inch | mm | lbs./ft. | kg/mtr | | |
| MSH-5 | 5/16 | 8 | 0.48 | 12.2 | 1,000 | 6.9 | 2-1/4 | 57.0 | 0.05 | 0.07 | MS | MS |
| MSH-6 | 3/8 | 10 | 0.59 | 15.0 | 1,000 | 6.9 | 3 | 76.0 | 0.07 | 0.11 | MS | MS |



WARNING

This product can expose you to chemicals including Nickel compounds, which is known to the State of California to cause cancer, and Toluene, which is known to the State of California to cause birth defects or other reproductive harm. For more information go to www.P65Warnings.ca.gov.

MSXL - Fast Response Marine Steering Hose

Nylon Core Tube

Fast, accurate response with a salt water resistant cover.



Features

- Fast, accurate response in marine steering systems
- Low volumetric expansion
- Salt water resistant cover
- Ideal for marine hydraulic steering systems

Fittings

- MS Series - Permanent Crimp Only E-80
- For most Parker products, Crimp Die Selection charts are found online at www.parker.com/crimpsource
- Access instructions are on pg. G-3

Construction

- Tube: Nylon
- Reinforcement: Aramid Fiber
- Cover: Polyurethane

Notes

- Non-perforated cover
- Bend restrictor (HBR) available for only permanent fittings (pg. F-16)

Operating Parameters

- Temperature Range: -40°F (-40°C) to 185°F (85°C)
- Vac. Rating: 28 inch Hg
- Change in length at Max. Working Pressure: +/-2%
- Min. Burst Pressure is 4x Max. Working Pressure at 73°F (23°C)

Color

- ● Black

Series MSXL

[Visit the webpage](#)

| Part Number | Nominal I.D. | | Maximum O.D. | | Maximum Working Pressure | | Minimum Bend Radius | | Weight | | Permanent Fitting Series |
|-------------|--------------|----|--------------|------|--------------------------|------|---------------------|------|----------|--------|--------------------------|
| | inch | mm | inch | mm | psi | MPa | inch | mm | lbs./ft. | kg/mtr | |
| MSXL-5 | 5/16 | 8 | 0.50 | 12.7 | 1,500 | 10.3 | 2-1/4 | 57.0 | 0.05 | 0.07 | MS |

WARNING

This product can expose you to chemicals including Nickel compounds, which is known to the State of California to cause cancer, and Toluene, which is known to the State of California to cause birth defects or other reproductive harm. For more information go to www.P65Warnings.ca.gov.

PTH – Marine Power Tilt Hose

Nylon Core Tube

Designed for power tilt mechanisms, trim tab assemblies and jack plate assemblies.



Features

- Compact design
- Abrasion resistant polyurethane cover
- Excellent flexibility
- Corrosion resistant

Construction

- Tube: Nylon
- Reinforcement: Fiber and Stainless Steel Wire
- Cover: Polyurethane

Operating Parameters

- Temperature Range:
-40°F (-40°C) to 212°F (100°C)
- Change in length at Max. Working Pressure: +/-2%
- Min. Burst Pressure is 4x Max. Working Pressure at 73°F (23°C)

Fittings

- 92 Series – pg. E-61
- For most Parker products, Crimp Die Selection charts are found online at www.parker.com/crimpsource
- Access instructions are on pg. G-3

Notes

- Non-perforated cover
- Also available as custom order with black cover
- SS wire overbraid for enhanced kink resistance and cut through protection

Color

- Clear

Series PTH

[Visit the webpage](#)

| Part Number | Nominal I.D. | | Maximum O.D. | | Maximum Working Pressure | | Minimum Bend Radius | | Weight | | Permanent Fitting Series |
|-------------|--------------|----|--------------|------|--------------------------|------|---------------------|------|----------|--------|--------------------------|
| | inch | mm | inch | mm | psi | MPa | inch | mm | lbs./ft. | kg/mtr | |
| PTH-3 | 3/16 | 5 | 0.43 | 10.9 | 3,000 | 20.7 | 3/4 | 19.0 | 0.08 | 0.11 | 92 |



WARNING

This product can expose you to chemicals including Nickel compounds, which is known to the State of California to cause cancer, and Toluene, which is known to the State of California to cause birth defects or other reproductive harm. For more information go to www.P65Warnings.ca.gov.

S5N - Predator® Hose (Water Jetting/Lateral Cleaning) Nylon Core Tube

High-pressure water equipment
in lateral sewer lines.



Features

- Easily identified lime green cover signifies 4000 psi constant pressure
- Slim profile and light weight provide easy handling and routing
- High-pressure water equipment for cleaning or debris removal in lateral sewer lines

Fittings

- 56 Series - pg. E-33
- For most Parker products, Crimp Die Selection found online at www.parker.com/crimpsource
- Access instructions are on pg. G-3

Construction

- Tube: Gray Nylon
- Reinforcement: Aramid Fiber
- Cover: Polyurethane

Notes

- Perforated cover
- All standard assembly lengths coupled with rigid male pipe (NPT) each end
- Not for use in hydraulic applications

Operating Parameters

- Temperature Range:
-40°F (-40°C) to 135°F (57°C)
- Vac. Rating: 28 inch Hg
- Change in length at Max. Working Pressure: +/-2%
- Min. Burst Pressure is 4x Max. Working Pressure at 73°F (23°C)

Color

- ● Green

Series S5N

[Visit the webpage](#)

| Part Number | Nominal I.D. | | Maximum O.D. | | Maximum Working Pressure | | Minimum Bend Radius | | Weight | | Permanent Fitting Series |
|-------------|--------------|------|--------------|------|--------------------------|------|---------------------|-------|----------|--------|--------------------------|
| | inch | mm | inch | mm | psi | MPa | inch | mm | lbs./ft. | kg/mtr | |
| S508N | 1/2 | 12.5 | 0.81 | 20.6 | 4000 | 28.0 | 4 | 102.0 | 0.16 | 0.24 | 56 |

WARNING

This product can expose you to chemicals including Nickel compounds, which is known to the State of California to cause cancer, and Toluene, which is known to the State of California to cause birth defects or other reproductive harm. For more information go to www.P65Warnings.ca.gov.

S6 – Predator® Hose (Sewer Cleaning)

Copolyester Core Tube

2,500 psi pressure and high-volume water equipment in large sewer lines.



Features

- Easily identified orange cover signifies 2500 psi constant pressure
- Bonded construction provides excellent kink resistance and flexibility
- High-pressure and high-volume water equipment for cleaning or debris removal in large sewer lines

Construction

- Tube: Gray Copolyester
- Reinforcement: Fiber
- Cover: Polyurethane

Operating Parameters

- Temperature Range: -40°F (-40°C) to 135°F (57°C)
- Vac. Rating: 28 inch Hg
- Change in length at Max. Working Pressure: +/-2%
- Min. Burst Pressure is 2.5x Max. Working Pressure at 73°F (23°C)

Fittings

- SQ Series (Swage Only) – pg. E-82 HY Series - Fittings available from Parker Hose Products Division
- For most Parker products, Crimp Die Selection charts are found online at www.parker.com/crimpsource
- Access instructions are on pg. G-3

Notes

- All standard assembly lengths coupled with rigid male pipe (NPT) each end
- Not for use in hydraulic applications
- Perforated cover

Color

- ● Orange

Series S6

[Visit the webpage](#)

| Part Number | Nominal I.D. | | Maximum O.D. | | Maximum Working Pressure | | Minimum Bend Radius | | Weight | | Permanent Fitting Series |
|-------------|--------------|----|--------------|------|--------------------------|------|---------------------|-------|----------|--------|--------------------------|
| | inch | mm | inch | mm | psi | MPa | inch | mm | lbs./ft. | kg/mtr | |
| S612 | 3/4 | 19 | 1.15 | 29.2 | 2,500 | 17.2 | 4 | 102.0 | 0.27 | 0.40 | SQ/HY |
| S616 | 1 | 25 | 1.42 | 36.1 | 2,500 | 17.2 | 6 | 152.0 | 0.36 | 0.53 | SQ/HY |



WARNING

This product can expose you to chemicals including Nickel compounds, which is known to the State of California to cause cancer, and Toluene, which is known to the State of California to cause birth defects or other reproductive harm. For more information go to www.P65Warnings.ca.gov.

S9 – Predator® Hose (Sewer Cleaning)

Copolyester Core Tube

3,000 psi pressure and high-volume water equipment in large sewer lines.



Features

- Easily identified blue cover signifies 3000 psi constant pressure
- Bonded construction provides excellent kink resistance and flexibility
- High-pressure and high-volume water equipment for cleaning or debris removal in large sewer lines

Construction

- Tube: Gray Copolyester
- Reinforcement: Fiber
- Cover: Polyurethane

Operating Parameters

- Temperature Range: -40°F (-40°C) to 135°F (57°C)
- Vac. Rating: 28 inch Hg
- Change in length at Max. Working Pressure: +/-2%
- Min. Burst Pressure is 2.5x Max. Working Pressure at 73°F (23°C)

Fittings

- SQ Series (Swage Only) – pg. E-68 HY Series - Fittings available from Parker Hose Products Division
- For most Parker products, Crimp Die Selection charts are found online at www.parker.com/crimpsource
- Access instructions are on pg. G-3

Notes

- All standard assembly lengths coupled with rigid male pipe (NPT) each end
- Not for use in hydraulic applications
- Perforated cover

Color

- ● Blue

Series S9

[Visit the webpage](#)

| Part Number | Nominal I.D. | | Maximum O.D. | | Maximum Working Pressure | | Minimum Bend Radius | | Weight | | Permanent Fitting Series |
|-------------|--------------|----|--------------|------|--------------------------|------|---------------------|-------|----------|--------|--------------------------|
| | inch | mm | inch | mm | psi | MPa | inch | mm | lbs./ft. | kg/mtr | |
| S912 | 3/4 | 19 | 1.16 | 29.5 | 3,000 | 20.7 | 4 | 102.0 | 0.28 | 0.42 | SQ/HY |
| S916 | 1 | 25 | 1.48 | 37.6 | 3,000 | 20.7 | 8 | 203.0 | 0.41 | 0.61 | SQ/HY |

WARNING

This product can expose you to chemicals including Nickel compounds, which is known to the State of California to cause cancer, and Toluene, which is known to the State of California to cause birth defects or other reproductive harm. For more information go to www.P65Warnings.ca.gov.

919/919B - SAE 100R14 PTFE Hose

PTFE Core Tube

Best chemical resistance with high operating temperature (450°F/232°C).



Features

- Excellent chemical compatibility
- Handles extreme temperatures to 450°F
- Environmentally safe
- Resists moisture
- Low friction minimizes pressure drops and deposits

Construction

- Tube: 919 - Natural FDA Compliant PTFE
919B - Black Static-Dissipative PTFE
- Reinforcement: 304 Stainless Steel Braid

Operating Parameters

- Temperature Range:
-100°F (-73°C) to 450°F (232°C)
- Change in length at Max. Working Pressure: +2% to -4%
- Min. Burst Pressure is 4x Max. Working Pressure at 73°F (23°C)

Compliance

- Meets/Exceeds SAE J517 100R14A - 919
- Meets/Exceeds SAE J517 100R14B - 919B
- FDA CFR21 Part 177 compliant core - 919

Fittings

- 90 Series - pg. E-26 91/91N Series - pg. E-52
- For most Parker products, Crimp Die Selection charts are found online at www.parker.com/crimpsource
- Access instructions are on pg. G-3

Notes

- Use hose type 919B with static-dissipative core tube when conveying non-conducting fluids such as oils, paints, fuels, steam, etc.
- Constructed with minimum .030" PTFE tube wall thickness
- Field attachable fittings are not intended for use on hose that has been previously in service

Series 919/919B

[Visit the webpage](#)

| Part Number | | Nominal I.D. | | Maximum O.D. | | Maximum Working Pressure | | Minimum Bend Radius | | Vac. Rating | Weight | | Permanent Fitting Series | F.A. Fitting Series |
|-------------|--------------------|--------------|------|--------------|------|--------------------------|------|---------------------|-------|-------------|----------|--------|--------------------------|---------------------|
| Natural | Static-Dissipative | inch | mm | inch | mm | psi | MPa | inch | mm | Hg/73F | lbs./ft. | kg/mtr | | |
| 919-4 | 919B-4 | 3/16 | 5 | 0.33 | 8.2 | 3,000 | 20.7 | 2 | 50.0 | 28 | 0.06 | 0.09 | 91N | 90 |
| 919-5 | 919B-5 | 1/4 | 6.3 | 0.40 | 10.1 | 3,000 | 20.7 | 3 | 75.0 | 28 | 0.09 | 0.13 | 91N | 90 |
| 919-6 | 919B-6 | 5/16 | 8 | 0.46 | 11.6 | 2,500 | 17.2 | 4 | 100.0 | 28 | 0.10 | 0.15 | 91N | 90 |
| 919-8 | 919B-8 | 13/32 | 10.4 | 0.56 | 14.3 | 2,000 | 13.8 | 5 | 127.0 | 28 | 0.13 | 0.19 | 91N | 90 |
| 919-10 | - | 1/2 | 12.5 | 0.66 | 16.8 | 1,500 | 10.3 | 6-1/2 | 165.0 | 28 | 0.15 | 0.22 | 91N | 90 |
| 919-12 | - | 5/8 | 16 | 0.79 | 20.1 | 1,200 | 8.3 | 7-1/2 | 191.0 | 12 | 0.19 | 0.28 | 91N | 90 |
| 919-16 | - | 7/8 | 22 | 1.06 | 26.9 | 1,000 | 6.9 | 9 | 229.0 | 14 | 0.27 | 0.40 | 91N | 90 |
| 919-20 | - | 1-1/8 | 29 | 1.32 | 33.5 | 625 | 4.3 | 16 | 406.0 | 10 | 0.39 | 0.58 | 91 | 90 |



WARNING

This product can expose you to chemicals including Tetrafluoroethylene, which is known to the State of California to cause cancer. For more information go to www.P65Warnings.ca.gov.

919J/919BJ – Silicone Covered SAE 100R14 PTFE Hose

PTFE Core Tube

Steam cleanable with silicone cover for operator protection.



Features

- Silicone cover provides a clean, smooth cover to protect the stainless steel wire reinforcement against wear, fraying and contaminants
- Steam cleanable

Compliance

- Meets/Exceeds SAE J517 100R14A - 919J
- Meets/Exceeds SAE J517 100R14B - 919BJ
- FDA CFR21 Part 177 compliant core - 919J

Construction

- Tube: 919J - Natural FDA Compliant PTFE
919BJ - Black Static-Dissipative PTFE
- Reinforcement: 304 Stainless Steel Braid
- Cover: Extruded Silicone

Fittings

- 91N Series – pg. E-52
- For most Parker products, Crimp Die Selection charts are found online at www.parker.com/crimpsource
- Access instructions are on pg. G-3

Operating Parameters

- Temperature Range:
-40°F (-40°C) to 450°F (232°C)
- Change in length at Max. Working Pressure: +2% to -4%
- Min. Burst Pressure is 4x Max. Working Pressure at 73°F (23°C)

Notes

- Cover must be skived prior to fitting attachment
- Constructed with minimum .030" PTFE tube wall thickness

Color

- ● Red - 919J
- ● Orange - 919BJ

Series 919J/919BJ

[Visit the webpage](#)

| Part Number | | Nominal I.D. | | Maximum O.D. | | Maximum Working Pressure | | Minimum Bend Radius | | Vac. Rating | Weight | | Permanent Fitting Series |
|-------------|--------------------|--------------|------|--------------|------|--------------------------|------|---------------------|-------|-------------|----------|--------|--------------------------|
| Natural | Static-Dissipative | inch | mm | inch | mm | psi | MPa | inch | mm | Hg/73F | lbs./ft. | kg/mtr | |
| 919J-4-RED | 919BJ-4-ORG | 3/16 | 5 | 0.45 | 11.4 | 3,000 | 20.7 | 2 | 50.0 | 28 | 0.12 | 0.18 | 91N |
| 919J-5-RED | 919BJ-5-ORG | 1/4 | 6.3 | 0.52 | 13.2 | 3,000 | 20.7 | 3 | 75.0 | 28 | 0.14 | 0.21 | 91N |
| 919J-6-RED | 919BJ-6-ORG | 5/16 | 8 | 0.58 | 14.8 | 2,500 | 17.2 | 4 | 100.0 | 28 | 0.17 | 0.25 | 91N |
| 919J-8-RED | 919BJ-8-ORG | 13/32 | 10.4 | 0.68 | 17.3 | 2,000 | 13.8 | 5 | 127.0 | 28 | 0.20 | 0.30 | 91N |
| 919J-10-RED | 919BJ-10-ORG | 1/2 | 12.5 | 0.78 | 19.8 | 1,500 | 10.3 | 6-1/2 | 165.0 | 28 | 0.24 | 0.35 | 91N |
| 919J-12-RED | 919BJ-12-ORG | 5/8 | 16 | 0.91 | 23.1 | 1,200 | 8.3 | 7-1/2 | 191.0 | 12 | 0.29 | 0.43 | 91N |
| 919J-16-RED | 919BJ-16-ORG | 7/8 | 22 | 1.19 | 30.2 | 1,000 | 6.9 | 9 | 229.0 | 14 | 0.38 | 0.56 | 91N |

WARNING

This product can expose you to chemicals including Tetrafluoroethylene, which is known to the State of California to cause cancer. For more information go to www.P65Warnings.ca.gov.

919U - Abrasion Resistant SAE 100R14 PTFE Hose

PTFE Core Tube

Non-marring, abrasion resistant polyurethane cover.



Features

- Non-marring, abrasion resistant polyurethane cover protects the stainless steel wire reinforcement against wear, fraying and contaminants

Compliance

- Meets/Exceeds SAE J517 100R14A
 - Limited to temperature range of -40°F to 275°F
- FDA CFR21 Part 177 compliant core

Construction

- Tube: Natural FDA Compliant PTFE
- Reinforcement: 304 Stainless Steel Braid
- Cover: Polyurethane

Fittings

- 91N Series – pg. E-52
- For most Parker products, Crimp Die Selection charts are found online at www.parker.com/crimpsource
- Access instructions are on pg. G-3

Operating Parameters

- Temperature Range::
 - 40°F (-40°C) to 275°F (135°C)
- Change in length at Max. Working Pressure: +2% to -4%
- Min. Burst Pressure is 4x Max. Working Pressure at 73°F (23°C)

Notes

- Cover must be skived prior to fitting attachment
- Constructed with minimum .030" PTFE tube wall thickness

Color

- ● Black

Series 919U

[Visit the webpage](#)

| Part Number | Nominal I.D. | | Maximum O.D. | | Maximum Working Pressure | | Minimum Bend Radius | | Vac. Rating Hg/73F | Weight | | Permanent Fitting Series |
|-------------|--------------|------|--------------|------|--------------------------|------|---------------------|-------|-----------------------|----------|--------|--------------------------|
| | inch | mm | inch | mm | psi | MPa | inch | mm | | lbs./ft. | kg/mtr | |
| 919U-4 | 3/16 | 5 | 0.37 | 9.4 | 3,000 | 20.7 | 2 | 50.0 | 28 | 0.08 | 0.13 | 91N |
| 919U-6 | 5/16 | 8 | 0.51 | 13.0 | 2,500 | 17.2 | 4 | 100.0 | 28 | 0.13 | 0.20 | 91N |
| 919U-8 | 13/32 | 10.4 | 0.61 | 15.5 | 2,000 | 13.8 | 5 | 127.0 | 28 | 0.15 | 0.22 | 91N |
| 919U-12 | 5/8 | 16 | 0.84 | 21.4 | 1,200 | 8.3 | 7-1/2 | 191.0 | 12 | 0.22 | 0.33 | 91N |
| 919U-16 | 7/8 | 22 | 1.12 | 28.5 | 1,000 | 6.9 | 9 | 229.0 | 14 | 0.31 | 0.47 | 91N |



WARNING

This product can expose you to chemicals including Tetrafluoroethylene, which is known to the State of California to cause cancer. For more information go to www.P65Warnings.ca.gov.

929/929B - Heavy Wall SAE 100R14 PTFE Hose

PTFE Core Tube

Enhanced resistance to gas permeation due to increased PTFE wall thickness (.040").



Features

- Excellent kink resistance
- Enhanced resistance to gas permeation due to increased PTFE wall thickness (.040")
- Excellent chemical compatibility
- Handles extreme temperatures to 450°F

Construction

- Tube: 929 - Natural FDA Compliant PTFE
929B - Black Static-Dissipative PTFE
- Reinforcement: 304 Stainless Steel Braid

Operating Parameters

- Temperature Range:
-100°F (-73°C) to 450°F (232°C)
- Change in length at Max. Working Pressure: +2% to -4%
- Min. Burst Pressure is 4x Max. Working Pressure at 73°F (23°C)

Compliance

- Meets/Exceeds SAE J517 100R14A - 929
- Meets/Exceeds SAE J517 100R14B - 929B
- FDA CFR21 Part 177 compliant core - 929

Fittings

- 91N Series - pg. E-52
- For most Parker products, Crimp Die Selection charts are found online at www.parker.com/crimpsource
- Access instructions are on pg. G-3

Notes

- Use hose type 929B with static-dissipative core tube when conveying non-conducting fluids such as oils, paints, fuels, steam, etc.
- Constructed with minimum .040" PTFE tube wall thickness

Series 929/929B

[Visit the webpage](#)

| Part Number | | Nominal I.D. | | Maximum O.D. | | Maximum Working Pressure | | Minimum Bend Radius | | Vac. Rating | Weight | | Permanent Fitting Series |
|-------------|--------------------|--------------|----|--------------|------|--------------------------|------|---------------------|-------|-------------|----------|--------|--------------------------|
| Natural | Static-Dissipative | inch | mm | inch | mm | psi | MPa | inch | mm | Hg/73F | lbs./ft. | kg/mtr | |
| 929-4 | 929B-4 | 3/16 | 5 | 0.34 | 8.6 | 3,000 | 20.7 | 2 | 51.0 | 28 | 0.08 | 0.12 | 91N |
| 929-6 | 929B-6 | 5/16 | 8 | 0.47 | 11.9 | 2,500 | 17.2 | 4 | 102.0 | 28 | 0.12 | 0.18 | 91N |
| 929-8 | 929B-8 | 13/32 | 10 | 0.59 | 15.0 | 2,000 | 13.8 | 4-5/8 | 117.0 | 28 | 0.16 | 0.23 | 91N |
| - | 929B-12 | 5/8 | 16 | 0.75 | 19.1 | 1,200 | 8.3 | 6-1/2 | 165.0 | 12 | 0.19 | 0.28 | 91N |
| - | 929B-16 | 7/8 | 22 | 1.14 | 29.0 | 1,250 | 8.6 | 7-1/2 | 188.0 | 12 | 0.49 | 0.73 | 91N |



WARNING

This product can expose you to chemicals including Tetrafluoroethylene, which is known to the State of California to cause cancer. For more information go to www.P65Warnings.ca.gov.

929BJ - Silicone Covered SAE 100R14 PTFE Hose

PTFE Core Tube

Silicone cover protects SS wire reinforcement against wear and fraying, up to 450°F.



Features

- Silicone cover protects SS wire reinforcement against wear and fraying, up to 450°F
- Silicone cover provides clean, smooth cover and prevents contaminants from accumulating in braid
- Excellent kink resistance
- Enhanced resistance to gas permeation due to increased PTFE wall thickness
- Steam cleanable

Construction

- Tube: Black Static-Dissipative PTFE
- Reinforcement: 304 Stainless Steel Braid
- Cover: Silicone

Operating Parameters

- Temperature Range: -65°F (-54°C) to 450°F (232°C)
- Change in length at Max. Working Pressure: +2% to -4%
- Min. Burst Pressure is 4x Max. Working Pressure at 73°F (23°C)

Compliance

- Meets/Exceeds SAE J517 100R14B

Fittings

- 91N Series – pg. E-52
- For most Parker products, Crimp Die Selection charts are found online at www.parker.com/crimpsource
- Access instructions are on pg. G-3

Notes

- Cover must be skived prior to fitting attachment
- Constructed with minimum .040" PTFE tube wall thickness

Color

- ● Brown

Series 929BJ

[Visit the webpage](#)

| Part Number | Nominal I.D. | | Maximum O.D. | | Maximum Working Pressure | | Minimum Bend Radius | | Vac. Rating | Weight | | Permanent Fitting Series |
|-------------|--------------|----|--------------|------|--------------------------|------|---------------------|-------|-------------|--------|----------|--------------------------|
| | inch | mm | inch | mm | psi | MPa | inch | mm | | Hg/73F | lbs./ft. | |
| 929BJ-4 | 3/16 | 5 | 0.58 | 14.7 | 3,000 | 20.7 | 2 | 51.0 | 28 | 0.17 | 0.25 | 91N |
| 929BJ-6 | 5/16 | 8 | 0.70 | 17.8 | 2,500 | 17.2 | 4 | 102.0 | 28 | 0.23 | 0.34 | 91N |
| 929BJ-8 | 13/32 | 10 | 0.81 | 20.6 | 2,000 | 13.8 | 4-5/8 | 117.0 | 28 | 0.29 | 0.43 | 91N |
| 929BJ-12 | 5/8 | 16 | 1.04 | 26.4 | 1,200 | 8.3 | 6-1/2 | 165.0 | 12 | 0.43 | 0.64 | 91N |
| 929BJ-16 | 7/8 | 22 | 1.36 | 34.5 | 1,250 | 8.6 | 7-1/2 | 188.0 | 12 | 0.78 | 1.16 | 91N |



WARNING

This product can expose you to chemicals including Tetrafluoroethylene, which is known to the State of California to cause cancer. For more information go to www.P65Warnings.ca.gov.

939/939B – Convoluted PTFE Hose

PTFE Core Tube

Up to 50% tighter bend radius than smoothbore PTFE hose.



Features

- Excellent flexibility for tighter routings
- Excellent kink resistance

Compliance

- FDA CFR21 Part 177 compliant core - 939

Construction

- Tube: 939 - Natural FDA Compliant PTFE
939B - Black Static-Dissipative PTFE
- Reinforcement: 304 Stainless Steel Braid

Fittings

- 93N Series – pg. E-62
- For most Parker products, Crimp Die Selection charts are found online at www.parker.com/crimpsource
- Access instructions are on pg. G-3

Operating Parameters

- Temperature Range:
-100°F (-73°C) to 450°F (232°C)
- Change in length at Max. Working Pressure: +/-2%
- Min. Burst Pressure is 4x Max. Working Pressure at 73°F (23°C)

Notes

- Use hose type 939B with static-dissipative core tube when conveying non-conducting fluids such as paints, fuels, steam, etc.
- *28 in/Hg can be obtained by using an internal spring guard See pg. F-20

Series 939/939B

[Visit the webpage](#)

| Part Number | | Nominal I.D. | | Maximum O.D. | | Maximum Working Pressure | | Minimum Bend Radius | | Vac. Rating | Weight | | Permanent Fitting Series |
|-------------|--------------------|--------------|------|--------------|------|--------------------------|------|---------------------|-------|-------------|----------|--------|--------------------------|
| Natural | Static-Dissipative | inch | mm | inch | mm | psi | MPa | inch | mm | Hg/73F | lbs./ft. | kg/mtr | |
| 939-6 | 939B-6 | 3/8 | 10 | 0.59 | 15.0 | 1500 | 10.3 | 2-1/4 | 57.0 | 28 | 0.12 | 0.18 | 93N |
| 939-8 | 939B-8 | 1/2 | 12.5 | 0.79 | 20.1 | 1350 | 9.3 | 2-7/8 | 73.0 | 28 | 0.21 | 0.31 | 93N |
| 939-10 | 939B-10 | 5/8 | 16 | 0.88 | 22.4 | 1000 | 6.9 | 3 | 76.0 | 28 | 0.24 | 0.36 | 93N |
| 939-12 | 939B-12 | 3/4 | 19 | 1.09 | 27.7 | 1100 | 7.6 | 3-3/4 | 95.0 | 28 | 0.32 | 0.47 | 93N |
| 939-16 | 939B-16 | 1 | 25 | 1.33 | 33.8 | 1000 | 6.9 | 5 | 127.0 | 28 | 0.45 | 0.67 | 93N |
| 939-20 | 939B-20 | 1-1/4 | 31.5 | 1.75 | 44.5 | 1000 | 6.9 | 6-1/4 | 159.0 | 20* | 0.70 | 1.04 | 93N |
| 939-24 | 939B-24 | 1-1/2 | 38 | 2.05 | 52.1 | 750 | 5.2 | 7-1/2 | 191.0 | 12* | 0.80 | 1.18 | 93N |
| 939-32 | 939B-32 | 2 | 51 | 2.56 | 65.0 | 250 | 1.7 | 10 | 254.0 | 5* | 1.01 | 1.50 | 93N |

WARNING

This product can expose you to chemicals including Tetrafluoroethylene, which is known to the State of California to cause cancer. For more information go to www.P65Warnings.ca.gov.

944B - High Pressure PTFE Hose

Static Dissipative PTFE Core Tube

Up to 4,500 working pressure.
Low friction minimizes pressure drops.



Features

- Excellent chemical compatibility
- Resists moisture
- Low friction minimizes pressure drops and deposits

Fittings

- 94 Series - pg. E-64

Construction

- Tube: Black Static-Dissipative PTFE
- Reinforcement: 304 Stainless Steel Braid

Notes

- Factory made assemblies only
- Reduce pressure to 3000 psi (20.7 MPa) for pressure impulse applications

Operating Parameters

- Temperature Range:
-65°F (-54°C) to 400°F (204°C)
- Change in length at Max. Working Pressure: +/-2%
- Min. Burst Pressure is 3x Max. Working Pressure at 73°F (23°C)

Series 944B

[Visit the webpage](#)

| Part Number | Nominal I.D. | | Maximum O.D. | | Maximum Working Pressure | | Minimum Bend Radius | | Vac. Rating Hg/73F | Weight | |
|-------------|--------------|------|--------------|------|--------------------------|------|---------------------|-------|-----------------------|----------|--------|
| | inch | mm | inch | mm | psi | MPa | inch | mm | | lbs./ft. | kg/mtr |
| 944B-6 | 5/16 | 8 | 0.49 | 12.5 | 4,500 | 31.0 | 2-1/2 | 63.5 | 28 | 0.17 | 0.24 |
| 944B-8 | 7/16 | 10.4 | 0.62 | 15.6 | 4,500 | 31.0 | 2-7/8 | 73.2 | 28 | 0.25 | 0.35 |
| 944B-10 | 1/2 | 12.5 | 0.73 | 18.5 | 4,000 | 27.6 | 3-1/4 | 82.6 | 28 | 0.31 | 0.45 |
| 944B-12 | 5/8 | 16 | 0.99 | 25.1 | 4,000 | 27.6 | 4 | 101.6 | 28 | 0.74 | 1.05 |
| 944B-16 | 29/32 | 22 | 1.25 | 31.8 | 4,000 | 27.6 | 5 | 127.0 | 28 | 1.09 | 1.55 |



WARNING

This product can expose you to chemicals including Tetrafluoroethylene, which is known to the State of California to cause cancer. For more information go to www.P65Warnings.ca.gov.

955B - High Pressure PTFE Hose

Static Dissipative PTFE Core Tube

5,500 constant working pressure.
Low friction minimizes pressure drops.



Features

- Excellent chemical compatibility
- Resists moisture
- Low friction minimizes pressure drops and deposits

Fittings

- 95 Series - pg. E-64

Construction

- Tube: Black Static-Dissipative PTFE
- Reinforcement: Multiple high density braids of 304 Stainless Steel

Notes

- Factory-made assemblies only
- Reduce pressure to **4,000 psi (27.6 MPa)** for pressure impulse applications

Operating Parameters

- Temperature Range:
-65°F (-54°C) to 400°F (204°C)
- Change in length at Max. Working Pressure: +/-2%
- Min. Burst Pressure is 16,000 psi at 73°F (23°C)

Series 955B

[Visit the webpage](#)

| Part Number | Nominal I.D. | | Maximum O.D. | | Maximum Working Pressure | | Minimum Bend Radius | | Vac. Rating | Weight | |
|-------------|--------------|------|--------------|------|--------------------------|------|---------------------|-------|-------------|--------|--------|
| | Natural | inch | mm | inch | mm | psi | MPa | inch | | mm | Hg/73F |
| 955B-4 | 15/64 | 6 | 0.50 | 12.7 | 5,500 | 37.9 | 3 | 76.0 | 28 | 0.23 | 0.34 |
| 955B-6 | 5/16 | 8 | 0.62 | 15.7 | 5,500 | 37.9 | 5 | 127.0 | 28 | 0.24 | 0.35 |
| 955B-8 | 7/16 | 11.1 | 0.75 | 19.1 | 5,500 | 37.9 | 5-3/4 | 146.0 | 28 | 0.46 | 0.68 |
| 955B-10 | 1/2 | 12.7 | 0.91 | 23.1 | 5,500 | 37.9 | 6-1/2 | 165.0 | 28 | 0.91 | 1.34 |
| 955B-12 | 5/8 | 16 | 1.08 | 27.4 | 5,500 | 37.9 | 7-3/4 | 197.0 | 28 | 0.92 | 1.36 |
| 955B-16 | 29/32 | 23 | 1.36 | 34.5 | 5,500 | 37.9 | 9-5/8 | 245.0 | 28 | 1.20 | 1.77 |

WARNING

This product can expose you to chemicals including Tetrafluoroethylene, which is known to the State of California to cause cancer. For more information go to www.P65Warnings.ca.gov.

STW/STB True Bore PTFE Hose

PTFE Core Tube

Features a larger I.D. than the equivalent SAE J517, 100R14 PTFE hose.



Features

- High temperature hose
- Excellent chemical compatibility
- Resists moisture
- Low friction minimizes pressure drops and deposits

Construction

- Tube: STW - Natural FDA Compliant PTFE
STB - Black Static-Dissipative PTFE
- Reinforcement: 304 Stainless Steel Braid

Operating Parameters

- Temperature Range:
-100°F (-73°C) to 450°F (232°C)
- Change in length at Max. Working Pressure: +2% to -4%
- Min. Burst Pressure is 4x Max. Working Pressure at 73°F (23°C)
- Pressure ratings based on 73°F (23°C) - Decrease working pressure 1% for every 2°F above 212°F

Compliance

- FDA CFR21 Part 177 compliant core - STW
- USP Class VI compliant core

Fittings

- PAGE Fittings – pg. E-65
- Uses crimp collar ST300, see pg. E-66
- For most Parker products, Crimp Die Selection charts are found online at www.parker.com/crimpsource
- Access instructions are on pg. G-3

Notes

- "Z" indicates double braid
- See pg. A-21 for part numbering system
- Cannot be used with 90 or 91N series fittings

Series STW/STB

[Visit the webpage](#)

| Part Number | | Nominal I.D. | | Maximum O.D. | | Maximum Working Pressure | | Minimum Bend Radius | | Vac. Rating | Weight | | Permanent Fitting Series |
|-------------|--------------------|--------------|------|--------------|------|--------------------------|-----|---------------------|-----|-------------|----------|--------|--------------------------|
| Natural | Static-Dissipative | inch | mm | inch | mm | psi | MPa | inch | mm | Hg/73F | lbs./ft. | kg/mtr | |
| 04-STW | 04-STB | 1/4 | 6 | .37 | 9 | 3,000 | 207 | 3 | 76 | 28 | .08 | .13 | PAGE |
| 06-STW | 06-STB | 3/8 | 10 | .51 | 13 | 2,000 | 138 | 5 | 127 | 28 | .11 | .16 | PAGE |
| 08-STW | 08-STB | 1/2 | 13 | .63 | 16 | 1,750 | 121 | 6-1/2 | 165 | 28 | .16 | .24 | PAGE |
| 12-STW | 12-STB | 3/4 | 19 | .88 | 22 | 1,000 | 69 | 8.5 | 216 | 28 | .20 | .30 | PAGE |
| 16-STW | 16-STB | 1 | 25 | 1.13 | 29 | 1,000 | 69 | 12 | 305 | 20 | .33 | .49 | PAGE |
| 20Z-STW | 20Z-STB | 1-1/4 | 31.8 | 1.52 | 38.6 | 1,000 | 69 | 14 | 356 | 18 | .68 | 1.02 | PAGE |
| 24Z-STW | 24Z-STB | 1-1/2 | 38.1 | 1.73 | 43.9 | 900 | 62 | 15 | 381 | 15 | .79 | 1.18 | PAGE |



WARNING

This product can expose you to chemicals including Tetrafluoroethylene, which is known to the State of California to cause cancer. For more information go to www.P65Warnings.ca.gov.

SCW/SCB - Convoluted PTFE Hose

PTFE Core Tube

Features extreme flexibility with stainless steel braid reinforcement.



Features

- Excellent corrosion resistance
- Seamless
- Open pitch
- Self draining
- Environmentally safe; low effusion

Construction

- Tube: SCW - Natural FDA Compliant PTFE
SCB - Black Static-Dissipative PTFE
- Reinforcement: 304 Stainless Steel Braid

Operating Parameters

- Temperature Range:
-100°F (-73°C) to 500°F (260°C)
- Change in length at Max. Working Pressure: +2% to -4%
- Min. Burst Pressure is 4x Max. Working Pressure at 73°F (23°C)
- Pressure ratings based on 73°F (23°C)
- Decrease working pressure 1% for every 2°F above 212°F

Compliance

- FDA CFR21 Part 177 compliant core - SCW
- USP Class VI compliant core

Fittings

- PAGE Fittings - pg. E-65
- Uses crimp collar SC300, see pg. E-66
- For most Parker products, Crimp Die Selection charts are found online at www.parker.com/crimpsource
- Access instructions are on pg. G-3

Notes

- See pg. A-21 for part numbering system
- Cannot be used with 93N series fittings

Series SCW/SCB

[Visit the webpage](#)

| Part Number | | Nominal I.D. | | Maximum O.D. | | Maximum Working Pressure | | Minimum Bend Radius | | Vac. Rating | Weight | | Permanent Fitting Series |
|-------------|--------------------|--------------|------|--------------|------|--------------------------|------|---------------------|-------|-------------|----------|--------|--------------------------|
| Natural | Static-Dissipative | inch | mm | inch | mm | psi | MPa | inch | mm | Hg/73F | lbs./ft. | kg/mtr | |
| 04-SCW | 04-SCB | 1/4 | 6.4 | 0.46 | 11.7 | 1,500 | 10.3 | 3/4 | 19.0 | 28 | 0.08 | 0.11 | PAGE |
| 06-SCW | 06-SCB | 3/8 | 9.5 | 0.56 | 14.2 | 1,500 | 10.3 | 1 | 25.0 | 28 | 0.10 | 0.15 | PAGE |
| 08-SCW | 08-SCB | 1/2 | 12.7 | 0.76 | 19.3 | 1,500 | 10.3 | 1-1/2 | 38.0 | 28 | 0.16 | 0.23 | PAGE |
| 12-SCW | 12-SCB | 3/4 | 19.1 | 1.03 | 26.2 | 1,200 | 8.3 | 2 | 51.0 | 28 | 0.27 | 0.40 | PAGE |
| 16-SCW | 16-SCB | 1 | 25.4 | 1.34 | 34.0 | 925 | 6.4 | 2-1/2 | 64.0 | 28 | 0.37 | 0.55 | PAGE |
| 20-SCW | 20-SCB | 1-1/4 | 31.8 | 1.75 | 44.5 | 750 | 5.2 | 3 | 76.0 | 28 | 0.46 | 0.68 | PAGE |
| 24-SCW | 24-SCB | 1-1/2 | 38.1 | 1.95 | 49.5 | 650 | 4.5 | 3-3/4 | 95.0 | 28 | 0.55 | 0.81 | PAGE |
| 32-SCW | 32-SCB | 2 | 50.8 | 2.45 | 62.2 | 450 | 3.1 | 4-3/4 | 121.0 | 28 | 0.90 | 1.40 | PAGE |



WARNING

This product can expose you to chemicals including Tetrafluoroethylene, which is known to the State of California to cause cancer. For more information go to www.P65Warnings.ca.gov.

SCWV/SCBV Heavy Wall Convuluted PTFE Hose

PTFE Core Tube

Thicker wall handles vacuum applications at elevated temperatures.



Features

- Thicker wall - up to 33% more PTFE than SCW
- Handles vacuum applications at elevated temperatures
- Excellent chemical compatibility
- Easy Cleaning

Construction

- Tube: SCWV - Natural FDA Compliant PTFE
SCBV - Black Static-Dissipative PTFE
- Reinforcement: 304 Stainless Steel Braid

Operating Parameters

- Temperature Range:
-100°F (-73°C) to 500°F (260°C)
- Change in length at Max. Working Pressure: +2% to -4%
- Min. Burst Pressure is 4x Max. Working Pressure at 73°F (23°C)
- Pressure ratings based on 73°F (23°C)
- Decrease working pressure 1% for every 2°F above 212°F

Compliance

- FDA CFR21 Part 177 compliant core - SCWV
- USP Class VI compliant core

Fittings

- PAGE Fittings - pg. E-65

Notes

- Factory-made assemblies only
- See pg. A-21 for part numbering system
- **Cannot be used with 93N Series Fittings**
- *Vacuum wire recommended to achieve 28 inch rating

Series SCWV/SCBV

[Visit the webpage](#)

| Part Number | | Nominal I.D. | | Maximum O.D. | | Max. Working Pressure 73°F / 23°C | | Minimum Bend Radius | | Vac. Rating | Weight | |
|-------------|--------------------|--------------|------|--------------|------|-----------------------------------|------|---------------------|-------|-------------|----------|--------|
| Natural | Static-Dissipative | inch | mm | inch | mm | psi | MPa | inch | mm | Hg/73F | lbs./ft. | kg/mtr |
| 08-SCWV | 08-SCBV | 1/2 | 12.7 | 0.76 | 19.3 | 1,500 | 10.3 | 2 | 51.0 | 28 | 0.17 | 0.26 |
| 12-SCWV | 12-SCBV | 3/4 | 19.1 | 1.05 | 26.6 | 1,200 | 8.3 | 2-3/4 | 70.0 | 28 | 0.33 | 0.49 |
| 16-SCWV | 16-SCBV | 1 | 25.4 | 1.27 | 32.2 | 1,000 | 6.9 | 4 | 102.0 | 28 | 0.37 | 0.55 |
| 20-SCWV | 20-SCBV | 1-1/4 | 31.8 | 1.67 | 42.4 | 750 | 5.2 | 5-1/2 | 140.0 | 28 | 0.56 | 0.83 |
| 24-SCWV | 24-SCBV | 1-1/2 | 38.1 | 1.94 | 49.2 | 650 | 4.5 | 7 | 178.0 | 28 | 0.64 | 0.95 |
| 32-SCWV | 32-SCBV | 2 | 50.8 | 2.49 | 63.2 | 450 | 3.1 | 8-1/2 | 216.0 | 28 | 0.84 | 1.24 |
| 40-SCWV | 40-SCBV | 2-1/2 | 63.5 | 3.29 | 83.5 | 200 | 1.4 | 12 | 305.0 | 28* | 1.52 | 2.26 |
| 48-SCWV | 48-SCBV | 3 | 76.2 | 3.83 | 97.3 | 175 | 1.2 | 14 | 356.0 | 28* | 1.82 | 2.71 |



WARNING

This product can expose you to chemicals including Tetrafluoroethylene, which is known to the State of California to cause cancer. For more information go to www.P65Warnings.ca.gov.

PCW/PCB – Convoluted PTFE Hose, Polypropylene Braid PTFE Core Tube

Polypropylene adds personal handling safety.



Features

- Excellent corrosion resistance
- Seamless
- Open pitch
- Self draining
- Withstands extreme flexing
- Environmentally safe; low effusion
- Long life expectancy

Construction

- Tube: PCW - Natural FDA Compliant PTFE
PCB - Black Static-Dissipative PTFE
- Reinforcement: Polypropylene Braid

Operating Parameters

- Temperature Range: 0°F (18°C) to 212°F (100°C)
- Change in length at Max. Working Pressure: +2% to -4%
- Min. Burst Pressure is 4x Max. Working Pressure at 73°F (23°C)
- Pressure ratings based on 73°F (23°C)
- Decrease working pressure 1% for every 2°F above 212°F

Compliance

- FDA CFR21 Part 177 compliant core - PCW
- USP Class VI compliant core

Fittings

- PAGE Fittings – pg. E-65
- Uses crimp collar PC300, see pg. E-66
- For most Parker products, Crimp Die Selection charts are found online at www.parker.com/crimpsource
- Access instructions are on pg. G-3

Notes

- Not suggested for steam-cold water cycling applications
- See pg. A-21 for part numbering system
- Cannot be used with 93N series fittings

Series PCW/PCB

[Visit the webpage](#)

| Part Number | | Nominal I.D. | | Maximum O.D. | | Maximum Working Pressure | | Minimum Bend Radius | | Vac. Rating | Weight | | Permanent Fitting Series |
|-------------|--------------------|--------------|------|--------------|------|--------------------------|-----|---------------------|-------|-------------|----------|--------|--------------------------|
| Natural | Static-Dissipative | inch | mm | inch | mm | psi | MPa | inch | mm | Hg/73F | lbs./ft. | kg/mtr | |
| 04-PCW | 04-PCB | 1/4 | 6.4 | 0.56 | 14.2 | 350 | 2.4 | 3/4 | 19.0 | 28 | 0.03 | 0.05 | PAGE |
| 06-PCW | 06-PCB | 3/8 | 9.5 | 0.65 | 16.5 | 350 | 2.4 | 1 | 25.0 | 28 | 0.06 | 0.09 | PAGE |
| 08-PCW | 08-PCB | 1/2 | 12.7 | 0.85 | 21.6 | 300 | 2.1 | 1-1/2 | 38.0 | 28 | 0.15 | 0.22 | PAGE |
| 12-PCW | 12-PCB | 3/4 | 19.1 | 1.17 | 29.7 | 250 | 1.7 | 2 | 51.0 | 28 | 0.18 | 0.27 | PAGE |
| 16-PCW | 16-PCB | 1 | 25.4 | 1.52 | 38.6 | 250 | 1.7 | 2-1/2 | 64.0 | 28 | 0.26 | 0.39 | PAGE |
| 20-PCW | 20-PCB | 1-1/4 | 31.8 | 1.94 | 49.3 | 200 | 1.4 | 3 | 76.0 | 28 | 0.37 | 0.55 | PAGE |
| 24-PCW | 24-PCB | 1-1/2 | 38.1 | 2.14 | 54.4 | 200 | 1.4 | 3-3/4 | 95.0 | 28 | 0.42 | 0.63 | PAGE |
| 32-PCW | 32-PCB | 2 | 50.8 | 2.67 | 67.8 | 200 | 1.4 | 4-3/4 | 121.0 | 28 | 0.56 | 0.83 | PAGE |

WARNING

This product can expose you to chemicals including Tetrafluoroethylene, which is known to the State of California to cause cancer. For more information go to www.P65Warnings.ca.gov.

NCW/NCB – Convoluted PTFE, Nomex® Braid PTFE Core Tube

Hose
A

Eliminates RFI issues.



Tubing
Thermoplastic
B

Features

- Very light weight
- Superior flexibility
- Kink and vacuum resistant
- Eliminates RFI issues



Compliance

- FDA CFR21 Part 177 compliant core - NCW
- USP Class VI compliant core

Coiled Air Hose
& Fittings
C

Construction

- Tube: NCW - Natural FDA Compliant PTFE
NCB - Black Static-Dissipative PTFE
- Reinforcement: Nomex braid

Fittings

- PAGE Fittings – pg. E-65

Operating Parameters

- Temperature Range:
-100°F (-73°C) to 400°F (204°C)
- Change in length at Max. Working Pressure: +2% to -4%
- Min. Burst Pressure is 4x Max. Working Pressure at 73°F (23°C)
- Pressure ratings based on 73°F (23°C)
- Decrease working pressure 1% for every 2°F above 212°F

Notes

- Factory-made assemblies only
- NCB (Static Dissipative) tube I.D. surface only
- NCB Conductive Spec - Must conduct 20 microamps 1000 VDC potential 14" sample
- See pg. A-21 for part numbering system
- **Cannot be used with 93N series fittings**

Transportation
D

Color

- ● Green

Fittings
E

Series NCW/NCB

[Visit the webpage](#)

| Part Number | | Nominal I.D. | | Maximum O.D. | | Max. Working Pressure 73°F / 23°C | | Minimum Bend Radius | | Vac. Rating | Weight | |
|-------------|--------------------|--------------|------|--------------|------|-----------------------------------|-----|---------------------|-------|-------------|----------|--------|
| Natural | Static-Dissipative | inch | mm | inch | mm | psi | MPa | inch | mm | Hg/73F | lbs./ft. | kg/mtr |
| 04-NCW | 04-NCB | 1/4 | 6.4 | 0.48 | 12.2 | 725 | 5.0 | 1 | 25.0 | 28 | 0.02 | 0.03 |
| 06-NCW | 06-NCB | 3/8 | 10 | 0.58 | 14.7 | 400 | 2.8 | 1-1/2 | 38.0 | 28 | 0.06 | 0.09 |
| 08-NCW | 08-NCB | 1/2 | 12.5 | 0.77 | 19.5 | 280 | 1.9 | 2 | 51.0 | 28 | 0.08 | 0.12 |
| 12-NCW | 12-NCB | 3/4 | 19 | 1.05 | 26.7 | 200 | 1.4 | 2-1/2 | 64.0 | 28 | 0.14 | 0.21 |
| 16-NCW | 16-NCB | 1 | 25 | 1.33 | 33.8 | 200 | 1.4 | 4 | 102.0 | 28 | 0.22 | 0.32 |

Tooling, Equipment
& Accessories
F

Nomex® is a registered trademark of E. I. du Pont de Nemours and Company.



WARNING

This product can expose you to chemicals including Tetrafluoroethylene, which is known to the State of California to cause cancer. For more information go to www.P65Warnings.ca.gov.

General Technical
G

2245N - High Pressure Hose

Polyamide Core Tube

Excellent chemical resistance.



Features

- Excellent chemical resistance
- Use for high pressure service

Compliance

- Meets/Exceeds
 - SAE J517 100R2AT performance
 - ISO 1436, Type 2SN

Construction

- Tube: Polyamide
- Reinforcement: Two spiral layers of high tensile steel wire, one braided layer of steel wire
- Cover: V00 = Polyurethane, V30 = Polyamide

Fittings

- 43 Series - Fittings available from Parker Hose Products Division
- For most Parker products, Crimp Die Selection charts are found online at www.parker.com/crimpsource
- Access instructions are on pg. G-3

Operating Parameters

- Temperature Range:
 - Petroleum or synthetic hydraulic fluids -40°F (-40°C) to 212°F (100°C)
- Change in length at Max. Working Pressure: +2% to -4%
- Min. Burst Pressure is 4x Max. Working Pressure at 73°F (23°C)

Notes

- Non-perforated cover

Series 2245N

[Visit the webpage](#)

| Part Number | Nominal I.D. | | Maximum O.D. | | Maximum Working Pressure | | Minimum Bend Radius | | Weight | | Permanent Fitting Series |
|-------------|--------------|------|--------------|------|--------------------------|------|---------------------|-----|----------|--------|--------------------------|
| | inch | mm | inch | mm | psi | MPa | inch | mm | lbs./ft. | kg/mtr | |
| 2245N-04V00 | 1/4 | 6.3 | .50 | 12.6 | 6,525 | 45.0 | 2-3/4 | 70 | 0.17 | 0.25 | 43 |
| 2245N-06V30 | 3/8 | 10 | .67 | 17.0 | 5,440 | 37.5 | 4-3/4 | 120 | 0.28 | 0.42 | 43 |
| 2245N-08V00 | 1/2 | 12.5 | .82 | 21.0 | 5,075 | 35.0 | 6-1/2 | 165 | 0.35 | 0.52 | 43 |
| 2245N-10V30 | 5/8 | 16 | .97 | 24.7 | 4,785 | 33.0 | 7-7/8 | 200 | 0.48 | 0.72 | 43 |
| 2245N-12V30 | 3/4 | 19 | 1.13 | 28.5 | 4,350 | 30.0 | 9-1/2 | 240 | 0.62 | 0.92 | 43 |



WARNING

This product can expose you to chemicals including Antimony Oxide (Antimony Trioxide), which is known to the State of California to cause cancer, and 2-Imidazolidinethione, which is known to the State of California to cause birth defects or other reproductive harm. For more information go to www.P65Warnings.ca.gov

Metal Hose

9A, 9M, 9P

Operates up to 1200°F (648°C).



Features

- Hydroformed or crimp formed annular core tube
- High percentage braid coverage for better life cycle and protection against core damage
- 9A - General Purpose - up to 2,700 psi working pressures
- 9M - Ultra Flexible - Compressed corrugations for increased flexibility, up to 2,700 psi working pressure
- 9P - High Pressure - up to 6,000 psi working pressure, Parker's highest pressure metal hose construction

Construction

- Tube: 300 series SS
- Reinforcement: 300 series SS braid: 0, 1 or 2 layers

Operating Parameters

- Temperature Range:
-380°F (-228°C) to 1200°F (648°C)

See **CATALOG 4690MH**
for technical information

Typical Applications

- Abrasion and over bending – as a protective cover over wires or other hoses to prevent these problems
- Chemical transfer
- Diesel engine exhaust
- Hot oil and lube lines
- Loading/unloading of light oils, gas, and chemicals
- Petrochemical
- Power Gen
 - Connections for the fuel rail to the combustion cans on gas turbine fuel lines
 - Pump connections
- Pulp & Paper
- Solvent and steam lines

- For technical information, download CAT 4690



WARNING

This product can expose you to chemicals including Lead, which is known to the State of California to cause cancer and birth defects or other reproductive harm. For more information go to www.P65Warnings.ca.gov.

Multitube[®] Hoses

BOP Bundles, Electro-Hydraulic Umbilicals and Hotlines

Over 750,000 feet of bundles in service.
Over 40 million feet of pilot hose produced.



Features

- Dependability and Experience - Over 30 years of Oil & Gas thermoplastic hose design and engineering experience
- Field Tested - Over 750,000 feet of bundles and over 40 million feet of pilot hose produced for rigs
- Capabilities - BOP umbilical lengths up to 7,000+ ft and 90+ pilot hoses within one umbilical
- Extended Service Life - Compact pilot hose design allows for more spares to be installed in the bundle without increasing the O.D.

For technical information,
contact customer services.



BOP Umbilicals with Velocity Hose

- BOP umbilicals are used on offshore drilling rigs to control the subsea BOP stack
- Parker's BOP have a smaller O.D. which means Parker can produce BOP umbilicals with more pilot lines without increasing the O.D. of the umbilical
- Parker umbilicals are built with Velocity Hose to allow for precise control and faster response times when activating subsea valves on the BOP pod



Electro-Hydraulic Umbilicals

- Parker is an industry leader in designing short length electro-hydraulic umbilicals for offshore applications
- Parker high-pressure subsea hoses, (1/4", 3/8" and 1/2" I.D.), are in compliance to API 17e and pressure ratings up to 15,000 psi. These hoses can be combined into an umbilical configuration with electrical power cables included



Hotline Hose

- Subsea Hotline's are the primary emergency hydraulic control line providing critical service for various subsea functions
- Parker Hotline hoses are specially designed to provide fast response time and low volumetric expansion with length capability of 14,000 feet continuous

WARNING

This product can expose you to chemicals including Tetrafluoroethylene, which is known to the State of California to cause cancer. For more information go to www.P65Warnings.ca.gov.



TUBING

Nylon
Polyethylene

Polypropylene
Polyurethane

Vinyl
PTFE

FEP
PFA

Table of Contents

INTRO

| | |
|--------------------------------------|------|
| Material Property Overview..... | B-4 |
| Materials to Parflex Tubing | B-10 |
| Media to Plastic Compatibility | B-11 |

| | |
|----------------------------------|-----|
| Tubing Compatibility Chart | B-8 |
| Tubing Specifications | B-6 |
| Tubing Pressures | B-7 |

| | |
|---------------------------|------|
| NOMENCLATURE | B-14 |
|---------------------------|------|

THERMOPLASTICS

NYLON TUBING

| | |
|----------------------------------|------|
| Series N/NB - Flexible | B-27 |
| PAT - Pure Air..... | B-31 |
| Series NR/NBR - Semi-Rigid | B-33 |

MULTITUBE PLASTIC BUNDLES

| | |
|----------------------|------|
| Series PJ, PJH | B-79 |
|----------------------|------|

POLYETHYLENE TUBING

| | |
|--------------------------------------|------|
| Series E/EB - Instrument Grade | B-20 |
| PEFR - Flame Resistant..... | B-23 |
| HDPE - High Density OBSOLETE..... | B-25 |

POLYPROPYLENE TUBING

| | |
|-----------------------------------|------|
| Series PP - Laboratory Grade..... | B-35 |
|-----------------------------------|------|

POLYURETHANE TUBING

| | |
|--------------------------------|------|
| 95U/95UM Polyether Based | B-37 |
| 95FR Flame Resistant..... | B-39 |

POLYVINYL CHLORIDE (VINYL) TUBING

| | |
|----------------------------------|------|
| PV Tubing Instrument Grade | B-41 |
|----------------------------------|------|

Table of Contents

FLUOROPOLYMERS

SMOOTHBORE TUBING

| | |
|-------------|------|
| PTFE..... | B-44 |
| FEP..... | B-66 |
| PFA..... | B-76 |
| HP PFA..... | B-76 |

BEADING

| | |
|-------------------|------|
| PTFE Beading..... | B-52 |
|-------------------|------|

HEAT SHRINKABLE TUBING

| | |
|---------------------------------|------|
| PTFE 2:1 Fractional..... | B-56 |
| PTFE 2:1 AWG..... | B-58 |
| PTFE 4:1 Fractional..... | B-61 |
| FEP 1.25/1 Roll Cover..... | B-70 |
| FEP 1.3/1 AWG & Fractional..... | B-68 |
| FEP 1.67/1..... | B-68 |

SPIRAL WRAP TUBING

| | |
|-----------------------|------|
| PTFE Spiral Wrap..... | B-54 |
|-----------------------|------|

CONVOLUTED TUBING

| | |
|------------------------------|------|
| PTFE Standard Convolute..... | B-62 |
| PTFE Low Profile..... | B-63 |
| PTFE Heavy Wall..... | B-63 |
| FEP Convolute..... | B-72 |
| AMS-T-81914/1 or 2..... | B-64 |
| AMS-T-81914/3 or 4..... | B-65 |

CORRUGATED TUBING

| | |
|------------------------|------|
| Corrugated Tubing..... | B-74 |
|------------------------|------|



A Hose

B Tubing Thermoplastic

C Coiled Air Hose & Fittings

D Transportation

E Fittings

F Tooling, Equipment & Accessories

G General Technical

Material Property Overview

A Hose

Thermoplastic Quick Reference

PE (Polyethylene)

Working Temperature: 150°F (66°C)

Series E/EB

- Chemical resistant
- Economical system solution
- FDA/NSF Compliant
- Resistant to environmental stress cracking

Series PEFR

- Flame resistant
- High strength & excellent flexibility
- Resistant to environmental stress cracking

Series HDPE

- Chemical resistant
- Economical system solution
- Improved burst pressure rating than LLDPE resin
- Working Temperature 175°F (80°C)

Nylon

Working Temperature: 200°F (93°C)

Series N/NB

- Abrasion resistant
- Flexible
- Heat and light stabilized
- Low moisture absorption
- Chemical resistant

Series PAT

- Chemical resistant
- UV light resistant
- Low moisture absorption
- High tensile strength

Series NR/NBR

- Unplasticized nylon for higher pressure tubing applications
- Chemical resistant
- Low moisture absorption
- High tensile strength

PP (Polypropylene)

Working Temperature: 200°F (93°C)

Series PP/PPB

- Acid & chemical resistant
- Low moisture absorption (less than .01%)
- Resistant to environmental stress cracking
- Higher working pressures/temperatures than PE tubing

PU (Polyurethane)

Working Temperature: 180°F (82°C)

Series 95U/95UM

- 95 Shore A durometer
- Excellent abrasion and kink resistance
- Excellent moisture resistance
- UV resistant
- Exhibits the elongation and recovery characteristics of rubber and the chemical resistance of a thermoplastic

Series 95FR

- 95 Shore A durometer
- Weld spatter resistant
- Flame & weld spatter resistant
- Silicone and halogen free
- Excellent flexibility
- Working Temperature 165°F (75°C)

Tubing Thermoplastic

Coiled Air Hose & Fittings

D Transportation

F Fittings

Tooling, Equipment, & Accessories

G General Technical

Tubing specifications are located on page B-6

Material Property Overview

Fluoropolymer Quick Reference

PTFE (Polytetrafluoroethylene)

Working Temperature: 500°F (260°C)

Color: Opaque to translucent

- Chemically inert
- Lowest coefficient of friction
- Superior dielectric strength
- Exceptional heat resistance
- Self extinguishing
- Non-wetting
- Excellent flexlife
- Laser markable

PFA (Perfluoroalkoxy)

Working Temperature: 500°F (260°C)

Color: Clear with light blue or tint

- High purity resins available
- Low permeation resins available
- Use when you need the temperature range of PTFE and the clarity of PFA
- Exceptional heat resistance
- Self extinguishing
- Non-wetting
- Good flexlife

FEP (Fluorinated Ethylene Propylene)

Working Temperature: 400°F (204°C)

Color: Clear

- Excellent chemical resistance
- Non-wetting
- Weldable
- Tubes can be sealed by melting
- Long continuous lengths
- Low refractive index
- Improved clarity over PFA
- Lower cost alternative to PFA

Fluoropolymer Chemical Resistance Summary



Within normal use, temperatures, fluoropolymers are attacked by so few chemicals that it is easier to describe the exceptions rather than list the chemicals they are compatible with.

DO NOT USE FLUOROPLASTICS WITH THE FOLLOWING:

- Alkali metals such as elemental sodium, potassium, lithium, etc. The alkali metals remove fluorine from the polymer molecule.
- Extremely potent oxidizers, fluorine (F₂) and related compounds (e.g., chlorine trifluoride, ClF₃). These can be handled by fluoropolymers, but only with great care, as fluorine is absorbed into the resins, and the mixture becomes sensitive to a source of ignition such as impact.
- 80% NaOH (Sodium Hydroxide) or KOH (Potassium Hydroxide), metal hydrides such as Boranes (e.g., B₂H₆), Aluminum Chloride, Ammonia (NH₃), certain Amines (R-NH₂) and imines (R=NH) and 70% Nitric Acid at temperatures near the suggested service limit.



WARNING

FAILURE OR IMPROPER SELECTION OR IMPROPER USE OF THE PRODUCTS AND/OR SYSTEMS DESCRIBED HEREIN OR RELATED ITEMS CAN CAUSE DEATH, PERSONAL INJURY AND PROPERTY DAMAGE.

This document and other information from Parker Hannifin Corporation, its subsidiaries and authorized distributors provide product and/or system options for further investigation by users having technical expertise. It is important that you analyze all aspects of your application and review the information concerning the product or system in the current product catalog. Due to the variety of operating conditions and applications for these products or systems, the user, through its own analysis and testing, is solely responsible for making the final selection of the products and systems and assuring that all performance, safety and warning requirements of the application are met.

The products described herein, including without limitation, product features, specifications, designs, availability and pricing, are subject to change by Parker Hannifin Corporation and its subsidiaries at any time without notice.

Tubing specifications are located on page B-6

A
Hose

B
Tubing
Thermoplastic

C
Coiled Air Hose
& Fittings

D
Transportation

E
Fittings

F
Tooling, Equipment
& Accessories

G
General Technical

Tubing Specifications

A Hose

B Tubing Thermoplastic

C Coiled Air Hose & Fittings

D Transportation

E Fittings

F Tooling, Equipment, & Accessories

G General Technical

| Agency Specifications | Tubing Series |
|---|--|
| Flame Resistance | |
| UL 94 V-0 | PFA, FEP and PTFE tubing, 95FR Cover |
| UL 94 V-2 | PEFR |
| UL 94 HB | 83FR, NN, NB, NNR, NBR (wall thickness above .033" - contact Parflex for availability) |
| Food Contact | |
| FDA, CFR21 Part 177 | E, PP, PV, All natural and black PFA, FEP and PTFE tubing products |
| NSF Standard 51* | E, PP |
| Potable Water | |
| NSF Standard 61* | E - Tubing |
| Aerospace Military Specifications | |
| AMS 3584A | HS2TFI |
| AMS 3585 | HS2TFT |
| AMS 3586 | HS2TFS |
| AMS 3653G | TFS, TFL, TFH, TFT |
| AMS 3655B | TFT |
| MIL-DTL-27267C | PTFE Conductive Tubing |
| AS81914/1 | 81914/1 Dimensionally compliant only |
| AS81914/2 | 81914/2 Dimensionally compliant only |
| AS81914/3 | 81914/3 Dimensionally compliant only |
| AS81914/4 | 81914/4 Dimensionally compliant only |
| American Society for Testing and Materials | |
| ASTM D2116-07 | 103, 203 |
| ASTM D2902 TYPE I | HS2TFS, HS2TFT, HS2TFL, HS2TFI, HS2TFH |
| ASTM D2902 TYPE II | HS1.3FEP, HS1.6FEP, HS1.25FEP |
| ASTM D3295 | TSWTF |
| ASTM D3295, Class 1 | TFL |
| ASTM D3295, Class 2 | TFT |
| ASTM D3295, Class 3 | TFS |
| ASTM D3295, Class 4 | TFH |
| ASTM D3296-03 | HS1.3FEP, HS1.6FEP, CV (FEP), 81914/3, 81914/4, CR (FEP), 703 |
| ASTM D3307-10 | 104, 204, 105, 205, CR (PFA), 704, 705 |
| Canadian Standards Association | |
| CSA 9032-01 300V | TFT (awg) |
| CSA 9032-01 600V | TFS (awg) |
| United States Pharmacopeia | |
| USP Class VI | 101, 201, TFS, TFL, TFH, TFT, HS2TFS, HS2TFT, HS2TFL, HS2TFI, HS2TFH, CV, CVL, CVH, 103, 203, HS1.3FEP, HS1.6FEP, CR, 104, 204, 105, 205 |

Tubing Pressures Ranges

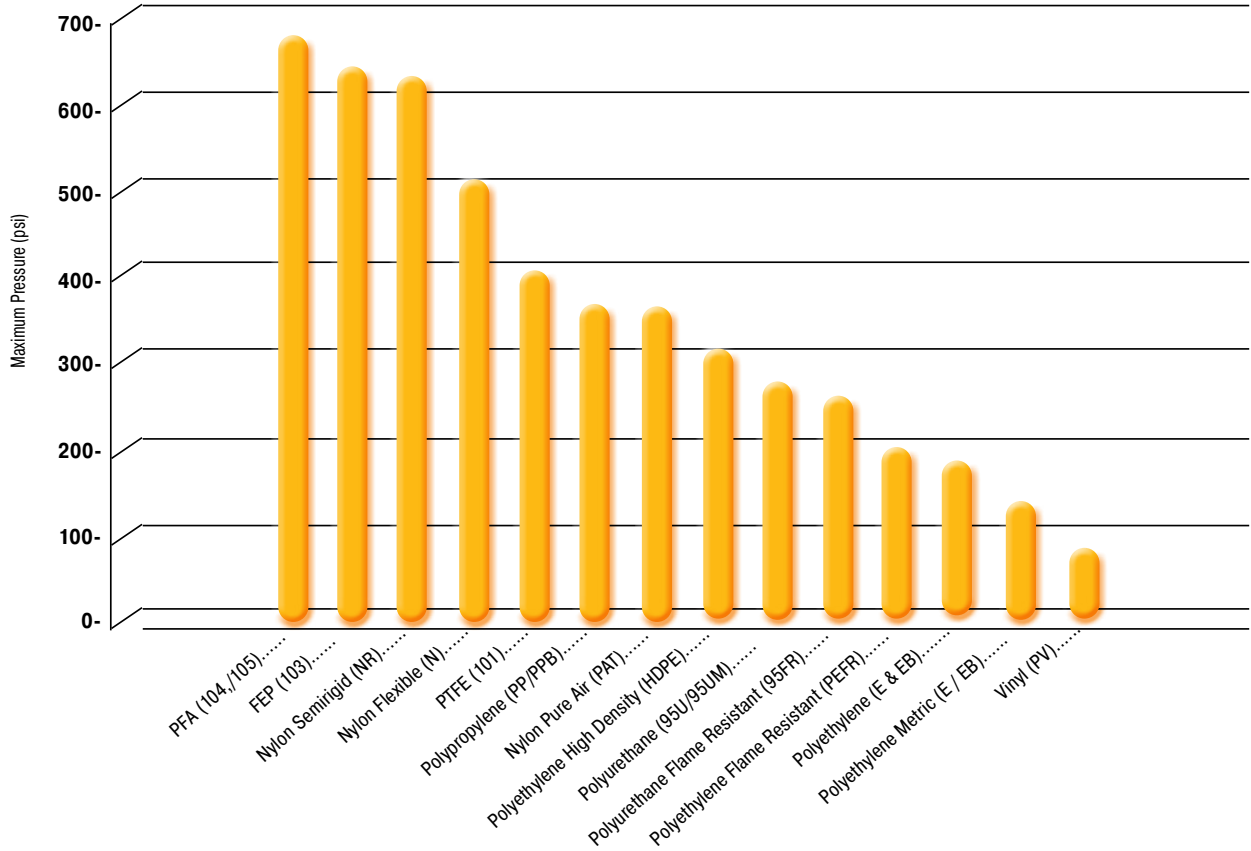

A Hose

B Tubing Thermoplastic

C Coiled Air Hose & Fittings

D Transportation

E Fittings

F Tooling, Equipment & Accessories

G General Technical

Tubing Compatibility Chart

Tubing/Hose Capability with Parker FSC Fittings

A Hose
B Tubing Thermoplastic
C Coiled Air Hose & Fittings
D Transportation
E Fittings
F Tooling, Equipment, & Accessories
G General Technical

| Product Sizes (inch) | | Thermoplastic and Thermo-elastomer Tubing | | | | | | | | | |
|------------------------------------|--|--|---------------------------------------|---------------------------------|-----------------------------------|---------------------------------|------------------------------------|--|---|--|-------------------------------------|
| | | Industrial Tubing Series (Outside Diameter (O.D.) Shown) | | | | | | | | | |
| | | Polyethylene E & EB Inch (4.5,6.8, 10) Metric (6.8, 10, 12) | Polyethylene PEFR Inch (2.5,4,6,8) | Polyethylene HDPE Inch (4,6) | Nylon N Inch (2.2-5.3,4,5,6,8) | Nylon PAT Inch (2,4,6,8, 12) | Nylon NP/NBR Inch (2,3,4,5,6,8) | Polypropylene PP & PPB Inch (2,3,4,6,8, 10) | Polyurethane 95U & 95UM (90 - 95 Shore A) Inch (2,2.5,4,6,8, 12) Metric (4,6,8,10, 12) | Polyurethane MicroMeld™ 95FR Inch (4,6,8) Metric (6,8,10, 12) | Clear Vinyl Inch (1/8" - 2 1/2") |
| Compression & Flare | Compression Inch (2,3,4,5,6, 7,8, 10, 12) | PS TS | PS TS | PS TS | PS TS | PS TS | PS TS | PS TS | | | |
| | Compress-Align Inch (2,3,4,5,6,8, 10, 12, 14, 16) | TS | TS | TS | TS | TS | TS | TS | | | |
| | Metric Compression Metric (4,5,6,8, 10, 12, 14, 16, 18, 20, 22, 25, 28) | TS | | | TS | | TS | TS | TS | | |
| | Poly-Tite Inch (4,5,6,8) | | | | BS | | | BS | | | |
| | Hi-Duty Inch (2,3,4,5,6,8, 10) | TS | TS | TS | TS | TS | TS | TS | | | |
| | 45 degree flare Inch (2,3,4,5,6,8, 10, 12, 14) | | | | | | | | | | |
| | Inverted Flare Inch (2,3,4,5,6,8, 10, 12) | | | | | | | | | | |
| | Fast & Tite Inch (4,5,6,8, 10) | | | | | | | | TS | | TS |
| Push-to-Connect | Flow Controls Inch (2,2.5,4,5,6,8) Metric (4,6,8, 10, 12) | | | | | | | | TS | | |
| | Prestolok PLP Metal Inch (2,2.5,3,4,5,6,8) | | | | | | | | | | |
| | Prestolok PLP Composite Inch (2,2.5,3,4,5,6,8, 10) Metric (3,4,6,8, 10, 12, 14, 16) | | | | | | | | TS | | |
| | Prestolok PLM Metal Inch (2.5,4,5,6,8) Metric (4,6,8, 10, 12, 14) | | | | | | | | | | |
| | Prestolok PLS Stainless Steel Inch (2.5,3,4,5,6,8) Metric (4,6,8, 10, 12) | | | | | | | | | | |
| | Liquifit Inch (2.5,4,6,8) Metric (4,6,8, 10, 12) | | | | | | | | | | |
| | TrueSeal Inch (4,5,6,8) | | | | | | MG | MG | TS | | TS |
| Barb | Par-Barb Inch (2,3,4,5,6,8, 10, 12, 16, 20, 24) Inside Diameter | | | | | | | | | | CL |
| | Dubl-Barb Inch (2.5,4,6,8) | | | | | | | | | | |
| | Hose Barb Inch (2,3,4,5,6,8, 10, 12, 16) Inside Diameter Garden Hose | | | | | | | | | | CL CL |
| DOT Transportation | NTA Inch (3,4,6,8, 10, 12) | | | | | | | | | | |
| | Transmission Fittings Inch (2,2.5) | | | | | | | | | | |
| | Air Brake Inch (4,6,8, 10, 12, 16) | | | | | | | | | | |
| | Air Brake Hose Inch (6,8) | | | | | | | | | | |
| | Vibra-Lok Inch (2,3,4,5,6,8, 10, 12) | | | | | | | | | | |
| | Prestomatic Inch (4,6,8, 10) Metric (6,8, 10, 12, 16) | | | | | | | | | | |
| | PTC Inch (2.5,3,4,6,8, 10, 12) | | | | | | | | | | |
| SAE Cartridges Inch (4,6,8, 10) | | | | | | | | | | | |

Tubing Compatibility Chart for Fittings

Tubing/Hose Capability with Parker FSC Fittings

Hose
A

Tubing Thermoplastic
B

Coiled Air Hose & Fittings
C

Transportation
D

Fittings
E

Tooling, Equipment & Accessories
F

General Technical
G

Thermoplastic Tubing

Fluoropolymer Tubing

| Transportation Tubing | | | |
|--|--|--|---|
| PFT Air Brake (SAE J844) Inch (2, 2.5, 3, 4, 5, 6, 8, 10, 12) | Air Brake DIN 74324 (Nylon 12) Metric (4, 6, 8, 10, 12, 15, 16, 18) | PFT Diesel Fuel Sizes 4, 6, 8, 10, 12 | HTFL Diesel Fuel Sizes 4, 6, 8, 10, 12 |

Tube Line Fabrication Guide for Leak Free Systems

Every hydraulic, pneumatic and lubrication system requires some form of tube line fabrication and fitting installation for completion. Proper fabrication and installation are essential for the overall efficiency, leak free performance, and general appearance of any system. Start by planning ahead. After sizing the tube lines and selecting the appropriate style of fitting, consider the following in the design of your system:

1. Accessibility of joints
2. Proper routing of lines
3. Adequate tube line supports
4. Available fabricating tools

Product Sizes (inch)

| Thermoplastic Tubing | Fluoropolymer Tubing | Product Sizes (inch) | Compatibility |
|----------------------|----------------------|---|---------------|
| | PS | Compression Inch (2, 3, 4, 5, 6, 7, 8, 10, 12) | PS |
| | TS | Compress-Align Inch (2, 3, 4, 5, 6, 8, 10, 12, 14, 16) | TS |
| | TS | Metric Compression Metric (4, 5, 6, 8, 10, 12, 14, 16, 18, 20, 22, 25, 28) | TS |
| | | Poly-Tite Inch (4, 5, 6, 8) | |
| | | Hi-Duty Inch (2, 3, 4, 5, 6, 8, 10) | |
| | | 45 degree flare Inch (2, 3, 4, 5, 6, 8, 10, 12, 14) | |
| | | Inverted Flare Inch (2, 3, 4, 5, 6, 8, 10, 12) | |
| | | Fast & Tite Inch (4, 5, 6, 8, 10) | |
| | | Flow Controls Inch (2, 2.5, 4, 5, 6, 8) Metric (4, 6, 8, 10, 12) | |
| | | Prestolok PLP Metal Inch (2, 2.5, 3, 4, 5, 6, 8) | |
| | | Prestolok PLP Composite Inch (2, 2.5, 3, 4, 5, 6, 8, 10) Metric (3, 4, 6, 8, 10, 12, 14, 16) | |
| | | Prestolok PLM Metal Inch (2.5, 4, 5, 6, 8) Metric (4, 6, 8, 10, 12, 14) | |
| | | Prestolok PLS Stainless Steel Inch (2.5, 3, 4, 5, 6, 8) Metric (4, 6, 8, 10, 12) | |
| | | Liquifit Inch (2.5, 4, 6, 8) Metric (4, 6, 8, 10, 12) | |
| | MG | TrueSeal Inch (4, 5, 6, 8) | MG |
| | | Par-Barb Inch (2, 3, 4, 5, 6, 8, 10, 12, 16, 20, 24) Inside Dia. | |
| | | Dubl-Barb Inch (2.5, 4, 6, 8) | |
| | | Hose Barb Inch (2, 3, 4, 5, 6, 8, 10, 12, 16) Inside Diameter Garden Hose | |
| | | NTA Inch (3, 4, 6, 8, 10, 12) | |
| | | Transmission Fittings Inch (2, 2.5) | |
| | | Air Brake Inch (4, 6, 8, 10, 12, 16) | |
| | | Air Brake Hose Inch (6, 8) | |
| | | Vibra-Lok Inch (2, 3, 4, 5, 6, 8, 10, 12) | |
| | | Prestomatic Inch (4, 6, 8, 10) Metric (6, 8, 10, 12, 16) | |
| | | PTC Inch (2.5, 3, 4, 6, 8, 10, 12) | |
| | | SAE Cartridges Inch (4, 6, 8, 10) | |

PS Plastic Sleeve & Tube Support Recommended

TS Tube Support Is Recommended

BS Brass Sleeve Recommended

CL Clamp Required

MG Metal Gripper Collet Recommended

PS Tube/Fitting Combination Compatible

□ Tube/Fitting Combination NOT Compatible

For technical information, download FSC CAT 3501



Materials to Parflex Tubing

A Hose

Materials to Parflex Thermoplastic Tubing

| Material Code for Hose Core Tubes | Material Name | Hose |
|-----------------------------------|-----------------------------------|----------------------|
| HDPE | High Density Polyethylene | HDPE |
| N | Flexible Nylon | N |
| NR | Unplasticized Nylon (semi-rigid) | NR |
| PE | Linear Low Density Polyethylene | E |
| PEFR | Flame Resistant Polyethylene | PEFR |
| PP | Polypropylene | PP |
| PV | Flexible Polyvinyl Chloride (PVC) | PV |
| U | Polyurethane | 95U/95UM, 95FR/95FRM |

Materials to Parflex Fluoropolymer Tubing

| Material Code for Hose Core Tubes | Material Name | Hose |
|-----------------------------------|--------------------------------|--|
| FEP | Fluorinated Ethylene Propylene | 103, 203, HS1.3FEP, HS1.6FEP, CV03, CR03, 81914/3, 81914/4 |
| PFA | Perfluoroalkoxy | 104, 204, 105, 205, CV04, CR04, 704, 705 |
| PTFE | Polytetrafluoroethylene | AWG TFL, AWG TFS, AWG TFT, AWG TFH, 101, 201, HS2TFS, HS2TFT, HS2TFL, HS2TFI, HS4TFI, CV01, CVL, CVH, 81914/1, 81914/2 |

Rating Codes:

- G Good to excellent. Little or no swelling, tensile or surface changes. Preferred choice.
- L Marginal or conditional. Noticeable effects but not necessarily indicating lack of serviceability. Further testing suggested for specific application. Very long-term effects such as stiffening or potential for crazing should be evaluated.
- P Poor or unsatisfactory. Not recommended without extensive and realistic testing.
- – Indicates that this was not tested.
- # For fluoropolymer. Indicates good chemical resistance but potential for excessive permeation.
- 2 See notes pg. B-13.
- 5 See notes pg. B-13.
- 6 See notes pg. B-13.

Tubing Thermoplastic

Coiled Air Hose & Fittings

D Transportation

F Fittings

Tooling, Equipment, & Accessories

G General Technical

Media to Plastic Tubing Material Compatibility Guide

A
Hose

Media to Plastic Tubing Material

| Media | PE | HDPE | PP | N | NR | PV | U | PEFR | FEP | PFA | PTFE |
|-----------------------|----|------|----|---|----|----|---|------|-----|-----|------|
| Acetone | P | L | G | G | G | P | P | L | G | G | G |
| Acetyl Bromide | L | L | L | P | P | P | - | - | - | - | - |
| Acetyl Chloride | L | L | L | P | P | P | - | - | G | G | G |
| Air | G | G | G | G | G | G | G | G | G | G | G |
| Alcohols | G | G | G | G | G | L | L | G | G | G | G |
| Aluminum Salts | G | G | G | G | G | G | G | G | - | - | - |
| Ammonia | G | G | G | G | G | G | G | L | - | - | - |
| Amyl Acetate | G | G | G | G | G | P | L | - | G | G | G |
| Aniline | L | G | L | P | P | P | P | - | G | G | G |
| Animal Oils (6) | P | L | L | G | G | G | G | - | - | - | G |
| Arsenic Salts | G | G | G | G | G | G | G | G | - | - | - |
| Aromatic Hydrocarbons | P | L | L | G | G | P | L | P | - | - | G |
| Barium Salts | G | G | G | G | G | G | G | G | - | - | - |
| Benzaldehyde | P | L | L | L | L | P | L | P | G | G | G |
| Benzene | P | L | L | G | G | P | L | P | G | G | G |
| Benzyl Alcohol | P | G | L | L | L | G | L | P | G | G | G |
| Bleaching Liquors | G | L | G | L | L | L | L | - | - | - | - |
| Boric Acid Solutions | G | G | G | G | G | G | G | G | G | G | G |
| Bromine | L | L | P | P | P | P | P | - | G | L | G |
| Butane (2) | L | G | G | G | G | L | P | - | # | # | # |
| Butanol | G | G | G | G | G | G | G | G | - | - | - |
| Butyl Acetate | G | G | L | G | G | P | L | G | G | G | G |
| Calcium Hypochlorite | L | L | P | P | L | L | P | L | G | G | G |
| Calcium Salts | G | G | G | G | G | G | G | G | - | - | - |
| Carbon Dioxide | G | G | G | G | G | G | G | G | # | # | # |
| Carbon Disulfide | L | L | L | L | L | P | L | - | # | # | # |
| Carbon Tetrachloride | P | P | L | L | L | L | P | P | G | G | G |
| Caustic Potash | G | G | G | G | G | L | G | - | G | G | G |
| Caustic Soda | G | G | G | G | G | L | G | - | G | L | G |
| Chloroacetic Acid | L | G | L | L | L | P | P | - | G | L | G |
| Chlorine (Dry) | L | L | L | P | P | G | P | - | # | # | # |
| Chlorine (Wet) | L | L | L | P | P | G | L | - | G | G | G |
| Chlorobenzene | P | L | L | L | L | P | L | P | G | G | G |
| Chloroform | P | L | P | P | P | P | P | P | G | G | G |
| Chromic Acid | L | L | L | P | P | G | P | - | L | G | G |
| Copper Salts | G | G | G | G | G | G | G | G | - | - | - |
| Cresol | P | L | L | P | P | L | P | P | G | G | G |
| Cyclohexanone | L | L | L | L | L | P | P | - | G | G | G |
| Ethers | L | L | P | G | G | L | P | - | G | G | G |
| Ethyl Acetate | G | G | G | G | G | P | L | - | G | G | G |
| Ethyl Alcohol | G | G | G | L | L | L | G | G | - | - | - |
| Ethylamine | L | G | L | L | L | P | L | - | - | - | - |
| Ethyl Bromide | P | L | L | L | L | P | - | P | - | - | - |
| Ethyl Chloride | P | L | P | L | L | P | - | P | G | G | G |
| Fatty Acids | L | L | L | G | G | L | L | P | G | G | G |

Rating Code - pg. B-10 Notes - pg. B-13 (Cont.)

B
Tubing
Thermoplastic

C
Coiled Air Hose
& Fittings

D
Transportation

E
Fittings

F
Tooling, Equipment
& Accessories

G
General Technical

Media to Plastic Tubing Material Compatibility Guide

A Hose

Media to Plastic Tubing Material

| Media | PE | HDPE | PP | N | NR | PV | U | PEFR | FEP | PFA | PTFE |
|---------------------------------|----|------|----|---|----|----|---|------|-----|-----|------|
| Ferric Salts | G | G | G | G | G | G | G | - | - | - | - |
| Formaldehyde | G | G | G | L | L | L | P | - | G | G | G |
| Formic Acid | G | G | G | P | P | G | P | G | G | G | G |
| Freon | L | L | L | G | G | P | L | - | # | # | # |
| Gasoline (2) | P | G | L | G | G | P | L | P | G | G | G |
| Glucose | G | G | G | G | G | G | G | G | G | G | G |
| Glycerin | G | G | G | G | G | G | L | G | G | G | G |
| Hydriodic Acid | L | G | G | P | P | G | - | - | - | - | - |
| Hydrochloric Acid. (Conc.) | L | G | G | L | L | L | P | - | G | L | G |
| Hydrochloric Acid. (Med. Conc.) | L | G | G | L | L | L | P | - | G | L | G |
| Hydrofluoric Acid | L | L | G | P | P | L | P | - | G | - | G |
| Hydrogen Peroxide (Conc.) | L | G | L | L | L | L | G | - | - | - | - |
| Hydrogen Peroxide (Dil.) | L | G | L | G | G | G | G | - | - | - | - |
| Hydrogen Sulfide | G | G | G | G | G | G | P | - | G | G | G |
| Iodine | L | G | G | G | G | L | L | - | G | G | G |
| Kerosene (2) | L | L | L | G | G | L | L | - | G | G | G |
| Ketones | G | G | G | G | G | P | P | - | G | G | G |
| Lacquer Solvents | L | L | L | G | G | P | - | - | L | G | G |
| Lactic Acid | G | G | G | G | G | G | G | - | G | G | G |
| Lead Acetate | G | G | G | G | G | G | G | - | G | G | G |
| Linseed Oil | L | G | G | G | G | L | G | - | G | G | G |
| Magnesium Salts | G | G | G | G | G | G | G | - | - | - | G |
| Naphtha | L | L | L | G | G | P | L | G | G | G | G |
| Natural Gas | L | L | L | G | G | G | G | - | (2) | (2) | (2) |
| Nickel Salts | G | G | G | G | G | G | G | - | - | - | - |
| Nitric Acid (Conc.) | P | L | P | P | P | L | P | G | L | L | G |
| Nitric Acid (Dil.) | P | G | L | L | L | G | P | P | L | L | G |
| Nitrobenzene | P | L | G | L | L | P | P | P | G | G | G |
| Nitrogen Oxides | L | L | G | L | L | G | - | - | - | - | - |
| Nitrous Acid | L | L | G | L | L | G | L | - | G | G | G |
| Oils (Animal and Mineral) | L | L | L | G | G | L | G | - | G | G | G |
| Oils (Vegetable) | L | L | L | G | G | L | G | - | G | G | G |
| Oxygen (5) (6) | G | G | G | G | G | G | G | G | G | G | G |
| Perchloric Acid | P | G | L | P | P | L | P | P | L | G | G |
| Phenols | P | G | G | P | P | L | P | P | - | - | G |
| Potassium Salts | G | G | G | G | G | G | G | G | - | - | - |
| Pyridine | L | L | L | L | L | P | P | - | G | G | G |
| Silver Nitrate | G | G | G | G | G | G | G | G | G | G | G |
| Soap Solutions | G | G | G | G | G | G | G | G | G | G | G |
| Sodium Salts | G | G | G | G | G | G | G | G | - | - | - |
| Stearic Acid | L | L | L | G | G | P | L | - | G | G | G |
| Sulfur Chloride | L | L | P | L | L | L | - | - | G | G | G |
| Sulfuris Acid (Conc.) | P | G | G | P | P | L | P | P | - | - | - |
| Sulfuris Acid (Dil.) | P | G | G | L | L | G | L | P | - | - | - |
| Sulfurous Acid | P | G | L | L | L | G | L | P | G | G | G |

Rating Code - pg. B-10 Notes - pg. B-13 (Cont.)

Tubing Thermoplastic

Coiled Air Hose & Fittings

Transportation

Fittings

Tooling, Equipment, & Accessories

General Technical

Media to Plastic Tubing Material Compatibility Guide

Media to Plastic Tubing Material

| Media | PE | HDPE | PP | N | NR | PV | U | PEFR | FEP | PFA | PTFE |
|------------------------|----|------|----|---|----|----|---|------|-----|-----|------|
| Tannic Acid | G | G | G | G | G | G | P | - | G | G | G |
| Tanning Extracts | G | G | G | G | G | G | P | - | - | - | - |
| Titanium Salts | G | G | G | G | G | G | G | G | - | - | - |
| Toluene | P | L | P | G | G | P | L | P | G | G | G |
| Trichloroacetic Acid | L | L | L | P | P | P | P | - | - | - | - |
| Trichloroethylene | P | L | P | L | L | P | P | P | G | G | G |
| Turpentine | P | P | L | G | G | L | L | - | G | G | G |
| Urea | G | G | G | G | G | G | G | - | G | L | G |
| Uric Acid | G | G | G | G | G | G | G | - | G | G | G |
| Water (6) | G | G | G | G | G | G | G | G | G | G | G |
| Water / Glycol Mixture | G | G | G | G | G | G | G | G | G | G | G |
| Xylene | P | L | P | G | G | P | P | P | G | G | G |
| Zinc Chloride | G | G | G | G | G | G | G | - | G | L | G |

Rating Code - pg. B-10

Notes:

The Fluid Compatibility Guides are simplified rating tabulations based on immersion tests at 75°F. Higher temperatures tend to reduce ratings. Since final selection depends on pressure, fluid and ambient temperature and other factors not known to Parker Hannifin Co., no performance guarantee is expressed or implied. Ratings do not imply compliance with specialized codes such as FDA, NSF, AGA or UL and do not cover possible fluid discoloration, taste or odor effects. For conveying foodstuffs, use FDA sanctioned materials and for potable water, use NSF listed materials. For chemicals not listed, or for advice on particular applications, please consult Product Engineering, Parflex Div., Ravenna, Ohio,

- (2) Tubing applications for these fluids must take into account legal and insurance regulations. This does not imply AGA or UL compliance.
- (5) Chemical compatibility does not imply low permeation rates. Consult the Parker factory for a suggestion for your specific requirement.
- (6) Does not imply NSF or FDA compliance.
- Chemical compatibility does not imply acceptability for use in airless paint spray applications. These applications require a special conductive tube.

Nomenclature Thermoplastic Tubing

Nylon & Polyurethane: Series N, NR, PAT, 95U, 95UM, 95FR



| Product Family | Tube Size O.D. | Tube Wall Thickness | Tubing Color Nylon* | Tubing Color Polyurethane |
|---|----------------------|----------------------|---|---|
| Nylon | See Selection Charts | See Selection Charts | See Selection Charts | See Selection Charts |
| NN = Nylon | | | | |
| NB = Nylon, Black | Imperial | Imperial | NN = Natural | Blank = Natural |
| PAT = Nylon, Pure Air Tubing* | | Example | NB = Black | BLK = Black |
| NBR - Nylon, Semi-rigid black | 2 = .125 | 016 = .016 | BLU = Blue | BLU = Blue |
| NNR - Nylon, Semi-rigid | 2.5 = .156 | 124 = .124 | GRN = Green | GRA = Gray |
| | 3 = .188 | | RED = Red | GRN = Green |
| Polyurethane | 4 = .250 | | YEL = Yellow | RED = Red |
| 95U = Polyurethane, 95 Durometer | 5 = .313 | Metric | | WHT = White |
| 95UM = Polyurethane, 95 Durometer, Metric | 6 = .375 | Example | | YEL = Yellow |
| 95FR = Polyurethane, MicroWeld Flame Resistant | 8 = .500 | .65 = .65 mm | Note: Parflex standard color is natural | TBL = Transparent Blue |
| 95FRM = Polyurethane, MicroWeld Flame Resistant, Metric | 10 = .625 | 14 = 14 mm | | TGN = Transparent Green |
| | 12 = .750 | | | TRD = Transparent Red |
| | | | | TYL = Transparent Yellow |
| | Metric Example | | | |
| | .65 = .65 mm | | | Note: Parflex standard color is natural |
| | 14 = 14 mm | | | |

Tubing Packaging**

See Selection Charts

0100 = 100 ft coil
0250 = 250 ft coil
0500 = 500 ft coil
1000 = 1000 ft coil

*Note: PAT Tubing

Does not have a "-" between the product family and the tube O.D.
Does not have a wall thickness listed.
Has special colors not available in other series BRN = Brown, SIL = Silver, BLK = Black

**Note: Nylon Tubing

Standard 250' package has no length reference.
Contact Parflex Division for additional size/color options.

Example: N-4-035-Red

N-4-035-Red – Nylon
N-4-035-Red – Tube O.D. in sixteenths of an inch (1/4")
N-4-035-Red – Wall Thickness in inches (.035")
N-4-035-Red – Color, i.e. Red (Omit for Natural and Black)
NN-4-035-EZ - 100 ft box, Natural Nylon
NB-4-035-0100 - Black Nylon
N-4-035-Red – Package Quantity in feet (250')

Standard 250' package has no length reference.
Add -EZ for 100' boxed coil (NB-4-035-EZ)

Example: 95UM-6x1-BLK-0100

95UM-6x1-BLK-0100 – 95 Durometer Polyurethane
95UM-6x1-BLK-0100 – Tube O.D. in millimeters (6mm)
95UM-6x1-BLK-0100 – Tube I.D. in millimeters (1mm)
95UM-6x1-BLK-0100 – Color Black (Omit for Natural)
95UM-6x1-BLK-0100 – Package Quantity in feet (100')

Nomenclature Thermoplastic Tubing

Polyethylene, Polypropylene & Vinyl: Series E, EB, PEFR, HDPE, PP, PPB, PV



| Product Family | Tube Size O.D. | Tube Size I.D. | Tubing Color* | Tubing Packaging | Tubing Configuration |
|--------------------------------------|---|---|--|--|--|
| E = Polyethylene | See Selection Charts | See Selection Charts | See Selection Charts | See Selection Charts | See Selection Charts |
| EB = Polyethylene, Black | | | | | |
| PEFR = Polyethylene, Flame Resistant | Imperial | Imperial | Blank = Natural Blank = Black | Lengths | NSF = NSF Compliant (add to black part number EB) |
| HDPE = Polyethylene, High Density | 2 = .125 2.5 = .156 | 2 = .125 2.5 = .156 | B = Blue | 0100 = 100 ft coil 0250 = 250 ft coil | |
| PP = Polypropylene, White | 3 = .188 | 3 = .188 | G = Green | 0500 = 500 ft coil | |
| PPB = Polypropylene, Black | 4 = .250 | 4 = .250 | GRA = Gray | 1000 = 1000 ft coil | |
| PV = Vinyl | 5 = .313 6 = .375 8 = .500 10 = .625 | 5 = .313 6 = .375 8 = .500 10 = .625 | O = Orange P = Purple R = Red Y = Yellow WHT = White | | |
| | Metric Example | Metric Example | | | |
| | 1 = 1mm 1.5 = 1.5mm | 1 = 1mm 1.5 = 1.5mm | | | |

*Note: PEFR & HDPE Tubing only available in black.
PV tubing only available in natural color.
Contact Parflex Division for additional size/color options.

Example: E-64-Y-0500

E-64-Y-0500 – Polyethylene
E-64-Y-0500 – Tube O.D. in sixteenths of an inch (3/8")
E-64-Y-0500 – Tube I.D. in sixteenths of an inch (1/4")
E-64-Y-0500 – Color, i.e. Yellow (Omit for Natural and Black)
E-64-0500 – Natural Polyethylene
EB-64-0500 – Black Polyethylene
E-64-Y-0500 – Package Quantity in feet (500')

Example: EB-6X1-0100

EB-6X1-0100 – Polyethylene
EB-6X1-0100 – Tube O.D. in millimeters (6)
EB-6X1-0100 – Wall Thickness in millimeters (1) (Nominal I.D. 4mm)
EB-6X1-0100 – Package Quantity in feet (100')

Example: PEFR-4-0500

PEFR-4-0500 – Flame Resistant Polyethylene
PEFR-4-0500 – Tube O.D. in sixteenths of an inch (1/4")
PEFR-4-0500 – Package Quantity in feet (500')

Example: PP-86-0250

PP-86-0250 – Polypropylene
PP-86-0250 - Natural
PPB-86-0250 -Black
PP-86-0250 – Tube O.D. in sixteenths of an inch (1/2")
PP-86-0250 – Tube I.D. in sixteenths of an inch (3/8")
PP-86-0250 – Package Quantity in feet (250')

Example: PV108-1

PV108-1 – Poly-Vinyl
PV108-1 – Tube O.D. in sixteenths of an inch (5/8")
PV108-1 – Tube I.D. in sixteenths of an inch (1/2")
PV108-1 – Formula V-1 FDA Approved Formulation

Nomenclature Fluoropolymer Tubing

PTFE, FEP, PFA: Series 101/201, 103/203, 104/204, 105/205, 703/704



| Product Family | Resin Family | Tube Size O.D. | Wall Thickness | Tubing Color | Tubing Packaging |
|--|---|---|---|--|---|
| 1 = Fractional 2 = Metric 7 = Retractable Coil 9 = Custom | 01 = PTFE 03 = FEP 04 = PFA 05 = PFA High Purity | See Selection Charts Imperial Example 250 = .250 inch Metric Example 700 = 7 mm | See Selection Charts Imperial Example 062 = .062 inch Metric Example 100 = 1 mm | N = Natural 0 = Black 1 = Brown 2 = Red 3 = Orange 4 = Yellow 5 = Green 6 = Blue 7 = Violet 8 = Gray 9 = White | T = Bulk Default Configuration C = Tube Cut Job (followed by cut length in inches) |

| Tube Configuration | Tube Length |
|--------------------|--|
| Blank = No color | 25 = 25 ft coil |
| C = Solid Color | 50 = 50 ft coil |
| S = Stripe on Tube | 100 = 100 ft coil |
| L = Laser Marked | 1000 = 1000 ft coil |
| | Blank = No cut xx.xxx = Length (inch) |

Note: Parflex standard color is natural. Contact Parflex Division for additional size/color options.

Example: 101-0188062-0TC-100

- 101-0188062-0TC-100 – PTFE
- 101-0188062-0TC-100 – Tube O.D. in inches (3/16")
- 101-0188062-0TC-100 – Tube Wall Thickness in inches (.062")
- 101-0188062-0TC-100 – Black
- 101-0188062-0TC-100 – Bulk Tubing
- 101-0188062-0TC-100 – Solid Color Tube
- 101-0188062-0TC-100 – Package Quantity in feet (100')

Example: 704-0312062-xx0012

- 704-0312062-xx0012 – Retractable Tubing
- 704-0312062-xx0012 – PFA
- 704-0312062-xx0012 – Tube O.D. in inches (3/16")
- 704-0312062-xx0012 – Tube Wall Thickness in inches (.062")
- 704-0312062-xx0012 – Custom Options (when needed)
- 704-0312062-xx0012 – Length in inches (12")

Nomenclature

Fluoropolymer Extra Flexible Tubing

PTFE, FEP, PFA: Series CV, CR, 81914



| Product Family | Resin Family | Tube Size CV/CR | *Tube Size Mil-Spec | Tubing Color | Tubing Packaging | Tube Length |
|----------------------|----------------------|-----------------|---------------------|--------------|--|---|
| CV = Convoluted | 01 = PTFE | 1/8 | 2 = 1/8" | N = Natural | T = Bulk Default | Blank = No cut |
| CR = Corrugated | 03 = FEP | 3/16 | 3 = 3/16" | 0 = Black | Configuration | xx.xxx = Length (inch) |
| 81914 = AMS-T Convo* | 04 = PFA | 1/4 | 4 = 1/4" | 1 = Brown | C = Tube Cut | Cut length - has 4 decimal places for parts under 10 feet, and 5 for 10 feet and over |
| | 05 = PFA High Purity | 5/16 | 5 = 5/16" | 2 = Red | Job (followed by cut length in inches) | ie. 1200 = 12" |
| | | 3/8 | 6 = 3/8" | 3 = Orange | | ie. 12000 = 120" |
| | | 1/2 | 8 = 1/2" | 4 = Yellow | | |
| | | 5/8 | 10 = 5/8" | 5 = Green | | |
| | | 3/4 | 12 = 3/4" | 6 = Blue | | |
| | | 1 | 16 = 1" | 7 = Violet | | |
| | | 1.25 | 20 = 1-1/2" | 8 = Gray | | |
| | | 1.50 | 24 = 2-1/4" | 9 = White | | |
| | | 2.00 | 32 = 2" | | | |
| | | 2.50 | 40 = 2-1/2" | | | |
| | | 3.00 | 48 = 3" | | | |
| | | 4.00 | 64 = 4" | | | |

Example: CV01-1/8-NT

CV01-1/8-NT – Convoluted

CV01-1/8-NT – PTFE

CV01-1/8-NT – Tube O.D. in inches (1/8")

CV01-1/8-NT – Natural

CV01-1/8-NT – Bulk Tubing "T" is bulk (for cuffed tubing, remove "T" and add length, ie. CV01-1/8-NT-N1200 = 1" Convo, natural, cut 12" long)

Note: Parflex standard color is natural. Contact Parflex Division for additional size/color options.

Example: 81914/1-1010-0TC

81914/1-1010-0TC – Mil Spec Convoluted

81914/1-1010-0TC – PTFE

81914/1-1010-0TC – Helical Convolutions

81914/1-1010-0TC – Size 10 = 1"

81914/1-1010-0TC – Color 0 = Black

81914/1-1010-0TC – Bulk Tubing "T" is bulk

Example: CR01-1.00-NC29.000-2C

CR03-1.00-NC29.000-2C – Corrugated Tubing

CR03-1.00-NC29.000-2C – FEP

CR03-1.00-NC29.000-2C – Tube Size Nominal I.D. (1")

CR03-1.00-NC29.000-2C – Natural

CR03-1.00-NC29.000-2C – Cut Piece

CR03-1.00-NC29.000-2C – Overall Length in inches (29")

CR03-1.00-NC29.000-2C – Standard Cuff on each end

Nomenclature Fluoropolymer Heat Shrink

PTFE and FEP: Series HS2, HS4, HS1.3, HS1.6, HS1.25



| Product Family** | Resin Family | Special Configuration | Tube Sizes** | Tube Color |
|---------------------------|--------------|-----------------------|---|-------------|
| HS2 = 2:1 Ratio PTFE | TF = PTFE | H = Heavy Wall | XX for AWG sizes 0-30 | N = Natural |
| HS4 = 4:1 Ratio PTFE | FP = FEP | S = Standard Wall | | 0 = Black |
| HS1.3 = 1.3/1:1 Ratio FEP | PF = PFA | T = Thin Wall | | 1 = Brown |
| HS1.6 = 1.67:1 Ratio FEP | ET = ETFE | L = Light Wall | X/X for Fractional sizes 1/8 to 1.00 inch | 2 = Red |
| HS1.25 = 1.25:1 Ratio FEP | | I = Industrial Wall | | 3 = Orange |
| | | | | 4 = Yellow |
| | | | | 5 = Green |
| | | | | 6 = Blue |
| | | | | 7 = Violet |
| | | | | 8 = Gray |
| | | | | 9 = White |

| Packaging*** | Tube Configuration | Other Options |
|---|---|-----------------------------------|
| T = Bulk Default Configuration | Blank = No color C = Solid Color S = Stripe on Tube | Blank = Not required |
| C = Tube Cut Job (followed by cut length in inches) | | xx.xxx = Add cut length in inches |

Note: Parflex standard color is natural. Contact Parflex Division for additional size/color options.

Example: HS2TFS15-4TC48.000

HS2TFS15-4TC48.000 – Heat Shrink
 HS2TFS15-4TC48.000 – Shrink Ratio (2:1)
 HS2TFS15-4TC48.000 – PTFE
 HS2TFS15-4TC48.000 – Wall Type (Standard Wall)
 HS2TFS15-4TC48.000 – Heat Shrink Size in AWG (AWG15)
 HS2TFS15-4TC48.000 – Red
 HS2TFS15-4TC48.000 – Bulk Tubing
 HS2TFS15-4TC48.000 – Solid Color
 HS2TFS15-4TC48.000 – Package Quantity in inches (48")

Example: HS4TFI5/8-NC48.000

HS4TFI5/8-NC48.000 – Heat Shrink
 HS4TFI5/8-NC48.000 – Shrink Ratio (4:1)
 HS4TFI5/8-NC48.000 – PTFE
 HS4TFI5/8-NC48.000 – Wall Type (Industrial Wall)
 HS4TFI5/8-NC48.000 – Heat Shrink Size in inches (5/8")
 HS4TFI5/8-NC48.000 – Natural
 HS4TFI5/8-NC48.000 – Bulk Tubing
 HS4TFI5/8-NC48.000 – Package Quantity in inches (48")

Example: HS1.3FEP24-NT

HS1.3FEP24-NT – Heat Shrink Tubing
 HS1.3FEP24-NT – Shrink Ratio (1:3)
 HS1.3FEP24-NT – FEP
 HS1.3FEP24-NT – Heat Shrink Size in AWG (AWG24)
 HS1.3FEP24-NT – Natural
 HS1.3FEP24-NT – Bulk Tubing (Coil)

Example: HS1.6FEP3/32-NC48.000

HS1.6FEP3/32-NC48.000 – Heat Shrink Tubing
 HS1.6FEP3/32-NC48.000 – Shrink Ratio (1.67:1)
 HS1.6FEP3/32-NC48.000 – FEP
 HS1.6FEP3/32-NC48.000 – Heat Shrink Size in inches (3/32")
 HS1.6FEP3/32-NC48.000 – Natural
 HS1.6FEP3/32-NC48.000 – Cut Tubing
 HS1.6FEP3/32-NC48.000 – Cut length in inches (48")

Nomenclature

Fluoropolymer Spiral Cut Tubing and Beading

PTFE: Series TSWTF, TFB

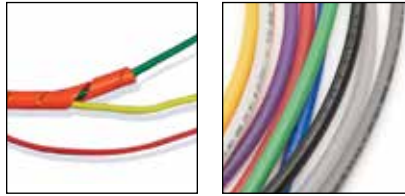

| Product Family | Resin Family | Tube O.D. | |
|----------------|--------------|-----------|------|
| TSWTF | TF = PTFE | 1/8 | 1 |
| | | 3/16 | 1.25 |
| | | 1/4 | 1.50 |
| | | 5/16 | 2.00 |
| | | 3/8 | 2.50 |
| | | 1/2 | 3.00 |
| | | 5/8 | 4.00 |
| | | 3/4 | |

| Product Family | Resin Family | Tube O.D. | | |
|----------------|--------------|-----------|-------|-------|
| TFB* | TF = PTFE | 0.015 | 0.050 | 0.090 |
| | | 0.020 | 0.055 | 0.094 |
| | | 0.025 | 0.060 | 0.100 |
| | | 0.028 | 0.062 | 0.109 |
| | | 0.031 | 0.070 | 0.115 |
| | | 0.035 | 0.072 | 0.125 |
| | | 0.039 | 0.078 | 0.150 |
| | | 0.043 | 0.080 | 0.188 |
| | | 0.047 | 0.084 | |

| Tubing Color | | Tubing Packaging | | Configuration |
|--------------|------------|-----------------------|--|---|
| N = Natural | 5 = Green | T = Bulk | C = Tube Cut | Spiral Wrap R = Right hand cut L = Left hand cut |
| 0 = Black | 6 = Blue | Default Configuration | Job (followed by cut length in inches) | |
| 1 = Brown | 7 = Violet | | | Color C = Solid Color |
| 2 = Red | 8 = Gray | | | |
| 3 = Orange | 9 = White | | | |
| 4 = Yellow | | | | |

Note: Parflex standard color is natural. Contact Parflex Division for additional size/color options.

Example: TSWTF-3/8-5TC-R

- TSWTF-3/8-5TC-R** – Spiral Wrap Tubing
- TSWTF-3/8-5TC-R** – PTFE
- TSWTF-3/8-5TC-R** – Tube O.D. in inches (3/8")
- TSWTF-3/8-5TC-R** – Green
- TSWTF-3/8-5TC-R** – Bulk Tubing
- TSWTF-3/8-5TC-R** – Solid Color
- TSWTF-3/8-5TC-R** – Right Hand Cut Spiral

Example: TFB028-NT

- TFB028-NT** – PTFE Beading
- TFB028-NT** – Beading O.D. in inches (0.028")
- TFB028-NT** – Natural
- TFB028-NT** – Bulk Tubing

Polyethylene Tubing

Series E: Instrument Grade

Series EB: Ultraviolet (UV) resistant

NSF-51, NSF-61 and FDA compliant for Food and Beverage contact.



Features

- Produced with 100% virgin resin
- Chemically resistant and flexible
- Economic system solution
- Excellent stress crack resistance

Compliance

- FDA, CFR21 Part 177 Compliant for Food Contact
- ASTM D-1693
- NSF - 51
- NSF - 61

Notes

- All tubing conforms to ASTM D-1248, Type 1, Class A, Category 4, Grade E5
- Series E natural and colored tubing meets FDA, NSF-51 requirements for food contact and NSF-61 for potable water
- Series E black (Series EB) tubing suggested for use in sunlit areas and in proximity to high UV light sources
- For FDA and/or NSF compliant black (Series EB) tubing, add -NSF to the EB part number
- Resistant to environmental stress cracking as measured by ASTM D-1693 (10% IGEPAL)
- Suggested operating temperature range is -80°F (-62°C) to 150°F (66°C) - reference Pressure vs. Temperature charts as pressures are lower at elevated temperatures
- Working pressure and burst pressure are at 73°F (23°C)

Order Information

Example: E-64-Y-0500

E-64-Y-0500 – Polyethylene

E-64-Y-0500 – Tube O.D. in sixteenths of an inch (3/8")

E-64-Y-0500 – Tube I.D. in sixteenths of an inch (1/4")

E-64-Y-0500 – Color, i.e. Yellow (Omit for Natural and Black)

E-64-0500 – Natural Polyethylene

EB-64-0500 – Black Polyethylene

E-64-Y-0500 – Package Quantity in feet (500')

Order Information

Example: EB-6X1-0100

EB-6X1-0100 – Polyethylene

EB-6X1-0100 – Tube O.D. in millimeters (6)

EB-6X1-0100 – Wall Thickness in millimeters (1) (Nominal I.D. 4mm)

EB-6X1-0100 – Package Quantity in feet (100')

Fittings

- Parker Fittings available from:
Fluid System Connectors Division
Otsego, MI
- (269) 692-6555
(269) 692-6634 FAX
parker.com/fsc
- For approved fittings and/or suggested use of tube supports, reference Tube/Fitting Compatibility Chart (pg. B-8/B-9) or contact Parker Fluid Systems Connectors Division



WARNING

This product can expose you to chemicals including Titanium dioxide, which is known to the State of California to cause cancer. For more information go to www.P65Warnings.ca.gov.

Polyethylene Tubing

Series E: Instrument Grade

Series EB: Ultraviolet (UV) resistant

Hose
A

Series E/EB - PE Fractional Size Tubing - Natural and Colors

| Part Number | Nominal O.D. | | Nominal I.D. | | Average Wall Thickness | | Working Pressure 73°F (23°C) | | Minimum Burst Pressure | | Minimum Bend Radius | | Weight | | Color |
|----------------|--------------|------|--------------|------|------------------------|-----|------------------------------|-----|------------------------|------|---------------------|-------|----------|--------|-----------------------|
| | inch | mm | inch | mm | inch | mm | psi | bar | psi | bar | inch | mm | lbs./ft. | kg/mtr | |
| E-43-X-0100 | | | | | | | | | | | | | | | ○ ● ● ● ● ● ● ● ● ● ● |
| E-43-X-0500 | | | | | | | | | | | | | | | ○ ● ● ● ● ● ● ● ● ● ● |
| E-43-X-1000 | | | | | | | | | | | | | | | ○ ● ● ● ● ● ● ● ● ● ● |
| EB-43-0100 | 1/4 | 6.4 | .170 | 4.3 | .040 | 1.0 | 120 | 8.3 | 480 | 33.1 | 1 | 25.5 | .011 | .016 | ● ● ● ● ● ● ● ● ● ● |
| EB-43-0500* | | | | | | | | | | | | | | | ● ● ● ● ● ● ● ● ● ● |
| EB-43-0500-NSF | | | | | | | | | | | | | | | ● ● ● ● ● ● ● ● ● ● |
| EB-43-1000 | | | | | | | | | | | | | | | ● ● ● ● ● ● ● ● ● ● |
| E-53-X-0500 | 5/16 | 7.9 | .187 | 4.8 | .062 | 1.6 | 145 | 10 | 580 | 40.0 | 1-1/8 | 28.5 | .020 | .030 | ○ ● ● ● ● ● ● ● ● ● |
| EB-53-0500 | | | | | | | | | | | | | | | ● ● ● ● ● ● ● ● ● ● |
| E-64-X-0100 | | | | | | | | | | | | | | | ○ ● ● ● ● ● ● ● ● ● |
| E-64-X-0500* | | | | | | | | | | | | | | | ○ ● ● ● ● ● ● ● ● ● |
| E-64-X-1000 | | | | | | | | | | | | | | | ○ ● ● ● ● ● ● ● ● ● |
| EB-64-0100 | 3/8 | 9.5 | .250 | 6.4 | .062 | 1.6 | 125 | 8.6 | 500 | 34.5 | 1-1/4 | 32.0 | .025 | .037 | ● ● ● ● ● ● ● ● ● ● |
| EB-64-0500 | | | | | | | | | | | | | | | ● ● ● ● ● ● ● ● ● ● |
| EB-64-0500-NSF | | | | | | | | | | | | | | | ● ● ● ● ● ● ● ● ● ● |
| E-86-X-0100 | | | | | | | | | | | | | | | ○ ● ● ● ● ● ● ● ● ● |
| E-86-X-0500 | | | | | | | | | | | | | | | ○ ● ● ● ● ● ● ● ● ● |
| EB-86-0100 | 1/2 | 12.7 | .375 | 9.5 | .062 | 1.6 | 90 | 6.2 | 360 | 24.8 | 2-1/2 | 63.5 | .034 | .051 | ● ● ● ● ● ● ● ● ● ● |
| EB-86-0500 | | | | | | | | | | | | | | | ● ● ● ● ● ● ● ● ● ● |
| EB-86-0500-NSF | | | | | | | | | | | | | | | ● ● ● ● ● ● ● ● ● ● |
| E-108-X-0100 | | | | | | | | | | | | | | | ○ ● ● ● ● ● ● ● ● ● |
| EB-108-0100 | 5/8 | 15.9 | .500 | 12.7 | .062 | 1.6 | 70 | 4.8 | 280 | 19.3 | 4 | 101.5 | .044 | .065 | ● ● ● ● ● ● ● ● ● ● |

Tubing
Thermoplastic
B

Coiled Air Hose
& Fittings
C

Transportation
D

Fittings
E

Tooling, Equipment
& Accessories
F

General Technical
G

* E-43-X-0500 and E-64-X-0500 tubing available in natural and white (WHT)

Colors

- Available in black as well as nine other colors, as suggested by the Instrument Society of America

| Color Code | | |
|------------|-----|---------|
| ○ | - | Natural |
| ● | EB | Black |
| ● | B | Blue |
| ● | G | Green |
| ● | O | Orange |
| ● | P | Purple |
| ● | R | Red |
| ● | GRA | Gray |
| ● | Y | Yellow |
| ○ | WHT | White |

Polyethylene Tubing (Series E/EB) Maximum Working Pressure (psi)

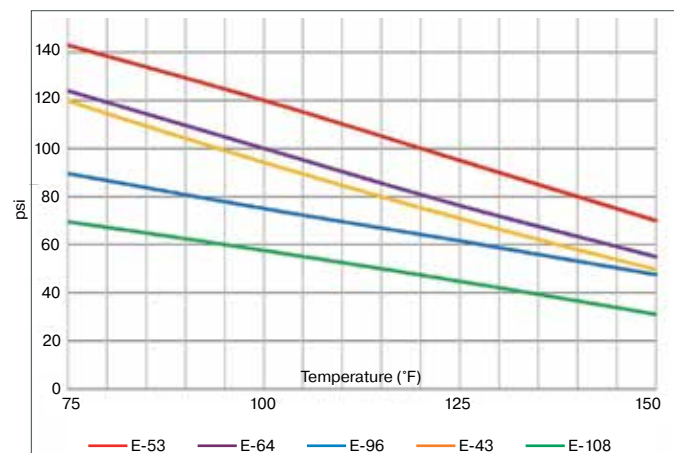

WARNING

This product can expose you to chemicals including Titanium dioxide, which is known to the State of California to cause cancer. For more information go to www.P65Warnings.ca.gov.

Polyethylene Tubing

Series E: Instrument Grade

Series EB: Ultraviolet (UV) resistant

Series E/EB - PE Metric Size Tubing - Natural and Colors

| Part Number | Nominal O.D. | | Nominal I.D. | | Average Wall Thickness | | Working Pressure 73°F (23°C) | | Minimum Burst Pressure | | Minimum Bend Radius | | Weight | | Color |
|---------------------------------|--------------|------|--------------|------|------------------------|------|------------------------------|-----|------------------------|-----|---------------------|-------|--------|----------|-------|
| | mm | inch | mm | inch | mm | inch | bar | psi | bar | psi | mm | inch | kg/mtr | lbs./ft. | |
| E-6X1-0100 EB-6X1-0100 | 6 | .236 | 4.0 | .157 | 1.00 | .039 | 8.6 | 125 | 34.5 | 500 | 25.0 | 1 | .019 | .013 | ○ ● |
| E-8X1-0100 EB-8X1-0100 | 8 | .315 | 6.0 | .236 | 1.00 | .039 | 6.9 | 100 | 27.6 | 400 | 38.0 | 1-1/2 | .021 | .014 | ○ ● |
| E-10X1.5-0100 EB-10X1.5-0100 | 10 | .394 | 7.0 | .276 | 1.50 | .059 | 8.6 | 125 | 34.5 | 500 | 38.0 | 1-1/2 | .039 | .026 | ○ ● |
| E-12X1.5-0100 EB-12X1.5-0100 | 12 | .472 | 9.0 | .354 | 1.50 | .059 | 6.2 | 90 | 24.8 | 360 | 63.0 | 2-1/2 | .048 | .032 | ○ ● |

Colors

- Metric sizes

| Color Code | | |
|------------|----|---------|
| ○ | - | Natural |
| ● | EB | Black |

Polyethylene Metric Tubing (Series E/EB) Maximum Working Pressure (bar)

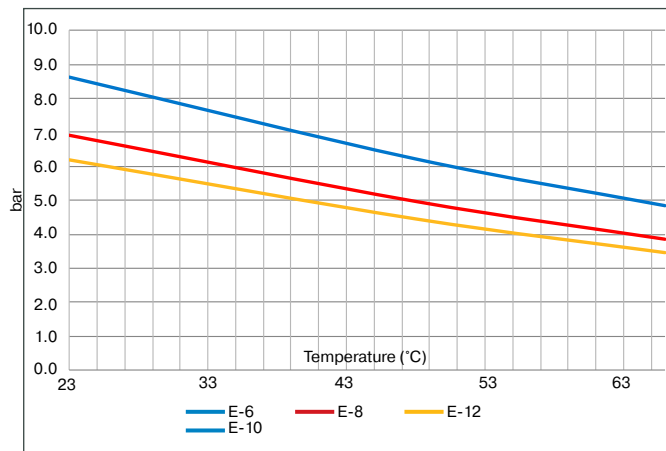

WARNING

This product can expose you to chemicals including Titanium dioxide, which is known to the State of California to cause cancer. For more information go to www.P65Warnings.ca.gov.

Polyethylene Tubing

Series PEFR: Flame Resistant

Flame Resistant.



Features

- Flame resistant
- High strength & excellent flexibility
- Resistant to environmental stress cracking

Compliance

- UL 94 V-2
- ASTM D-1693

Notes

- Produced from LLDPE (linear low density polyethylene) resin
- Resistant to environmental stress cracking as measured by ASTM D-1693 (10% IGEPAL)
- Suggested operating temperature range is -85°F (-65°C) to 150°F (66°C) - reference Pressure vs. Temperature charts as pressures are lower at elevated temperatures
- Working pressure and burst pressure are at 73°F (23°C)

Fittings

- Parker Fittings available from:
Fluid System Connectors Division
Otsego, MI
- (269) 692-6555
(269) 692-6634 FAX
parker.com/fsc
- For approved fittings and/or suggested use of tube supports, reference Tube/Fitting Compatibility Chart (pg. B-8/B-9) or contact Parker Fluid Systems Connectors Division

Order Information

Example: PEFR-4-0500

PEFR-4-0500 – Flame Resistant Polyethylene

PEFR-4-0500 – Tube O.D. in sixteenths of an inch (1/4")

PEFR-4-0500 – Package Quantity in feet (500')



WARNING

This product can expose you to chemicals including Antimony Oxide (Antimony Trioxide), which is known to the State of California to cause cancer, and 2-Imidazolidinethione, which is known to the State of California to cause birth defects or other reproductive harm. For more information go to www.P65Warnings.ca.gov.

Polyethylene Tubing

Series PEFR: Flame Resistant

Series PEFR - Flame Resistant Polyethylene Size Tubing

| Part Number | Nominal O.D. | | Nominal I.D. | | Average Wall Thickness | | Working Pressure 73°F (23°C) | | Minimum Burst Pressure | | Minimum Bend Radius | | Weight | | Color |
|----------------------------|--------------|------|--------------|-----|------------------------|-----|------------------------------|------|------------------------|------|---------------------|------|----------|--------|-------|
| | inch | mm | inch | mm | inch | mm | psi | bar | psi | bar | inch | mm | lbs./ft. | kg/mtr | |
| PEFR-2.5-0500 | 5/32 | 4.0 | .096 | 2.4 | .030 | 0.8 | 185 | 12.8 | 740 | 51.0 | 1/2 | 12.5 | .006 | .009 | |
| PEFR-4-0500 PEFR-4-1000 | 1/4 | 6.4 | .170 | 4.3 | .040 | 1.0 | 140 | 9.7 | 560 | 38.6 | 3/4 | 19.0 | .012 | .018 | ● |
| PEFR-6-0500 | 3/8 | 9.5 | .250 | 6.4 | .062 | 1.6 | 155 | 10.7 | 620 | 42.8 | 1-1/2 | 38.0 | .029 | .043 | ● |
| PEFR-8-0250 | 1/2 | 12.7 | .375 | 9.5 | .062 | 1.6 | 100 | 6.9 | 400 | 27.6 | 1-3/4 | 44.5 | .041 | .061 | ● |

Note: If color not referenced, contact the division for availability.

Flame Resistant Polyethylene Tubing (Series PEFR) Maximum Working Pressure (psig)

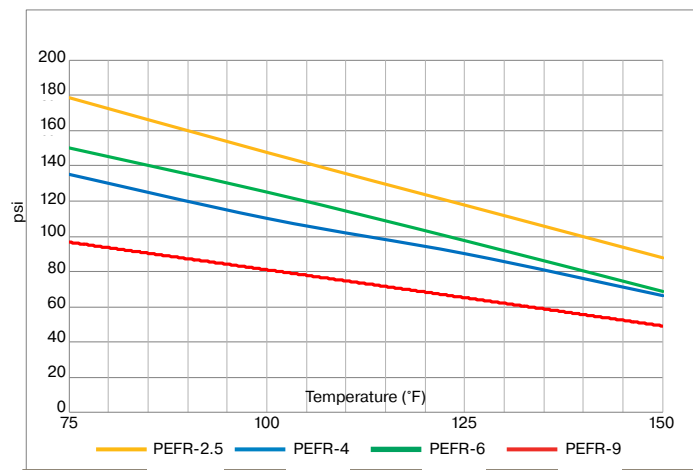

Colors

| Color Code | |
|------------|---------|
| ● | - Black |



WARNING

This product can expose you to chemicals including Antimony Oxide (Antimony Trioxide), which is known to the State of California to cause cancer, and 2-Imidazolidinethione, which is known to the State of California to cause birth defects or other reproductive harm. For more information go to www.P65Warnings.ca.gov.

Polyethylene Tubing

Series HDPE: High Strength

Excellent economical alternative to Nylon tubing.



Features

- Manufactured from high strength, high density polyethylene
- Excellent economical alternative to Nylon in various industrial applications due to strength and durability
- Economical system solution

Notes

- Suggested operating temperature range is -80°F (-62°C) to 175°F (80°C) - reference Pressure vs. Temperature charts as pressures are lower at elevated temperatures
- Working pressure and burst pressure are at 73°F (23°C)

Fittings

- Parker Fittings available from:
Fluid System Connectors Division
Otsego, MI
- (269) 692-6555
(269) 692-6634 FAX
parker.com/fsc
- For approved fittings and/or suggested use of tube supports, reference Tube/Fitting Compatibility Chart (pg. B-8/B-9) or contact Parker Fluid Systems Connectors Division

Order Information

Example: HDPE-43-0500

HDPE-43-0500 – High Density Polyethylene

HDPE-43-0500 – Tube O.D. in sixteenths of an inch (1/4")

HDPE-43-0500 – Tube I.D. in sixteenths of an inch (.170")

HDPE-43-0500 – Package Quantity in feet (500')



WARNING

This product can expose you to chemicals including Titanium dioxide, which is known to the State of California to cause cancer. For more information go to www.P65Warnings.ca.gov.

Polyethylene Tubing

Series HDPE: High Strength

Series HDPE - High Strength Polyethylene Size Tubing

| Part Number | Nominal O.D. | | Nominal I.D. | | Average Wall Thickness | | Working Pressure 73°F (23°C) | | Minimum Burst Pressure | | Minimum Bend Radius | | Weight | | Color |
|--------------|--------------|-----|--------------|-----|------------------------|-----|------------------------------|------|------------------------|------|---------------------|------|----------|--------|-------|
| | inch | mm | inch | mm | inch | mm | psi | bar | psi | bar | inch | mm | lbs./ft. | kg/mtr | |
| HDPE-43-0250 | 1/4 | 6.4 | .170 | 4.3 | .040 | 1.0 | 300 | 20.7 | 1200 | 82.7 | 1-1/2 | 38.0 | .011 | .016 | ● |
| HDPE-43-0500 | | | | | | | | | | | | | | | ● |
| HDPE-64-0250 | 3/8 | 9.5 | .250 | 6.4 | .062 | 1.6 | 300 | 20.7 | 1200 | 82.7 | 2-1/2 | 63.5 | .025 | .037 | ● |
| HDPE-64-0500 | | | | | | | | | | | | | | | ● |

High Density Polyethylene Tubing (Series HDPE) Maximum Working Pressure (psig)

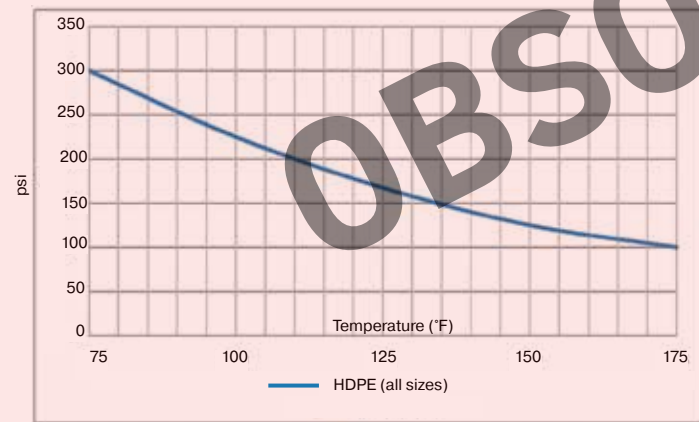

Colors

| Color Code | | |
|------------|---|-------|
| ● | - | Black |



WARNING

This product can expose you to chemicals including Titanium dioxide, which is known to the State of California to cause cancer. For more information go to www.P65Warnings.ca.gov.

Nylon Tubing

Series N/NB Fractional and Metric

Abrasion resistant, heat and light stabilized resin.



Features

- Produced from abrasion resistant, heat and light stabilized nylon resin
- High-grade resins for strength and flexibility
- Low moisture absorption
- Chemically resistant
- EZ pack (100') boxes available

Notes

- Black (Series NB) tubing suggested for use in sunlit areas and in proximity to high UV light sources
- Suggested operating temperature range is -65°F (-54°C) to 200°F (93°C) - reference Pressure vs. Temperature charts as pressures are lower at elevated temperatures
- Working pressure and burst pressure are at 73°F (23°C)

Fittings

- Parker Fittings available from:
Fluid System Connectors Division
Otsego, MI
- (269) 692-6555
(269) 692-6634 FAX
parker.com/fsc
- For approved fittings and/or suggested use of tube supports, reference Tube/Fitting Compatibility Chart (pg. B-8/B-9) or contact Parker Fluid Systems Connectors Division

Order Information

Example: **N-4-035-Red**

N-4-035-Red – Nylon

N-4-035-Red – Tube O.D. in sixteenths of an inch (1/4")

N-4-035-Red – Wall Thickness in inches (.035")

N-4-035-Red – Color, i.e. Red (Omit for Natural and Black)

NN-4-035-EZ - 100 ft box, Natural Nylon

NB-4-035-0100 - Black Nylon

N-4-035-Red – Package Quantity in feet (250')

Standard 250' package has no length reference.

Add -EZ for 100' boxed coil (NB-4-035-EZ)

Order Information

Example: **NN4x.65**

NN4x.65 – Nylon

NN4x.65 – Tube O.D. in millimeters (4)

NN4x.65 – Wall Thickness in millimeters (.65)

(Standard 100' package has no length reference)

WARNING

This product can expose you to chemicals including Nickel, which is known to the State of California to cause cancer. For more information go to www.P65Warnings.ca.gov.

Nylon Tubing

Series N/NB Fractional and Metric

Series N - Nylon Fractional Size Tubing

| Part Number | Nominal O.D. | | Nominal I.D. | | Average Wall Thickness | | Working Pressure 73°F (23°C) | | Minimum Burst Pressure | | Minimum Bend Radius | | Weight | | Color |
|---|--------------|-----|--------------|-----|------------------------|-----|---------------------------------|------|------------------------|-------|---------------------|------|----------|--------|-----------|
| | inch | mm | inch | mm | inch | mm | psi | bar | psi | bar | inch | mm | lbs./ft. | kg/mtr | |
| NN-2-016 NB-2-016 N-2-016-XXX | 1/8 | 3.2 | .093 | 2.4 | .016 | 0.4 | 250 | 17.2 | 1000 | 69.0 | 1/2 | 12.5 | .003 | .004 | ● |
| NN-2-031 NB-2-031 N-2-031-XXX | 1/8 | 3.2 | .064 | 1.6 | .031 | 0.8 | 500 | 34.5 | 2000 | 137.9 | 1/4 | 6.5 | .004 | .006 | ● |
| NN-2.5-025 NB-2.5-025 N-2.5-025-XXX | 5/32 | 4.0 | .106 | 2.7 | .025 | 0.6 | 300 | 20.7 | 1200 | 82.7 | 1/2 | 12.5 | .005 | .007 | ● ● ● ● ● |
| NN-3-025 NB-3-025 N-3-025-XXX | 3/16 | 4.8 | .138 | 3.5 | .025 | 0.6 | 250 | 17.2 | 1000 | 69.0 | 5/8 | 16.0 | .006 | .009 | ● |
| NN-3-046 NB-3-046 N-3-046-XXX | 3/16 | 4.8 | .096 | 2.4 | .046 | 1.2 | 500 | 34.5 | 2000 | 137.9 | 7/16 | 11.0 | .009 | .013 | ● |
| NN-4-035 NB-4-035-EZ NB-4-035 NB-4-035-EZ N-4-035-XXX | 1/4 | 6.4 | .180 | 4.6 | .035 | 0.9 | 250 | 17.2 | 1000 | 69.0 | 7/8 | 22.0 | .011 | .016 | ● ● ● ● ● |
| NN-4-040 NB-4-040-EZ NB-4-040 NB-4-040-EZ N-4-040-XXX | 1/4 | 6.4 | .170 | 4.3 | .040 | 1.0 | 310 | 21.4 | 1250 | 86.2 | 7/8 | 22.0 | .012 | .018 | ● ● ● ● ● |
| NN-4-062 NB-4-062 N-4-062-XXX | 1/4 | 6.4 | .125 | 3.2 | .062 | 1.6 | 500 | 34.5 | 2000 | 137.9 | 1/2 | 12 | .017 | .025 | ● |
| NN-5-040 NB-5-040 N-5-040-XXX | 5/16 | 7.9 | .233 | 5.9 | .040 | 1.0 | 250 | 17.2 | 1000 | 69.0 | 1-1/8 | 28.5 | .016 | .024 | ● |

Note: If color not referenced, contact the division for availability.
 Standard 250' package has no length reference.
 -EZ : 100' EZ pack box



WARNING

This product can expose you to chemicals including Nickel, which is known to the State of California to cause cancer. For more information go to www.P65Warnings.ca.gov.

Nylon Tubing

Series N/NB Fractional and Metric

Hose
A

Series N - Nylon Fractional Size Tubing

| Part Number | Nominal O.D. | | Nominal I.D. | | Average Wall Thickness | | Working Pressure 73°F (23°C) | | Minimum Burst Pressure | | Minimum Bend Radius | | Weight | | Color |
|--------------|--------------|------|--------------|-----|------------------------|-----|------------------------------|------|------------------------|-------|---------------------|------|----------|--------|-----------|
| | inch | mm | inch | mm | inch | mm | psi | bar | psi | bar | inch | mm | lbs./ft. | kg/mtr | |
| NN-6-050 | 3/8 | 9.5 | .275 | 7.0 | .050 | 1.3 | 250 | 17.2 | 1000 | 69.0 | 1-1/8 | 28.5 | .023 | .034 | ○ |
| NN-6-050-EZ | | | | | | | | | | | | | | | ○ |
| NB-6-050 | | | | | | | | | | | | | | | ● |
| NB-6-050-EZ | | | | | | | | | | | | | | | ● |
| N-6-050-XXX | | | | | | | | | | | | | | | ● ● ● ● ● |
| NN-6-093 | 3/8 | 9.5 | .190 | 4.8 | .093 | 2.4 | 500 | 34.5 | 2000 | 137.9 | 3/4 | 19.0 | .038 | .057 | ○ |
| NB-6-093 | | | | | | | | | | | | | | | ● |
| N-6-093-XXX | | | | | | | | | | | | | | | ○ |
| NN-8-062 | 1/2 | 12.7 | .375 | 9.5 | .062 | 1.6 | 250 | 17.2 | 1000 | 69.0 | 1-1/4 | 32.0 | .039 | .058 | ○ |
| NN-8-062-EZ | | | | | | | | | | | | | | | ○ |
| NB-8-062 | | | | | | | | | | | | | | | ● |
| NB-8-062-EZ | | | | | | | | | | | | | | | ● |
| NN-8-062-XXX | | | | | | | | | | | | | | | ○ |
| NN-8-124 | 1/2 | 12.7 | .253 | 6.4 | .124 | 3.2 | 500 | 34.5 | 2000 | 137.9 | 1 | 25.5 | .067 | .100 | ○ |
| NB-8-124 | | | | | | | | | | | | | | | ● |
| N-8-124-XXX | | | | | | | | | | | | | | | ○ |

Note: If color not referenced, contact the division for availability.
 Standard 250' package has no length reference.
 -EZ: 100' EZ pack box

Tubing
Thermoplastic
B

Coiled Air Hose
& Fittings
C

Transportation
D

Fittings
E

Tooling, Equipment
& Accessories
F

General Technical
G

Colors

| Color Code | | |
|------------|-----|---------|
| ○ | NN | Natural |
| ● | NB | Black |
| ● | BLU | Blue |
| ● | GRN | Green |
| ● | RED | Red |
| ● | YEL | Yellow |

Nylon Tubing (Series N/NB) Maximum Working Pressure (psi)

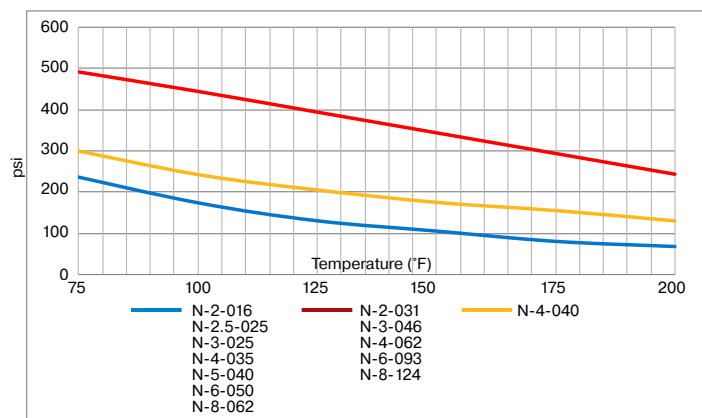

WARNING

This product can expose you to chemicals including Nickel, which is known to the State of California to cause cancer. For more information go to www.P65Warnings.ca.gov.

Nylon Tubing

Series N/NB Fractional and Metric

Hose
A

Series N/NB - Nylon Metric Size Tubing - Natural and Black

| Part Number | Nominal O.D. | | Nominal I.D. | | Average Wall Thickness | | Working Pressure 73°F (23°C) | | Minimum Burst Pressure | | Minimum Bend Radius | | Weight | | Color |
|----------------------|--------------|------|--------------|------|------------------------|------|---------------------------------|-----|------------------------|------|---------------------|--------|--------|----------|--------|
| | mm | inch | mm | inch | mm | inch | bar | psi | bar | psi | mm | inch | kg/mtr | lbs./ft. | |
| NN4x.65 NB4x.65 | 4 | .157 | 2.7 | .106 | 0.65 | .026 | 26.0 | 377 | 104 | 1508 | 14.0 | 9/16 | .007 | .005 | ○ ● |
| NN6X1 NB6X1 | 6 | .236 | 4.0 | .157 | 1.00 | .039 | 23.5 | 340 | 94 | 1363 | 22.0 | 7/8 | .016 | .011 | ○ ● |
| NN8X1 NB8X1 | 8 | .315 | 6.0 | .236 | 1.00 | .039 | 17.0 | 246 | 68 | 986 | 29.0 | 1-1/8 | .024 | .016 | ○ ● |
| NN10X1 NB10X1 | 10 | .394 | 8.0 | .315 | 1.00 | .039 | 12.5 | 181 | 50 | 725 | 34.0 | 1-5/16 | .030 | .020 | ○ ● |
| NN12X1 NB12X1 | 12 | .472 | 10.0 | .394 | 1.00 | .039 | 11.0 | 159 | 44 | 638 | 45.0 | 1-3/4 | .036 | .024 | ○ ● |
| NN14X1.5 NB14X1.5 | 14 | .551 | 11.0 | .433 | 1.50 | .059 | 15.0 | 217 | 60 | 870 | 57.0 | 2-1/4 | .063 | .042 | ○ |
| NN16X1.5 NB16X1.5 | 16 | .630 | 13.0 | .512 | 1.50 | .059 | 12.5 | 181 | 50 | 725 | 74.0 | 2-7/8 | .073 | .049 | ○ |
| NN18X1.5 NB18X1.5 | 18 | .709 | 15.0 | .591 | 1.50 | .059 | 10.5 | 152 | 42 | 609 | 92.0 | 3-5/8 | .082 | .055 | ○ |
| NN20X1.5 NB20X1.5 | 20 | .787 | 17.0 | .669 | 1.50 | .059 | 9.5 | 137 | 38 | 551 | 112.0 | 4-3/8 | .092 | .062 | ○ |

Note: If color not referenced, contact the division for availability.
Standard 100" package has no length reference.

Tubing
Thermoplastic
B

Coiled Air Hose
& Fittings
C

Transportation
D

Fittings
E

Colors

- Metric sizes

| Color Code | | |
|------------|----|---------|
| ○ | NN | Natural |
| ● | NB | Black |

Nylon Metric Tubing (Series N/NB) Maximum Working Pressure (bar)

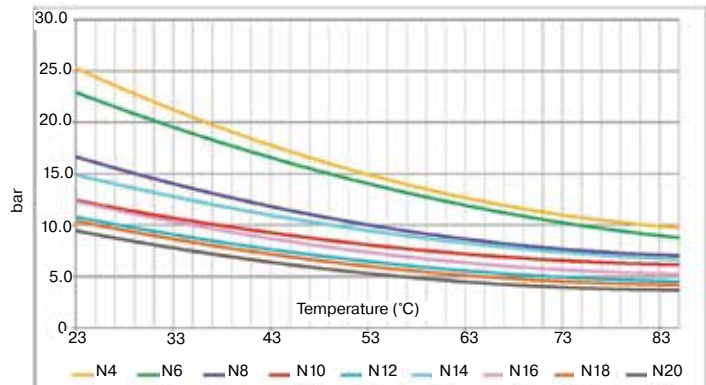

WARNING

This product can expose you to chemicals including Nickel, which is known to the State of California to cause cancer. For more information go to www.P65Warnings.ca.gov.

Tooling, Equipment,
& Accessories
F

General Technical
G

Nylon Tubing

Series PAT: Pure Air Tubing

Excellent chemical and UV light resistance.



Features

- Specially formulated nylon for pure air systems and gas distribution systems (semiconductor) due to its cleanliness and excellent chemical and UV light resistance
- Low moisture absorption
- High tensile strength

Notes

- Packaged on a corrugated plastic reel with ends capped and shipped in plastic-lined container
- PAT2 and PAT4 are single-wall extruded Nylon and PAT6 to PAT12 are reinforced constructions
- Suggested operating temperature range is -70°F (-57°C) to 200°F (93°C). Reference Pressure vs. Temperature charts as pressures are lower at elevated temperatures
- Working pressure and burst pressure are at 73°F (23°C)

Fittings

- Parker Fittings available from:
Fluid System Connectors Division
Otsego, MI
- (269) 692-6555
(269) 692-6634 FAX
parker.com/fsc
- For approved fittings and/or suggested use of tube supports, reference Tube/Fitting Compatibility Chart (pg. B-8/B-9) or contact Parker Fluid Systems Connectors Division

Order Information

Example: PAT4-BLK-1000

PAT4-BLK-1000 – Nylon

PAT4-BLK-1000 – Tube O.D. in sixteenths of an inch (1/8")

PAT4-BLK-1000 – Black (Omit for Natural)

PAT4-BLK-1000 – Package Quantity in feet (1000')

WARNING

This product can expose you to chemicals including Nickel, which is known to the State of California to cause cancer. For more information go to www.P65Warnings.ca.gov.

Nylon Tubing

Series PAT: Pure Air Tubing

Series PAT - Pure Air Nylon Tubing

| Part Number | Nominal O.D. | | Nominal I.D. | | Average Wall Thickness | | Working Pressure 73°F (23°C) | | Minimum Burst Pressure | | Minimum Bend Radius | | Weight | |
|---------------|--------------|------|--------------|------|------------------------|-----|---------------------------------|------|------------------------|------|---------------------|------|----------|--------|
| | inch | mm | inch | mm | inch | mm | bar | psi | psi | bar | inch | mm | lbs./ft. | kg/mtr |
| PAT2-XXX-1000 | 1/8 | 3.2 | .079 | 2.0 | .023 | 0.6 | 250 | 17.2 | 1000 | 69.0 | 3/8 | 9.5 | .003 | .004 |
| PAT4-XXX-1000 | 1/4 | 6.4 | .170 | 4.3 | .040 | 1.0 | 300 | 20.7 | 1200 | 82.7 | 1 | 25.5 | .012 | .018 |
| PAT6-XXX-500 | 3/8 | 9.5 | .251 | 6.4 | .062 | 1.6 | 350 | 24.1 | 1400 | 96.4 | 1-1/2 | 38.0 | .027 | .040 |
| PAT8-XXX-500 | 1/2 | 12.7 | .376 | 9.6 | .062 | 1.6 | 235 | 16.2 | 950 | 65.5 | 2 | 51.0 | .038 | .057 |
| PAT12-XXX-250 | 3/4 | 19.1 | .566 | 14.4 | .092 | 2.3 | 200 | 13.8 | 800 | 55.2 | 3 | 76.0 | .088 | .131 |

Note: If color not referenced, contact the division for availability.

Nylon Tubing (Series PAT) Maximum Working Pressure (psi)

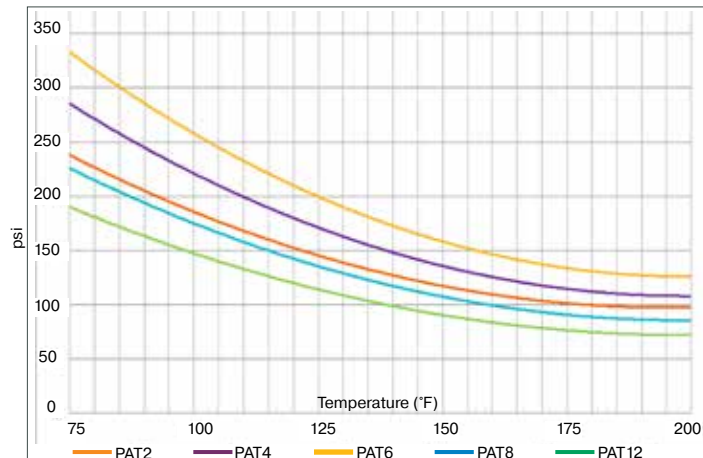

Colors

| Color Code | | |
|------------|-----|--------|
| ● | BLK | Black |
| ● | SIL | Silver |
| ● | BRN | Brown |



WARNING

This product can expose you to chemicals including Nickel, which is known to the State of California to cause cancer. For more information go to www.P65Warnings.ca.gov.

Nylon Tubing

Series NR/NBR: Semi-Rigid High Strength

High tensile strength yielding
excellent coupling retention.



Features

- High grade nylon resins without plasticizers for higher pressure tubing applications
- High tensile strength and excellent coupling retention
- Produced from abrasion resistant, heat and light stabilized nylon resin
- Low moisture absorption
- Chemically resistant

Notes

- Black (Series NBR) tubing suggested for use in sunlit areas and in proximity to high UV light sources
- Suggested operating temperature range is -60°F (-51°C) to 200°F (93°C) - reference Pressure vs. Temperature charts as pressures are lower at elevated temperatures
- Working pressure and burst pressure are at 73°F (23°C)

Fittings

- Parker Fittings available from:
Fluid System Connectors Division
Otsego, MI
- (269) 692-6555
(269) 692-6634 FAX
parker.com/fsc
- For approved fittings and/or suggested use of tube supports, reference Tube/Fitting Compatibility Chart (pg. B-8/B-9) or contact Parker Fluid Systems Connectors Division

Order Information

Example: **NBR-2-017**

NBR-2-017 – Nylon

NBR-2-017 – Black

NBR-2-017 – Rigid

NBR-2-017 – Tube O.D. in sixteenths of an Inch (1/8")

NBR-2-017 – Wall Thickness in inches (.017")

NBR-2-017 – Package Quantity in feet (250')

Standard 250' package has no length reference.



WARNING

This product can expose you to chemicals including Nickel, which is known to the State of California to cause cancer. For more information go to www.P65Warnings.ca.gov.

Nylon Tubing

Series NR/NBR: Semi-Rigid High Strength

Series NR/NBR - Semi-Rigid High Strength Nylon Tubing - Natural and Black

| Part Number | Nominal O.D. | | Nominal I.D. | | Average Wall Thickness | | Working Pressure 73°F (23°C) | | Minimum Burst Pressure | | Minimum Bend Radius | | Weight | | Color |
|------------------------|--------------|------|--------------|-----|------------------------|-----|---------------------------------|------|------------------------|-------|---------------------|------|----------|--------|-------|
| | inch | mm | inch | mm | inch | mm | psi | bar | psi | bar | mm | inch | lbs./ft. | kg/mtr | |
| NNR-2-017 NBR-2-017 | 1/8 | 3.2 | .091 | 2.3 | .017 | 0.4 | 425 | 29.3 | 1700 | 117.2 | 1/2 | 12.5 | .003 | .004 | ○ |
| NNR-2-026 NBR-2-026 | 1/8 | 3.2 | .073 | 1.9 | .026 | 0.7 | 625 | 43.1 | 2500 | 172.4 | 3/8 | 9.5 | .004 | .006 | ● |
| NNR-3-024 NBR-3-024 | 3/16 | 4.8 | .140 | 3.6 | .024 | 0.6 | 425 | 29.3 | 1700 | 117.2 | 3/4 | 19.0 | .006 | .009 | ○ |
| NNR-3-039 NBR-3-039 | 3/16 | 4.8 | .110 | 2.8 | .039 | 1.0 | 625 | 43.1 | 2500 | 172.4 | 5/8 | 16.0 | .008 | .012 | ● |
| NNR-4-035 NBR-4-035 | 1/4 | 6.4 | .180 | 4.6 | .035 | 0.9 | 425 | 29.3 | 1700 | 117.2 | 1 | 25.5 | .011 | .016 | ● |
| NNR-4-050 NBR-4-050 | 1/4 | 6.4 | .150 | 3.8 | .050 | 1.3 | 625 | 43.1 | 2500 | 172.4 | 7/8 | 22.0 | .014 | .021 | ● |
| NNR-5-040 NBR-5-040 | 5/16 | 7.9 | .233 | 5.9 | .040 | 1.0 | 425 | 29.3 | 1700 | 117.2 | 1-1/2 | 38.0 | .015 | .022 | ● |
| NNR-6-048 NBR-6-048 | 3/8 | 9.5 | .279 | 7.1 | .048 | 1.2 | 425 | 29.3 | 1700 | 117.2 | 1-3/4 | 44.5 | .022 | .033 | ● |
| NNR-6-075 NBR-6-075 | 3/8 | 9.5 | .225 | 5.7 | .075 | 1.9 | 625 | 43.1 | 2500 | 172.4 | 1-1/2 | 38.0 | .032 | .048 | ● |
| NNR-8-062 NBR-8-062 | 1/2 | 12.7 | .375 | 9.5 | .062 | 1.6 | 375 | 25.9 | 1500 | 103.4 | 2-3/8 | 60.5 | .038 | .057 | ● |
| NNR-8-075 NBR-8-075 | 1/2 | 12.7 | .350 | 8.9 | .075 | 1.9 | 625 | 43.1 | 2500 | 172.4 | 2-1/2 | 63.5 | .045 | .067 | ● |

Note: If color not referenced, contact the division for availability.
 Standard pack part number has no length reference.
 Package quantity: -2 to -3 is 500' -4 to -8 is 250'

Colors

| Color Code | | |
|------------|-----|---------|
| ○ | NNR | Natural |
| ● | NBR | Black |

Nylon Tubing (Series NR) Maximum Working Pressure (psi)

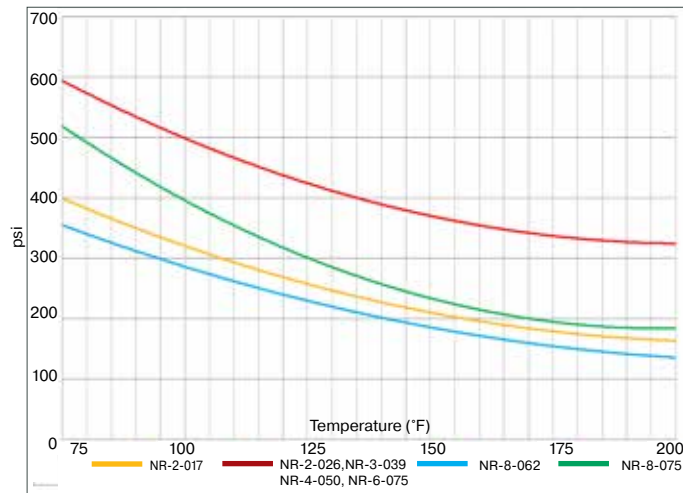

WARNING

This product can expose you to chemicals including Nickel, which is known to the State of California to cause cancer. For more information go to www.P65Warnings.ca.gov.

Polypropylene Tubing

Series PP: Laboratory Grade – FDA, NSF Listed
 Series PPB: Ultraviolet Light Resistant

Less than .01% water absorption.



Features

- Excellent resistance to hot water, acids, chemicals and vegetable oils
- Low water absorption (less than .01%)
- Excellent resistance to stress cracking

Compliance

- PP-series (white) tubing only
 - FDA, CFR21 Part 177 compliant for Food Contact
 - NSF-51 compliant

Notes

- Black (Series PPB) tubing suggested for use in sunlit areas and in proximity to high UV light sources
- Suggested operating temperature range is 0°F (-18°C) to 200°F (93°C) - reference Pressure vs. Temperature charts as pressures are lower at elevated temperatures
- Working pressure and burst pressure are at 73°F (23°C)

Fittings

- Parker Fittings available from:
 Fluid System Connectors Division
 Otsego, MI
- (269) 692-6555
 (269) 692-6634 FAX
parker.com/fsc
- For approved fittings and/or suggested use of tube supports, reference Tube/Fitting Compatibility Chart (pg. B-8/B-9) or contact Parker Fluid Systems Connectors Division

Order Information

Example: **PP-86-0250**

PP-86-0250 – Polypropylene

PP-86-0250 - White

PPB-86-0250 -Black

PP-86-0250 – Tube O.D. in sixteenths of an inch (1/2")

PP-86-0250 – Tube I.D. in sixteenths of an inch (3/8")

PP-86-0250 – Package Quantity in feet (250')



WARNING

This product can expose you to chemicals including Titanium dioxide, which is known to the State of California to cause cancer. For more information go to www.P65Warnings.ca.gov.

Polypropylene Tubing

Series PP: Laboratory Grade – FDA, NSF Listed

Series PPB: Ultraviolet Light Resistant

Series PP: Laboratory Grade – FDA, NSF Listed - White
Series PPB: Ultraviolet Light Resistant - Black

| Part Number | Nominal O.D. | | Nominal I.D. | | Average Wall Thickness | | Working Pressure 73°F (23°C) | | Minimum Burst Pressure | | Minimum Bend Radius | | Weight | | Color |
|-----------------------------|--------------|------|--------------|------|------------------------|-----|------------------------------|------|------------------------|------|---------------------|-------|----------|--------|--------|
| | inch | mm | inch | mm | inch | mm | psi | bar | psi | bar | inch | mm | lbs./ft. | kg/mtr | |
| PP-21-1000 PPB-21-1000 | 1/8 | 3.2 | .079 | 2.0 | .023 | 0.6 | 350 | 24.1 | 1400 | 96.5 | 1/2 | 12.5 | .003 | .004 | |
| PP-32-0500 PPB-32-0500 | 3/16 | 4.8 | .120 | 3.0 | .034 | 0.9 | 350 | 24.1 | 1400 | 96.5 | 3/4 | 19.0 | .006 | .009 | |
| PP-43-0500 PPB-43-0500 | 1/4 | 6.4 | .170 | 4.3 | .040 | 1.0 | 300 | 20.7 | 1200 | 82.7 | 1 | 25.5 | .010 | .015 | ○ ● |
| PP-53-0500 PPB-53-0500 | 5/16 | 7.9 | .188 | 4.8 | .062 | 1.6 | 350 | 24.1 | 1400 | 96.5 | 1-1/4 | 32.0 | .019 | .028 | |
| PP-64-0500 PPB-64-0500 | 3/8 | 9.5 | .250 | 6.4 | .062 | 1.6 | 300 | 20.7 | 1200 | 82.7 | 1-1/4 | 32.0 | .024 | .036 | ○ ● |
| PP-86-0250 PPB-86-0250 | 1/2 | 12.7 | .375 | 9.5 | .062 | 1.6 | 225 | 15.5 | 900 | 62.1 | 2-1/2 | 63.5 | .033 | .049 | ○ ● |
| PP-108-0100 PPB-108-0100 | 5/8 | 15.9 | .500 | 12.7 | .062 | 1.6 | 175 | 12.1 | 700 | 48.3 | 4 | 101.5 | .042 | .063 | ○ |

Note: If color not referenced, contact the division for availability.

Colors

| Color Code | | |
|------------|-----|-------|
| ○ | PP | White |
| ● | PPB | Black |

Polypropylene Tubing (Series PP & PPB) Maximum Working Pressure (psi)

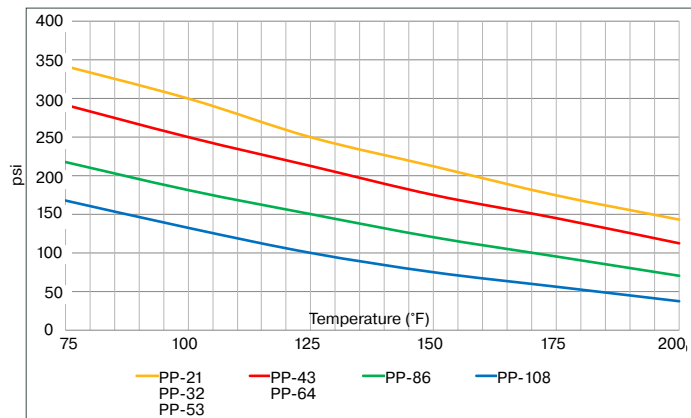

WARNING

This product can expose you to chemicals including Titanium dioxide, which is known to the State of California to cause cancer. For more information go to www.P65Warnings.ca.gov.

Polyurethane Tubing

Series 95U/95UM: Polyether Base

Excellent abrasion
and kink resistance.

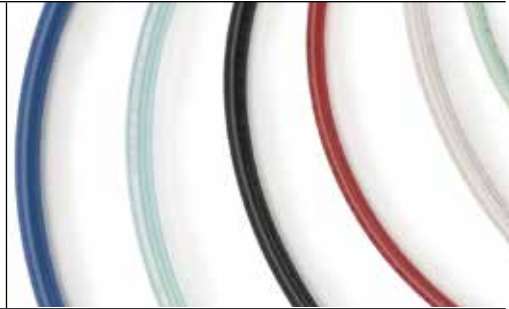

Features

- 95 Shore A durometer
- Excellent abrasion and kink resistance
- Excellent moisture resistance
- Easy to assemble with approved fittings
- Constructed from UV resistant Polyurethane
- Exhibits the elongation and recovery characteristics of rubber and the chemical resistance of a thermoplastic
- EZ Pack 100' boxes available

Notes

- Suggested operating temperature range is -40°F (-40°C) to 180°F (82°C) - reference Pressure vs. Temperature charts as pressures are lower at elevated temperatures
- Working pressure and burst pressure are at 73°F (23°C)

Polyurethane Tubing (Series 95U) Maximum Working Pressure (psi)

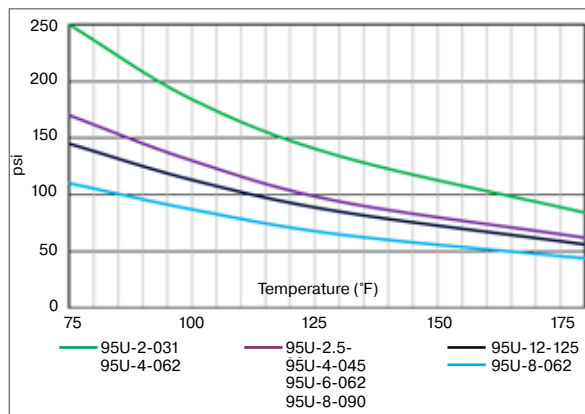

Polyurethane Metric Tubing (Series 95UM) Maximum Working Pressure (bar)

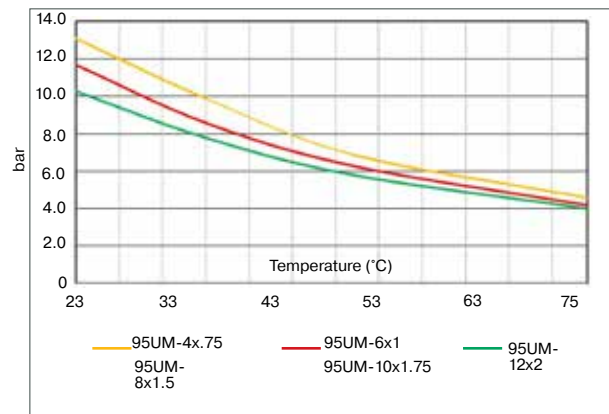

Fittings

- Parker Fittings available from:
Fluid System Connectors Division
Otsego, MI
- (269) 692-6555
(269) 692-6634 FAX
parker.com/fsc
- For approved fittings and/or suggested use of tube supports, reference Tube/Fitting Compatibility Chart (pg. B-8/B-9) or contact Parker Fluid Systems Connectors Division

Order Information

Example: 95U-2-031-RED-0100

- 95U-2-031-RED-0100** – 95 Durometer Polyurethane
- 95U-2-031-RED-0100** – Tube O.D. sixteenths of an inch (1/8")
- 95U-2-031-RED-0100** – Wall Thickness in inches (.031")
- 95U-2-031-RED-0100** – Color
- 95U-2-031-RED-0100** – Package Quantity in feet (100')

WARNING

This product can expose you to chemicals including Carbon Black Extracts, which is known to the State of California to cause cancer and Toluene, which is known to the State of California to cause birth defects or other reproductive harm. For more information go to www.P65Warnings.ca.gov.

Polyurethane Tubing

Series 95U/95UM: Polyether Base

A Hose

Series 95U: PU Tubing - Natural and Colors

| Part Number | Nominal O.D. | | Nominal I.D. | | Average Wall Thickness | | Working Pressure 73°F (23°C) | | Minimum Burst Pressure | | Weight | | Color |
|----------------------|--------------|------|--------------|------|------------------------|------|------------------------------|------|------------------------|------|----------|--------|-----------------|
| | inch | mm | inch | mm | inch | mm | psi | bar | psi | bar | lbs./ft. | kg/mtr | |
| 95U-2-031-XXX-0100 | 1/8 | 3.2 | .063 | 1.6 | .031 | 0.80 | 250 | 17.2 | 750 | 51.6 | .005 | .007 | ○ ● ● ● ● ● ● ● |
| 95U-2-031-XXX-0500 | | | | | | | | | | | | | ○ ● ● ● ● ● ● ● |
| 95U-2.5-031-XXX-0100 | 5/32 | 4.0 | .094 | 2.4 | .031 | 0.80 | 170 | 11.7 | 510 | 35.1 | .006 | .009 | ○ ● ● ● ● ● ● ● |
| 95U-2.5-031-XXX-0500 | | | | | | | | | | | | | ○ ● ● ● ● ● ● ● |
| 95U-4-045-XXX-1000 | 1/4 | 6.4 | .160 | 4.1 | .045 | 1.10 | 170 | 11.7 | 510 | 35.1 | .015 | .023 | ○ |
| 95U-4-062-XXX-0100 | 1/4 | 6.4 | .125 | 3.2 | .062 | 1.60 | 250 | 17.2 | 750 | 51.6 | .019 | .028 | ○ ● ● ● ● ● ● ● |
| 95U-4-062-XXX-0500 | | | | | | | | | | | | | ○ ● ● ● ● ● ● ● |
| 95U-4-062-XXX-1000 | | | | | | | | | | | | | ○ ● ● ● ● ● ● ● |
| 95U-6-062-XXX-0100 | 3/8 | 9.5 | .250 | 6.4 | .062 | 1.60 | 170 | 11.7 | 510 | 35.1 | .030 | .045 | ○ ● ● ● ● ● ● ● |
| 95U-6-062-XXX-0500 | | | | | | | | | | | | | ○ ● ● ● ● ● ● ● |
| 95U-8-062-XXX-0100 | 1/2 | 12.7 | .375 | 9.5 | .062 | 1.60 | 110 | 7.6 | 330 | 22.8 | .042 | .063 | ○ ● ● ● ● ● ● ● |
| 95U-8-062-XXX-0250 | | | | | | | | | | | | | ○ ● ● ● ● ● ● ● |
| 95U-8-090-XXX-0100 | 1/2 | 12.7 | .320 | 8.1 | .090 | 2.30 | 170 | 11.7 | 510 | 35.1 | .059 | .089 | ○ ● ● ● ● ● ● ● |
| 95U-8-090-XXX-0250 | | | | | | | | | | | | | ○ ● ● ● ● ● ● ● |
| 95U-12-125-XXX-0100 | 3/4 | 19.1 | .500 | 12.7 | .125 | 3.20 | 145 | 10.0 | 435 | 30.0 | .125 | .188 | ○ |

B Tubing Thermoplastic

C Coiled Air Hose & Fittings

D Transportation

Series 95UM: PU Metric Size Tubing - Natural and Colors

| Part Number | Nominal O.D. | | Nominal I.D. | | Average Wall Thickness | | Working Pressure 73°F (23°C) | | Minimum Burst Pressure | | Weight | | Color |
|-----------------------|--------------|------|--------------|------|------------------------|------|------------------------------|-----|------------------------|-----|--------|----------|-----------------|
| | mm | inch | mm | inch | inch | mm | bar | psi | bar | psi | kg/mtr | lbs./ft. | |
| 95UM-4x.75-XXX-0100 | 4 | .157 | 2.5 | .098 | 0.75 | .030 | 13.1 | 190 | 39.3 | 570 | .009 | .006 | ○ ● ● ● ● ● ● ● |
| 95UM-4x.75-XXX-0500 | | | | | | | | | | | | | ○ ● ● ● ● ● ● ● |
| 95UM-6x1-XXX-0100 | 6 | .236 | 4.0 | .157 | 1.00 | .039 | 11.7 | 170 | 35.1 | 510 | .019 | .013 | ○ ● ● ● ● ● ● ● |
| 95UM-6x1-XXX-0500 | | | | | | | | | | | | | ○ ● ● ● ● ● ● ● |
| 95UM-8x1.5-XXX-0100 | 8 | .315 | 5.0 | .196 | 1.50 | .059 | 13.1 | 190 | 39.3 | 570 | .036 | .024 | ○ ● ● ● ● ● ● ● |
| 95UM-8x1.5-XXX-0500 | | | | | | | | | | | | | ○ ● ● ● ● ● ● ● |
| 95UM-10x1.75-XXX-0100 | 10 | .393 | 6.5 | .256 | 1.75 | .069 | 11.7 | 170 | 35.1 | 510 | .054 | .036 | ○ ● ● ● ● ● ● ● |
| 95UM-10x1.75-XXX-0500 | | | | | | | | | | | | | ○ ● ● ● ● ● ● ● |
| 95UM-12x2-XXX-0100 | 12 | .472 | 8.0 | .315 | 2.00 | .079 | 10.3 | 150 | 30.9 | 450 | .074 | .049 | ○ ● ● ● ● ● ● ● |
| 95UM-12x2-XXX-0500 | | | | | | | | | | | | | ○ ● ● ● ● ● ● ● |

E Fittings

Colors

| Color Code | | | Color Code | | |
|------------|-----|---------|------------|-----|--------------------|
| ○ | - | Natural | ○ | WHT | White |
| ● | BLK | Black | ● | YEL | Yellow |
| ● | BLU | Blue | ● | TBL | Transparent Blue |
| ● | GRA | Gray | ● | TGR | Transparent Green |
| ● | GRN | Green | ● | TRD | Transparent Red |
| ● | RED | Red | ● | TYL | Transparent Yellow |

Order Information

Example: 95UM-6x1-BLK-0100

- 95UM-6x1-BLK-0100 – 95 Durometer Polyurethane
- 95UM-6x1-BLK-0100 – Tube O.D. in millimeters (6mm)
- 95UM-6x1-BLK-0100 – Tube I.D. in millimeters (1mm)
- 95UM-6x1-BLK-0100 – Color Black (Omit for Natural)
- 95UM-6x1-BLK-0100 – Package Quantity in feet (100')

WARNING

This product can expose you to chemicals including Carbon Black Extracts, which is known to the State of California to cause cancer and Toluene, which is known to the State of California to cause birth defects or other reproductive harm. For more information go to www.P65Warnings.ca.gov.

F Tooling, Equipment, & Accessories

G General Technical

MicroWeld™ Tubing

Series 95FR: Flame Resistant

Weld spatter resistance and excellent flexibility.



Features

- 95 Shore A durometer Polyether Polyurethane core tube
- Easily skived flame resistant jacket protects core tube for extended life
- Silicone and halogen free
- Excellent flexibility
- Weld spatter resistant
- Ideal for air/water supply in robotic welding applications

Compliance

- UL 94 V-0 compliant jacket material

Notes

- Suggested operating temperature range is -40°F (-40°C) to 165°F (74°C) - reference Pressure vs. Temperature charts as pressures are lower at elevated temperatures
- Working pressure and burst pressure are at 73°F (23°C)

MicroWeld Tubing (Series 95FR) Maximum Working Pressure (psi)

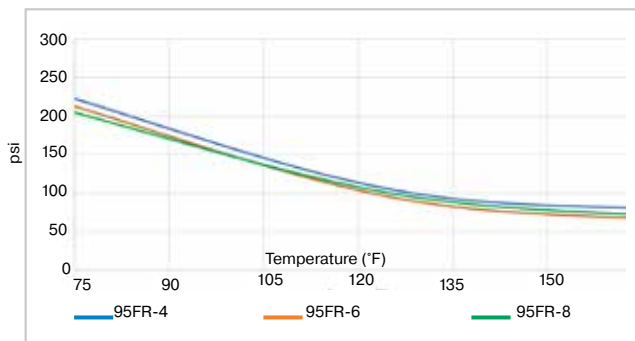

MicroWeld Metric Tubing (Series 95FRM) Maximum Working Pressure (bar)

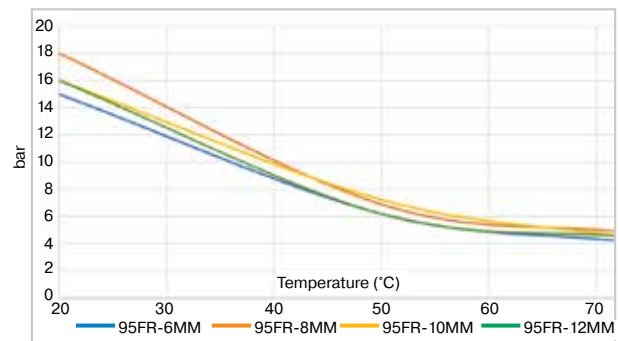

Fittings

- Parker Fittings available from:
Fluid System Connectors Division
Otsego, MI
- (269) 692-6555
(269) 692-6634 FAX
parker.com/fsc
- For approved fittings and/or suggested use of tube supports, reference Tube/Fitting Compatibility Chart (pg. B-8/B-9) or contact Parker Fluid Systems Connectors Division

Order Information

Example: 95FR-4-BLU-0250

95FR-4-BLU-0250 – Flame Resistant Polyurethane

95FR-4-BLU-0250 – Tube O.D. in sixteenths of an inch (1/4")

95FR-4-BLU-0250 – Blue

95FR-4-BLU-0250 – Package Quantity in feet (250')

WARNING

This product can expose you to chemicals including Antimony Oxide (Antimony Trioxide), which is known to the State of California to cause cancer, and 2-Imidazolidinethione, which is known to the State of California to cause birth defects or other reproductive harm. For more information go to www.P65Warnings.ca.gov.

MicroWeld™ Tubing

Series 95FR: Flame Resistant

A Hose

Series 95FR: Jacketed, Fire Resistant Polyurethane Tubing

| Part Number | Nominal O.D. | | Nominal I.D. | | Average Wall Thickness | | Final Sheath O.D. | | Final Sheath Wall Thickness | | Working Pressure 73°F (23°C) | | Minimum Burst Pressure | | Minimum Bend Radius | | Weight | | Color | |
|-----------------|--------------|------|--------------|-----|------------------------|-----|-------------------|------|-----------------------------|-----|------------------------------|------|------------------------|------|---------------------|------|--------|----------|-----------|-----------|
| | inch | mm | inch | mm | inch | mm | inch | mm | inch | mm | psi | bar | psi | bar | inch | mm | kg/mtr | lbs./ft. | | |
| 95FR-4-XXX-0250 | 1/4 | 6.4 | .160 | 4.0 | .045 | 1.1 | .340 | 8.6 | .045 | 1.1 | 240 | 16.5 | 720 | 49.6 | 3/4 | 19.0 | .042 | .062 | ● ● ● ● ● | |
| 95FR-4-XXX-0500 | | | | | | | | | | | | | | | | | | | | ● ● ● ● ● |
| 95FR-6-XXX-0250 | 3/8 | 9.5 | .250 | 6.4 | .062 | 1.6 | .465 | 11.8 | .045 | 1.1 | 230 | 15.9 | 690 | 47.6 | 1 | 25.5 | .069 | .103 | ● ● ● ● ● | |
| 95FR-6-XXX-0500 | | | | | | | | | | | | | | | | | | | | ● ● ● ● ● |
| 95FR-8-XXX-0250 | 1/2 | 12.7 | .320 | 8.1 | .090 | 2.3 | .590 | 15.0 | .045 | 1.1 | 220 | 15.2 | 660 | 45.5 | 2 | 51.0 | .108 | .161 | ● ● ● ● ● | |

B Tubing Thermoplastic

C Coiled Air Hose & Fittings

Series 95FRM: Jacketed, Fire Resistant Metric Polyurethane Tubing

| Part Number | Nominal O.D. | | Nominal I.D. | | Average Wall Thickness | | Final Sheath O.D. | | Final Sheath Wall Thickness | | Working Pressure 73°F (23°C) | | Minimum Burst Pressure | | Minimum Bend Radius | | Weight | | Color | |
|---------------------|--------------|------|--------------|------|------------------------|------|-------------------|------|-----------------------------|------|------------------------------|-----|------------------------|-----|---------------------|-------|--------|----------|-----------|-----------|
| | mm | inch | mm | inch | mm | inch | mm | inch | mm | inch | bar | psi | bar | psi | mm | inch | kg/mtr | lbs./ft. | | |
| 95FRM-6MM-XXX-0250 | 6 | .236 | 4.0 | .157 | 1.00 | .039 | 8.0 | .315 | 1.1 | .045 | 15 | 218 | 45 | 652 | 20.0 | 3/4 | .057 | .038 | ● ● ● ● ● | |
| 95FRM-6MM-XXX-0500 | | | | | | | | | | | | | | | | | | | | ● ● ● ● ● |
| 95FRM-8MM-XXX-0250 | 8 | .315 | 5.0 | .197 | 1.50 | .059 | 10.0 | .394 | 1.1 | .045 | 18 | 261 | 54 | 783 | 22.0 | 7/8 | .085 | .057 | ● ● ● ● ● | |
| 95FRM-8MM-XXX-0500 | | | | | | | | | | | | | | | | | | | | ● ● ● ● ● |
| 95FRM-10MM-XXX-0500 | 10 | .394 | 6.5 | .256 | 1.75 | .069 | 12.0 | .472 | 1.1 | .045 | 16 | 232 | 48 | 696 | 26.0 | 1 | .113 | .076 | ● ● ● ● ● | |
| 95FRM-12MM-XXX-0500 | 12 | .472 | 8.0 | .315 | 2.00 | .079 | 14.0 | .551 | 1.1 | .045 | 16 | 232 | 48 | 696 | 32.0 | 1-1/4 | .144 | .097 | ● ● ● ● ● | |

D Transportation

E Fittings

Colors

| Color Code | | |
|------------|-----|-------|
| ● | BLK | Black |
| ● | BLU | Blue |
| ● | GRA | Gray |
| ● | GRN | Green |
| ● | RED | Red |
| ○ | WHT | White |



WARNING

This product can expose you to chemicals including Antimony Oxide (Antimony Trioxide), which is known to the State of California to cause cancer, and 2-Imidazolidinethione, which is known to the State of California to cause birth defects or other reproductive harm. For more information go to www.P65Warnings.ca.gov.

F Tooling, Equipment, & Accessories

G General Technical

Vinyl Tubing

Series PV: Clear Vinyl Tubing

Instrument and laboratory grade
PVC tubing.



Features

- Made from a virgin clear PVC (polyvinyl chloride) resin; specifically formulated for exceptional purity, clarity and flexibility
- 70 durometer for soft, easy handling and bending without tubing collapse

Compliance

- FDA, CFR21 Part 177 Compliant for Food Contact

Notes

- Formula V-1 tubing fully meets all specifications called out by the United States Food and Drug Administration (FDA) for materials in contact with food and drugs for human consumption
- Phthalate free construction
- Suggested operating temperature range is -40°F (-18°C) to 150°F (65°C - reference Pressure vs. Temperature charts as pressures are lower at elevated temperatures
- Working pressure and burst pressure are at 73°F (23°C)

Fittings

- Parker Fittings available from:
Fluid System Connectors Division
Otsego, MI
- (269) 692-6555
(269) 692-6634 FAX
parker.com/fsc
- For approved fittings and/or suggested use of tube supports, reference Tube/Fitting Compatibility Chart (pg. B-8/B-9) or contact Parker Fluid Systems Connectors Division

Order Information

Example: PV108-1

PV108-1 – Poly-Vinyl

PV108-1 – Tube O.D. in sixteenths of an inch (5/8")

PV108-1 – Tube I.D. in sixteenths of an inch (1/2")

PV108-1 – Formula V-1 FDA Approved Formulation

WARNING

This product can expose you to chemicals including Di (2-ethylhexyl) phthalate (DEHP), which is known to the State of California to cause cancer and birth defects or other reproductive harm. For more information go to www.P65Warnings.ca.gov.

Vinyl Tubing

Series PV: Clear Vinyl Tubing

Series PV - Vinyl Tubing

| Part Number | Tube O.D. | | Tube I.D. | | Average Wall Thickness | | Working Pressure 73°F (23°C) | | Package Qty | Weight | |
|-------------|-----------|------|-----------|------|------------------------|-----|---------------------------------|-----|-------------|--------|----------|
| | inch | mm | inch | mm | inch | mm | psi | bar | | ft | lbs./ft. |
| PV21-1 | 1/8 | 3.2 | .063 | 1.6 | .031 | 0.8 | 35 | 2.4 | 100 | .005 | .007 |
| PV32-1 | .170 | 4.3 | .125 | 3.2 | .025 | 0.6 | 35 | 2.4 | 100 | .006 | .009 |
| PV42-1 | 1/4 | 6.4 | .125 | 3.2 | .063 | 1.6 | 65 | 4.5 | 100 | .025 | .037 |
| PV43-1 | 1/4 | 6.4 | .170 | 4.3 | .040 | 1.2 | 55 | 3.8 | 100 | .014 | .021 |
| PV403-1 | 1/4 | 6.4 | .188 | 4.8 | .031 | 0.8 | 22 | 1.5 | 100 | .011 | .016 |
| PV53-1 | 5/16 | 7.9 | .188 | 4.8 | .063 | 1.6 | 55 | 3.8 | 100 | .025 | .037 |
| PV63-1 | 3/8 | 9.5 | .188 | 4.8 | .094 | 2.4 | 65 | 4.5 | 100 | .043 | .064 |
| PV73-1 | 7/16 | 11.1 | .188 | 4.8 | .125 | 3.2 | 75 | 5.2 | 100 | .063 | .094 |
| PV54-1 | 5/16 | 7.9 | .250 | 6.4 | .031 | 0.8 | 20 | 1.4 | 100 | .014 | .021 |
| PV64-1 | 3/8 | 9.5 | .250 | 6.4 | .064 | 1.6 | 55 | 3.8 | 100 | .032 | .048 |
| PV74-1 | 7/16 | 11.1 | .250 | 6.4 | .094 | 2.4 | 60 | 4.1 | 100 | .052 | .077 |
| PV84-1 | 1/2 | 12.7 | .250 | 6.4 | .125 | 3.2 | 70 | 4.8 | 100 | .076 | .113 |
| PV75-1 | 7/16 | 11.1 | .313 | 7.9 | .063 | 1.6 | 50 | 3.4 | 100 | .038 | .057 |
| PV85-1 | 1/2 | 12.7 | .313 | 7.9 | .094 | 2.4 | 60 | 4.1 | 100 | .062 | .092 |
| PV95-1 | 9/16 | 14.3 | .313 | 7.9 | .125 | 3.2 | 70 | 4.8 | 100 | .088 | .131 |
| PV86-1 | 1/2 | 12.7 | .375 | 9.5 | .063 | 1.6 | 45 | 3.1 | 100 | .044 | .065 |
| PV96-1 | 9/16 | 14.3 | .375 | 9.5 | .094 | 2.4 | 50 | 3.4 | 100 | .071 | .106 |
| PV106-1 | 5/8 | 15.9 | .375 | 9.5 | .125 | 3.2 | 60 | 4.1 | 100 | .101 | .150 |
| PV97-1 | 9/16 | 14.3 | .438 | 11.1 | .063 | 1.6 | 40 | 2.8 | 100 | .050 | .074 |
| PV107-1 | 5/8 | 15.9 | .438 | 11.1 | .094 | 2.4 | 45 | 3.1 | 100 | .080 | .119 |
| PV117-1 | 11/16 | 17.5 | .438 | 11.1 | .125 | 3.2 | 50 | 3.4 | 100 | .115 | .171 |
| PV108-1 | 5/8 | 15.9 | .500 | 12.7 | .063 | 1.6 | 30 | 2.1 | 100 | .057 | .085 |
| PV118-1 | 11/16 | 17.5 | .500 | 12.7 | .094 | 2.4 | 40 | 2.8 | 100 | .089 | .132 |
| PV128-1 | 3/4 | 19.1 | .500 | 12.7 | .125 | 3.2 | 45 | 3.1 | 100 | .126 | .188 |
| PV138-1 | 13/16 | 20.7 | .500 | 12.7 | .156 | 4.0 | 60 | 4.1 | 100 | .167 | .249 |
| PV129-1 | 3/4 | 19.1 | .563 | 14.3 | .094 | 2.4 | 40 | 2.8 | 100 | .099 | .147 |
| PV139-1 | 13/16 | 20.7 | .563 | 14.3 | .125 | 3.2 | 45 | 3.1 | 100 | .138 | .205 |

Colors

| Color Code |
|-------------|
| ○ - Natural |



WARNING

This product can expose you to chemicals including Di (2-ethylhexyl) phthalate (DEHP), which is known to the State of California to cause cancer and birth defects or other reproductive harm. For more information go to www.P65Warnings.ca.gov.

Vinyl Tubing

Series PV: Clear Vinyl Tubing

Series PV - Vinyl Tubing

| Part Number | Tube O.D. | | Tube I.D. | | Average Wall Thickness | | Working Pressure 73°F (23°C) | | Package Qty | Weight | |
|-------------|-----------|------|-----------|------|------------------------|-----|---------------------------------|-----|-------------|--------|----------|
| | inch | mm | inch | mm | inch | mm | psi | bar | | ft | lbs./ft. |
| PV1310-1 | 13/16 | 20.7 | .625 | 15.9 | .094 | 2.4 | 35 | 2.4 | 100 | .108 | .161 |
| PV1410-1 | 7/8 | 22.2 | .625 | 15.9 | .125 | 3.2 | 40 | 2.8 | 100 | .151 | .225 |
| PV1510-1 | 15/16 | 23.8 | .625 | 15.9 | .156 | 4.0 | 50 | 3.5 | 100 | .196 | .292 |
| PV1411-1 | 7/8 | 22.2 | .688 | 17.5 | .094 | 2.4 | 30 | 2.1 | 100 | .118 | .176 |
| PV1611-1 | 1 | 25.4 | .688 | 17.5 | .156 | 4.0 | 45 | 3.1 | 100 | .213 | .317 |
| PV1612-1 | 1 | 25.4 | .750 | 19.1 | .125 | 3.2 | 35 | 2.4 | 100 | .176 | .262 |
| PV1712-1 | 1-1/16 | 27 | .750 | 19.1 | .156 | 4.0 | 35 | 2.4 | 100 | .228 | .339 |
| PV1812-1 | 1-1/8 | 28.6 | .750 | 19.1 | .188 | 4.8 | 50 | 3.5 | 100 | .283 | .421 |
| PV2012-1 | 1-1/4 | 31.8 | .750 | 19.1 | .250 | 6.4 | 55 | 3.8 | 50 | .409 | .609 |
| PV1814-1 | 1-1/8 | 28.6 | .875 | 22.2 | .125 | 3.2 | 30 | 2.1 | 50 | .201 | .299 |
| PV1914-1 | 1-3/16 | 30.2 | .875 | 22.2 | .156 | 4.0 | 35 | 2.4 | 50 | .259 | .385 |
| PV2014-1 | 1-1/4 | 31.8 | .875 | 22.2 | .188 | 4.8 | 45 | 3.1 | 50 | .321 | .478 |
| PV2016-1 | 1-1/4 | 31.8 | 1.000 | 25.4 | .125 | 3.2 | 25 | 1.7 | 50 | .230 | .342 |
| PV2116-1 | 1-5/16 | 33.4 | 1.000 | 25.4 | .156 | 4.0 | 30 | 2.1 | 50 | .291 | .433 |
| PV2216-1 | 1-3/8 | 34.9 | 1.000 | 25.4 | .188 | 4.8 | 40 | 2.8 | 50 | .359 | .534 |
| PV2416-1 | 1-1/2 | 38.1 | 1.000 | 25.4 | .250 | 6.4 | 45 | 3.1 | 50 | .514 | .765 |
| PV2218-1 | 1-3/8 | 34.9 | 1.125 | 28.6 | .125 | 3.2 | 25 | 1.7 | 50 | .252 | .375 |
| PV2420-1 | 1-1/2 | 38.1 | 1.250 | 31.8 | .125 | 3.2 | 20 | 1.4 | 50 | .277 | .412 |
| PV2620-1 | 1-5/8 | 41.3 | 1.250 | 31.8 | .188 | 4.8 | 35 | 2.4 | 50 | .434 | .646 |
| PV2820-1 | 1-3/4 | 44.4 | 1.250 | 31.8 | .250 | 6.4 | 45 | 3.1 | 50 | .604 | .899 |
| PV3024-1 | 1-7/8 | 47.6 | 1.500 | 38.1 | .188 | 4.8 | 30 | 2.1 | 50 | .510 | .759 |
| PV3224-1 | 2 | 50.8 | 1.500 | 38.1 | .250 | 6.4 | 40 | 2.8 | 50 | .705 | 1.05 |
| PV3628-1 | 2-1/4 | 57.2 | 1.750 | 44.4 | .250 | 6.4 | 30 | 2.1 | 50 | .806 | 1.20 |
| PV4032-1 | 2-1/2 | 63.5 | 2.000 | 50.8 | .250 | 6.4 | 35 | 2.4 | 50 | .906 | 1.35 |

WARNING

This product can expose you to chemicals including Di (2-ethylhexyl) phthalate (DEHP), which is known to the State of California to cause cancer and birth defects or other reproductive harm. For more information go to www.P65Warnings.ca.gov.

PTFE Tubing

Series 101, 201: Fractional & Metric

Best chemical and corrosion resistance available.



Features

- Virgin Polytetrafluoroethylene resin
- Chemically inert
- Lowest coefficient of friction
- Superior dielectric strength
- Exceptional heat resistance
- Self extinguishing
- Non-wetting
- Excellent flexlife
- Laser markable

Compliance

- 21 CFR 177.1550 compliant
- USP Class VI compliant

Notes

- Working Temperature: -100°F (-73°C) to 500°F (260°C)
- Vacuum Rating 28 @ 73°F
- Working pressure calculated using a Design Factor of 4

PTFE Tubing (Series 101, 201) Maximum Working Pressure (psi)

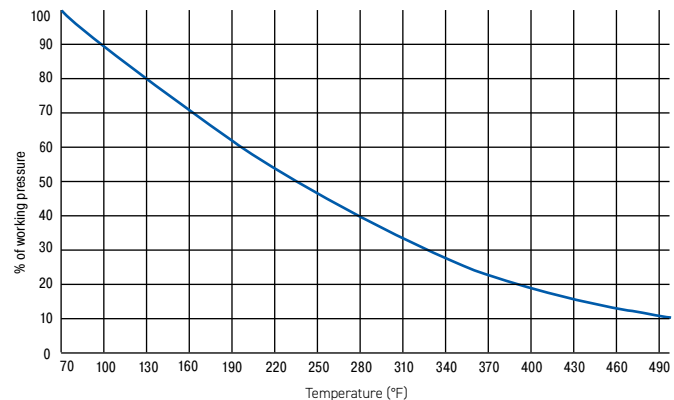

Fittings

- Parker Fittings available from:
Fluid System Connectors Division
Otsego, MI
- (269) 692-6555
(269) 692-6634 FAX
parker.com/fsc
- For approved fittings and/or suggested use of tube supports, reference Tube/Fitting Compatibility Chart (pg. B-8/B-9) or contact Parker Fluid Systems Connectors Division

Example: 101-0188062-0TC-100

101-0188062-0TC-100 – PTFE
101-0188062-0TC-100 – Tube O.D. in inches (3/16")
101-0188062-0TC-100 – Tube Wall Thickness in inches (.062")
101-0188062-0TC-100 – Black
101-0188062-0TC-100 – Bulk Tubing
101-0188062-0TC-100 – Solid Color Tube
101-0188062-0TC-100 – Package Quantity in feet (100')

WARNING

This product can expose you to chemicals including Tetrafluoroethylene, which is known to the State of California to cause cancer. For more information go to www.P65Warnings.ca.gov.

PTFE Tubing

Series 101, 201: Fractional & Metric

Series 101 - PTFE Fractional Industrial Wall Tubing

| Part Number | Order Size | Nominal O.D. | | Nominal I.D. | | Reference Wall Thickness | | Working Pressure 73°F (23°C) | | Minimum Burst Pressure | | Minimum Bend Radius | | Vac. Rating | Weight | |
|-------------|------------|--------------|-------|--------------|-------|--------------------------|------|---------------------------------|-----|------------------------|-----|---------------------|-----|-------------|---------|--------|
| | | inch | mm | inch | mm | inch | mm | psi | bar | psi | bar | inch | mm | | lb./ft. | kg./mt |
| 101-0094031 | 3/32 | 0.094 | 2.40 | 0.031 | 0.79 | 0.031 | 0.79 | 390 | 27 | 1560 | 108 | 1/2 | 13 | 28 | 0.006 | 0.009 |
| 101-0125031 | 1/8 | 0.125 | 3.18 | 0.063 | 1.57 | 0.031 | 0.79 | 290 | 20 | 1160 | 80 | 1/2 | 13 | 28 | 0.009 | 0.013 |
| 101-0156031 | 5/32 | 0.156 | 3.99 | 0.094 | 2.39 | 0.031 | 0.79 | 220 | 15 | 880 | 61 | 5/8 | 16 | 28 | 0.011 | 0.016 |
| 101-0188031 | 3/16 | 0.188 | 4.78 | 0.125 | 3.18 | 0.031 | 0.79 | 180 | 12 | 720 | 50 | 3/4 | 19 | 28 | 0.014 | 0.021 |
| 101-0250031 | 1/4 | 0.250 | 6.35 | 0.190 | 4.83 | 0.031 | 0.79 | 130 | 9 | 520 | 36 | 1 | 25 | 28 | 0.020 | 0.030 |
| 101-0312031 | 5/16 | 0.312 | 7.92 | 0.250 | 6.35 | 0.031 | 0.79 | 100 | 7 | 400 | 28 | 2-1/4 | 57 | 28 | 0.026 | 0.039 |
| 101-0375031 | 3/8 | 0.375 | 9.52 | 0.312 | 7.92 | 0.031 | 0.79 | 80 | 6 | 320 | 22 | 2-3/4 | 70 | 28 | 0.032 | 0.048 |
| 101-0438031 | 7/16 | 0.438 | 11.13 | 0.375 | 9.52 | 0.031 | 0.79 | 70 | 5 | 280 | 19 | 4 | 102 | 28 | 0.037 | 0.055 |
| 101-0500031 | 1/2 | 0.500 | 12.70 | 0.438 | 11.13 | 0.031 | 0.79 | 60 | 4 | 240 | 17 | 4 | 102 | 28 | 0.043 | 0.064 |
| 101-0563031 | 9/16 | 0.563 | 14.30 | 0.500 | 12.70 | 0.031 | 0.79 | 55 | 4 | 220 | 15 | 5 | 127 | 28 | 0.049 | 0.073 |
| 101-0625031 | 5/8 | 0.625 | 15.88 | 0.563 | 14.30 | 0.031 | 0.79 | 50 | 3 | 200 | 14 | 5-1/2 | 140 | 28 | 0.054 | 0.080 |
| 101-0688031 | 11/16 | 0.688 | 17.48 | 0.625 | 15.88 | 0.031 | 0.79 | 45 | 3 | 180 | 12 | 6-1/4 | 159 | 28 | 0.060 | 0.089 |
| 101-0750032 | 3/4 | 0.750 | 19.05 | 0.688 | 17.48 | 0.032 | 0.81 | 40 | 3 | 160 | 11 | 6-1/2 | 165 | 28 | 0.068 | 0.101 |
| 101-0830040 | 0.830 | 0.830 | 21.08 | 0.750 | 19.05 | 0.040 | 1.02 | 45 | 3 | 180 | 12 | 8 | 203 | 28 | 0.093 | 0.138 |
| 101-0965045 | 0.965 | 0.965 | 24.51 | 0.875 | 22.22 | 0.045 | 1.14 | 45 | 3 | 180 | 12 | 12 | 305 | 28 | 0.122 | 0.182 |
| 101-1100050 | 1.100 | 1.100 | 27.94 | 1.000 | 25.40 | 0.050 | 1.27 | 40 | 3 | 160 | 11 | 18 | 457 | 28 | 0.155 | 0.231 |

Series 101 - PTFE Fractional Heavy Wall Tubing

| | | | | | | | | | | | | | | | | |
|-------------|-------|-------|-------|-------|-------|-------|------|-----|-----|------|-----|-------|-----|----|-------|-------|
| 101-0188062 | 3/16 | .188 | 4.78 | 0.063 | 1.57 | 0.062 | 1.57 | 390 | 27 | 1560 | 108 | 1/4 | 6 | 28 | 0.023 | 0.034 |
| 101-0250047 | 1/4 | .250 | 6.35 | 0.157 | 3.99 | 0.047 | 1.19 | 210 | 14 | 840 | 58 | 5/8 | 16 | 28 | 0.028 | 0.042 |
| 101-0250062 | 1/4 | .250 | 6.35 | 0.125 | 3.18 | 0.062 | 1.57 | 290 | 20 | 1160 | 80 | 1/2 | 13 | 28 | 0.034 | 0.051 |
| 101-0312062 | 5/16 | .312 | 7.92 | 0.188 | 4.76 | 0.062 | 1.57 | 222 | 15 | 888 | 61 | 7/8 | 22 | 28 | 0.046 | 0.068 |
| 101-0375062 | 3/8 | .375 | 9.52 | 0.250 | 6.35 | 0.062 | 1.57 | 180 | 12 | 720 | 50 | 1 | 25 | 28 | 0.057 | 0.085 |
| 101-0438062 | 7/16 | .438 | 11.13 | 0.312 | 7.92 | 0.062 | 1.57 | 150 | 10 | 600 | 41 | 2-1/4 | 57 | 28 | 0.069 | 0.103 |
| 101-0500062 | 1/2 | .500 | 12.70 | 0.375 | 9.52 | 0.062 | 1.57 | 130 | 9 | 520 | 36 | 2-1/4 | 57 | 28 | 0.080 | 0.119 |
| 101-0563062 | 9/16 | .563 | 14.30 | 0.437 | 11.13 | 0.062 | 1.57 | 110 | 8 | 440 | 30 | 2-3/4 | 70 | 28 | 0.092 | 0.137 |
| 101-0625062 | 5/8 | .625 | 15.88 | 0.500 | 12.70 | 0.062 | 1.57 | 100 | 7 | 400 | 28 | 3 | 76 | 28 | 0.103 | 0.153 |
| 101-0688062 | 11/16 | .688 | 17.48 | 0.563 | 14.30 | 0.062 | 1.57 | 90 | 6 | 360 | 25 | 5 | 127 | 28 | 0.115 | 0.171 |
| 101-0750062 | 3/4 | .750 | 19.05 | 0.625 | 15.88 | 0.062 | 1.57 | 80 | 6 | 320 | 22 | 6 | 152 | 28 | 0.126 | 0.188 |
| 101-0875062 | 7/8 | .875 | 22.22 | 0.750 | 19.05 | 0.062 | 1.57 | 70 | 5 | 280 | 19 | 7-1/4 | 184 | 28 | 0.149 | 0.222 |
| 101-1000062 | 1 | 1.000 | 25.40 | 0.875 | 22.22 | 0.062 | 1.57 | 100 | 6.9 | 400 | 28 | 8 | 203 | 28 | 0.172 | 0.256 |

Colors

- Standard is natural
- Colors available as custom run

| Color Code | | | Color Code | | |
|------------|---|---------|------------|---|--------|
| ○ | N | Natural | ● | 5 | Green |
| ● | 0 | Black | ● | 6 | Blue |
| ● | 1 | Brown | ● | 7 | Violet |
| ● | 2 | Red | ● | 8 | Gray |
| ● | 3 | Orange | ○ | 9 | White |
| ● | 4 | Yellow | | | |



WARNING

This product can expose you to chemicals including Tetrafluoroethylene, which is known to the State of California to cause cancer. For more information go to www.P65Warnings.ca.gov.

PTFE Tubing Series 201

Series 201 - PTFE Metric Size Tubing

| Part Number | Order Size | | Nominal O.D. | | Nominal I.D. | | Reference Wall Thickness | | Working Pressure 73°F (23°C) | | Minimum Burst Pressure | | Minimum Bend Radius | | Vac. Rating | Weight | |
|-------------|------------|----|--------------|------|--------------|------|--------------------------|------|---------------------------------|-----|------------------------|-----|---------------------|------|-------------|--------|-------|
| | mm | mm | mm | inch | mm | inch | mm | inch | bar | psi | bar | psi | mm | inch | | kg/mt | lb/ft |
| 201-0300100 | 3 | 3 | 0.118 | 1 | 0.039 | 1 | 0.039 | 27 | 390 | 108 | 1560 | 13 | 1/2 | 28 | 0.014 | 0.009 | |
| 201-0400100 | 4 | 4 | 0.157 | 2 | 0.074 | 1 | 0.039 | 20 | 290 | 80 | 1160 | 13 | 1/2 | 28 | 0.020 | 0.014 | |
| 201-0500100 | 5 | 5 | 0.197 | 3 | 0.118 | 1 | 0.039 | 15 | 220 | 61 | 880 | 19 | 3/4 | 28 | 0.027 | 0.018 | |
| 201-0600100 | 6 | 6 | 0.236 | 4 | 0.157 | 1 | 0.039 | 12 | 180 | 50 | 720 | 25 | 1 | 28 | 0.034 | 0.023 | |
| 201-0700100 | 7 | 7 | 0.276 | 5 | 0.197 | 1 | 0.039 | 10 | 150 | 41 | 600 | 38 | 1-1/2 | 28 | 0.041 | 0.027 | |
| 201-0800100 | 8 | 8 | 0.315 | 6 | 0.236 | 1 | 0.039 | 9 | 130 | 36 | 520 | 51 | 2 | 28 | 0.048 | 0.032 | |
| 201-0900100 | 9 | 9 | 0.354 | 7 | 0.276 | 1 | 0.039 | 8 | 110 | 30 | 440 | 57 | 2-1/4 | 28 | 0.055 | 0.037 | |
| 201-1000100 | 10 | 10 | 0.394 | 8 | 0.315 | 1 | 0.039 | 7 | 100 | 28 | 400 | 64 | 2-1/2 | 28 | 0.061 | 0.041 | |
| 201-1200100 | 12 | 12 | 0.472 | 10 | 0.394 | 1 | 0.039 | 6 | 80 | 22 | 320 | 76 | 3 | 28 | 0.075 | 0.050 | |
| 201-1400100 | 14 | 14 | 0.551 | 12 | 0.472 | 1 | 0.039 | 5 | 70 | 19 | 280 | 89 | 3-1/2 | 28 | 0.089 | 0.060 | |
| 201-1600100 | 16 | 16 | 0.630 | 14 | 0.551 | 1 | 0.039 | 4 | 60 | 17 | 240 | 108 | 4-1/4 | 28 | 0.102 | 0.069 | |

Colors

- ○ Standard is natural
- Colors available as custom run

| Color Code | | | Color Code | | |
|------------|---|---------|------------|---|--------|
| ○ | N | Natural | ● | 5 | Green |
| ● | 0 | Black | ● | 6 | Blue |
| ● | 1 | Brown | ● | 7 | Violet |
| ● | 2 | Red | ● | 8 | Gray |
| ● | 3 | Orange | ○ | 9 | White |
| ● | 4 | Yellow | | | |

WARNING

This product can expose you to chemicals including Tetrafluoroethylene, which is known to the State of California to cause cancer. For more information go to www.P65Warnings.ca.gov.

PTFE Tubing

Series AWG TFS, TFT, TFL

Best chemical and corrosion resistance available.



Features

- Virgin Polytetrafluoroethylene resin
- Chemically inert
- Lowest coefficient of friction
- Superior dielectric strength
- Exceptional heat resistance
- Self extinguishing
- Non-wetting
- Excellent flexlife
- Laser markable

Notes

- Working Temperature: -100°F (-73°C) to 500°F (260°C)
- AWG Spaghetti tubing is supplied in 1,000 foot spools
- Custom packaging, sizes and lengths are quoted upon request

Fittings

- Parker Fittings available from:
Fluid System Connectors Division
Otsego, MI
- (269) 692-6555
(269) 692-6634 FAX
parker.com/fsc
- For approved fittings and/or suggested use of tube supports, reference Tube/Fitting Compatibility Chart (pg. B-8/B-9) or contact Parker Fluid Systems Connectors Division

Compliance

- AMS 3653G
- 21 CFR 177.1550 compliant
- USP Class VI compliant
- Light Wall (TFL) – ASTM D3295 Class 1
- Thin Wall (TFT) – ASTM D3295 Class 2, AMS 3655, CSA 9032-01 300V
- Standard Wall (TFS) – CSA 9032-01 600V

Order Information

Example: TFT13-2TC

TFT13-2TC – PTFE

TFT13-2TC – Tube Wall Thickness (Thin)

TFT13-2TC – Tube Size (AWG 13)

TFT13-2TC – Red

TFT13-2TC – Bulk Tubing

TFT13-2TC – Solid Color Tube



WARNING

This product can expose you to chemicals including Tetrafluoroethylene, which is known to the State of California to cause cancer. For more information go to www.P65Warnings.ca.gov.

PTFE Tubing Series TFH

Series TFH - PTFE AWG Heavy Wall Tubing

| Part Number | Order Size AWG | Nominal I.D. | | Minimum I.D. | | Maximum I.D. | | Nominal Wall | | Weight | | Standard Packaging |
|-------------|----------------|--------------|------|--------------|------|--------------|------|--------------|------|--------|--------|---------------------|
| | | inch | mm | inch | mm | inch | mm | inch | mm | lb/ft | kg/mtr | |
| TFH24 | 24 | 0.022 | 0.56 | 0.020 | 0.51 | 0.026 | 0.66 | 0.016 | 0.41 | 0.0018 | 0.0027 | 1,000 ft. spool |
| TFH23 | 23 | 0.026 | 0.66 | 0.023 | 0.58 | 0.029 | 0.74 | 0.016 | 0.41 | 0.0020 | 0.0030 | 1,000 ft. spool |
| TFH22 | 22 | 0.028 | 0.71 | 0.025 | 0.64 | 0.032 | 0.81 | 0.016 | 0.41 | 0.0021 | 0.0031 | 1,000 ft. spool |
| TFH21 | 21 | 0.032 | 0.81 | 0.029 | 0.74 | 0.035 | 0.89 | 0.016 | 0.41 | 0.0022 | 0.0033 | 1,000 ft. spool |
| TFH20 | 20 | 0.034 | 0.86 | 0.032 | 0.81 | 0.040 | 1.02 | 0.018 | 0.46 | 0.0027 | 0.0040 | 1,000 ft. spool |
| TFH19 | 19 | 0.038 | 0.97 | 0.036 | 0.91 | 0.044 | 1.12 | 0.020 | 0.51 | 0.0034 | 0.0051 | 1,000 ft. spool |
| TFH18 | 18 | 0.042 | 1.07 | 0.040 | 1.02 | 0.049 | 1.25 | 0.020 | 0.51 | 0.0036 | 0.0054 | 1,000 ft. spool |
| TFH17 | 17 | 0.048 | 1.22 | 0.045 | 1.14 | 0.054 | 1.37 | 0.020 | 0.51 | 0.0040 | 0.0060 | 1,000 ft. spool |
| TFH16 | 16 | 0.053 | 1.35 | 0.051 | 1.3 | 0.061 | 1.55 | 0.020 | 0.51 | 0.0043 | 0.0064 | 1,000 ft. spool |
| TFH15 | 15 | 0.059 | 1.50 | 0.057 | 1.45 | 0.067 | 1.70 | 0.020 | 0.51 | 0.0046 | 0.0068 | 1,000 ft. spool |
| TFH14 | 14 | 0.066 | 1.68 | 0.064 | 1.63 | 0.074 | 1.88 | 0.020 | 0.51 | 0.0050 | 0.0074 | 500 ft. spool |
| TFH13 | 13 | 0.076 | 1.93 | 0.072 | 1.83 | 0.082 | 2.08 | 0.020 | 0.51 | 0.0056 | 0.0083 | 500 ft. spool |
| TFH12 | 12 | 0.085 | 2.16 | 0.081 | 2.06 | 0.091 | 2.31 | 0.020 | 0.51 | 0.0061 | 0.0091 | 500 ft. spool |
| TFH11 | 11 | 0.095 | 2.41 | 0.091 | 2.31 | 0.101 | 2.57 | 0.020 | 0.51 | 0.0067 | 0.0100 | 500 ft. spool |
| TFH10 | 10 | 0.106 | 2.69 | 0.102 | 2.59 | 0.112 | 2.84 | 0.025 | 0.64 | 0.0096 | 0.0143 | 500 ft. spool |
| TFH09 | 9 | 0.118 | 3.00 | 0.114 | 2.90 | 0.124 | 3.15 | 0.025 | 0.64 | 0.0105 | 0.0156 | 500 ft. spool |
| TFH08 | 8 | 0.133 | 3.38 | 0.129 | 3.28 | 0.141 | 3.58 | 0.030 | 0.76 | 0.0143 | 0.0213 | random length coils |
| TFH07 | 7 | 0.148 | 3.76 | 0.144 | 3.66 | 0.158 | 4.01 | 0.030 | 0.76 | 0.0156 | 0.0232 | random length coils |
| TFH06 | 6 | 0.166 | 4.22 | 0.162 | 4.11 | 0.178 | 4.52 | 0.030 | 0.76 | 0.0172 | 0.0256 | random length coils |
| TFH05 | 5 | 0.185 | 4.70 | 0.182 | 4.62 | 0.196 | 4.98 | 0.032 | 0.81 | 0.0203 | 0.0302 | random length coils |

Colors

- Standard is natural
- Colors available as custom run

| Color Code | | | Color Code | | |
|------------|---|---------|------------|---|--------|
| ○ | N | Natural | ● | 5 | Green |
| ● | 0 | Black | ● | 6 | Blue |
| ● | 1 | Brown | ● | 7 | Violet |
| ● | 2 | Red | ● | 8 | Gray |
| ● | 3 | Orange | ○ | 9 | White |
| ● | 4 | Yellow | | | |

WARNING

This product can expose you to chemicals including Tetrafluoroethylene, which is known to the State of California to cause cancer. For more information go to www.P65Warnings.ca.gov.

PTFE Tubing Series TFS

Series TFS - PTFE AWG Standard Wall Tubing

| Part Number | Order Size AWG | Nominal I.D. | | Minimum I.D. | | Maximum I.D. | | Nominal Wall | | Weight | | Standard Packaging |
|-------------|----------------|--------------|------|--------------|------|--------------|------|--------------|------|--------|--------|---------------------|
| | | inch | mm | inch | mm | inch | mm | inch | mm | lb/ft | kg/mtr | |
| TFS30 | 30 | 0.012 | 0.31 | 0.010 | 0.25 | 0.015 | 0.38 | 0.009 | 0.23 | 0.0006 | 0.0009 | 1,000 ft. spool |
| TFS28 | 28 | 0.015 | 0.38 | 0.013 | 0.33 | 0.018 | 0.46 | 0.009 | 0.23 | 0.0006 | 0.0009 | 1,000 ft. spool |
| TFS26 | 26 | 0.018 | 0.46 | 0.016 | 0.41 | 0.022 | 0.56 | 0.009 | 0.23 | 0.0007 | 0.0010 | 1,000 ft. spool |
| TFS24 | 24 | 0.022 | 0.56 | 0.020 | 0.51 | 0.026 | 0.66 | 0.012 | 0.31 | 0.0012 | 0.0018 | 1,000 ft. spool |
| TFS23 | 23 | 0.026 | 0.66 | 0.023 | 0.58 | 0.029 | 0.74 | 0.012 | 0.31 | 0.0013 | 0.0019 | 1,000 ft. spool |
| TFS22 | 22 | 0.028 | 0.71 | 0.025 | 0.64 | 0.032 | 0.81 | 0.012 | 0.31 | 0.0014 | 0.0021 | 1,000 ft. spool |
| TFS21 | 21 | 0.032 | 0.81 | 0.029 | 0.74 | 0.035 | 0.89 | 0.012 | 0.31 | 0.0015 | 0.0022 | 1,000 ft. spool |
| TFS20 | 20 | 0.034 | 0.86 | 0.032 | 0.81 | 0.040 | 1.02 | 0.016 | 0.41 | 0.0023 | 0.0034 | 1,000 ft. spool |
| TFS19 | 19 | 0.038 | 0.97 | 0.036 | 0.91 | 0.044 | 1.12 | 0.016 | 0.41 | 0.0025 | 0.0037 | 1,000 ft. spool |
| TFS18 | 18 | 0.042 | 1.07 | 0.040 | 1.02 | 0.049 | 1.25 | 0.016 | 0.41 | 0.0270 | 0.0402 | 1,000 ft. spool |
| TFS17 | 17 | 0.048 | 1.22 | 0.045 | 1.14 | 0.054 | 1.37 | 0.016 | 0.41 | 0.0030 | 0.0045 | 1,000 ft. spool |
| TFS16 | 16 | 0.053 | 1.35 | 0.051 | 1.30 | 0.061 | 1.55 | 0.016 | 0.41 | 0.0032 | 0.0048 | 1,000 ft. spool |
| TFS15 | 15 | 0.059 | 1.50 | 0.057 | 1.45 | 0.067 | 1.70 | 0.016 | 0.41 | 0.0059 | 0.0088 | 500 ft. spool |
| TFS14 | 14 | 0.066 | 1.68 | 0.064 | 1.63 | 0.074 | 1.88 | 0.016 | 0.41 | 0.0038 | 0.0057 | 500 ft. spool |
| TFS13 | 13 | 0.076 | 1.93 | 0.072 | 1.83 | 0.082 | 2.08 | 0.016 | 0.41 | 0.0043 | 0.0064 | 500 ft. spool |
| TFS12 | 12 | 0.085 | 2.16 | 0.081 | 2.06 | 0.091 | 2.31 | 0.016 | 0.41 | 0.0047 | 0.0070 | 500 ft. spool |
| TFS11 | 11 | 0.095 | 2.41 | 0.091 | 2.31 | 0.101 | 2.57 | 0.016 | 0.41 | 0.0052 | 0.0077 | 500 ft. spool |
| TFS10 | 10 | 0.106 | 2.69 | 0.102 | 2.59 | 0.112 | 2.84 | 0.016 | 0.41 | 0.0057 | 0.0085 | 500 ft. spool |
| TFS09 | 9 | 0.118 | 3.00 | 0.114 | 2.90 | 0.124 | 3.15 | 0.020 | 0.51 | 0.0081 | 0.0121 | 500 ft. spool |
| TFS08 | 8 | 0.133 | 3.38 | 0.129 | 3.28 | 0.141 | 3.58 | 0.020 | 0.51 | 0.0090 | 0.0134 | random length coils |
| TFS07 | 7 | 0.148 | 3.76 | 0.144 | 3.66 | 0.158 | 4.01 | 0.020 | 0.51 | 0.0098 | 0.0146 | random length coils |
| TFS06 | 6 | 0.166 | 4.22 | 0.162 | 4.11 | 0.178 | 4.52 | 0.020 | 0.51 | 0.0109 | 0.0162 | random length coils |
| TFS05 | 5 | 0.185 | 4.70 | 0.182 | 4.62 | 0.196 | 4.98 | 0.020 | 0.51 | 0.0120 | 0.0179 | random length coils |
| TFS04 | 4 | 0.208 | 5.28 | 0.204 | 5.18 | 0.224 | 5.69 | 0.020 | 0.51 | 0.0133 | 0.0198 | random length coils |
| TFS03 | 3 | 0.234 | 5.94 | 0.229 | 5.82 | 0.249 | 6.32 | 0.020 | 0.51 | 0.0149 | 0.0222 | random length coils |
| TFS02 | 2 | 0.263 | 6.68 | 0.258 | 6.55 | 0.278 | 7.06 | 0.020 | 0.51 | 0.0166 | 0.0247 | random length coils |
| TFS01 | 1 | 0.294 | 7.47 | 0.289 | 7.34 | 0.311 | 7.90 | 0.020 | 0.51 | 0.0184 | 0.0274 | random length coils |
| TFS00 | 0 | 0.330 | 8.38 | 0.325 | 8.25 | 0.347 | 8.81 | 0.020 | 0.51 | 0.0205 | 0.0305 | random length coils |

Colors

- Standard is natural
- Colors available as custom run

| Color Code | | | Color Code | | |
|------------|---|---------|------------|---|--------|
| ○ | N | Natural | ● | 5 | Green |
| ● | 0 | Black | ● | 6 | Blue |
| ● | 1 | Brown | ● | 7 | Violet |
| ● | 2 | Red | ● | 8 | Gray |
| ● | 3 | Orange | ○ | 9 | White |
| ● | 4 | Yellow | | | |



WARNING

This product can expose you to chemicals including Tetrafluoroethylene, which is known to the State of California to cause cancer. For more information go to www.P65Warnings.ca.gov.

PTFE Tubing Series TFT

Series TFT - PTFE AWG Thin Wall Tubing

| Part Number | Order Size AWG | Nominal I.D. | | Minimum I.D. | | Maximum I.D. | | Nominal Wall | | Weight | | Standard Packaging |
|-------------|----------------|--------------|------|--------------|------|--------------|------|--------------|------|--------|--------|---------------------|
| | | inch | mm | inch | mm | inch | mm | inch | mm | lb/ft | kg/mtr | |
| TFT32 | 32 | 0.010 | 0.25 | 0.008 | 0.20 | 0.012 | 0.31 | 0.007 | 0.18 | 0.0003 | 0.0004 | 1,000 ft. spool |
| TFT30 | 30 | 0.012 | 0.31 | 0.010 | 0.25 | 0.015 | 0.38 | 0.009 | 0.23 | 0.0006 | 0.0009 | 1,000 ft. spool |
| TFT28 | 28 | 0.015 | 0.38 | 0.013 | 0.33 | 0.018 | 0.46 | 0.009 | 0.23 | 0.0006 | 0.0009 | 1,000 ft. spool |
| TFT26 | 26 | 0.018 | 0.46 | 0.016 | 0.41 | 0.022 | 0.56 | 0.009 | 0.23 | 0.0007 | 0.0010 | 1,000 ft. spool |
| TFT24 | 24 | 0.022 | 0.56 | 0.02 | 0.51 | 0.026 | 0.66 | 0.010 | 0.25 | 0.0009 | 0.0013 | 1,000 ft. spool |
| TFT23 | 23 | 0.026 | 0.66 | 0.023 | 0.58 | 0.029 | 0.74 | 0.010 | 0.25 | 0.0011 | 0.0016 | 1,000 ft. spool |
| TFT22 | 22 | 0.028 | 0.71 | 0.025 | 0.64 | 0.032 | 0.81 | 0.010 | 0.25 | 0.0011 | 0.0016 | 1,000 ft. spool |
| TFT21 | 21 | 0.032 | 0.81 | 0.029 | 0.74 | 0.035 | 0.89 | 0.010 | 0.25 | 0.0012 | 0.0018 | 1,000 ft. spool |
| TFT20 | 20 | 0.034 | 0.86 | 0.032 | 0.81 | 0.040 | 1.02 | 0.012 | 0.31 | 0.0016 | 0.0024 | 1,000 ft. spool |
| TFT19 | 19 | 0.038 | 0.97 | 0.036 | 0.91 | 0.044 | 1.12 | 0.012 | 0.31 | 0.0018 | 0.0027 | 1,000 ft. spool |
| TFT18 | 18 | 0.042 | 1.07 | 0.040 | 1.02 | 0.049 | 1.25 | 0.012 | 0.31 | 0.0019 | 0.0028 | 1,000 ft. spool |
| TFT17 | 17 | 0.048 | 1.22 | 0.045 | 1.14 | 0.054 | 1.37 | 0.012 | 0.31 | 0.0021 | 0.0031 | 1,000 ft. spool |
| TFT16 | 16 | 0.053 | 1.35 | 0.051 | 1.30 | 0.061 | 1.55 | 0.012 | 0.31 | 0.0023 | 0.0034 | 1,000 ft. spool |
| TFT15 | 15 | 0.059 | 1.50 | 0.057 | 1.45 | 0.067 | 1.70 | 0.012 | 0.31 | 0.0025 | 0.0037 | 1,000 ft. spool |
| TFT14 | 14 | 0.066 | 1.68 | 0.064 | 1.63 | 0.074 | 1.88 | 0.012 | 0.31 | 0.0027 | 0.0040 | 500 ft. spool |
| TFT13 | 13 | 0.076 | 1.93 | 0.072 | 1.83 | 0.082 | 2.08 | 0.012 | 0.31 | 0.0031 | 0.0046 | 500 ft. spool |
| TFT12 | 12 | 0.085 | 2.16 | 0.081 | 2.06 | 0.091 | 2.31 | 0.012 | 0.31 | 0.0034 | 0.0051 | 500 ft. spool |
| TFT11 | 11 | 0.095 | 2.41 | 0.091 | 2.31 | 0.101 | 2.57 | 0.012 | 0.31 | 0.0038 | 0.0057 | 500 ft. spool |
| TFT10 | 10 | 0.106 | 2.69 | 0.102 | 2.59 | 0.112 | 2.84 | 0.012 | 0.31 | 0.0041 | 0.0061 | 500 ft. spool |
| TFT09 | 9 | 0.118 | 3.00 | 0.114 | 2.9 | 0.124 | 3.15 | 0.015 | 0.38 | 0.0058 | 0.0086 | 500 ft. spool |
| TFT08 | 8 | 0.133 | 3.38 | 0.129 | 3.28 | 0.141 | 3.58 | 0.015 | 0.38 | 0.0065 | 0.0097 | random length coils |
| TFT07 | 7 | 0.148 | 3.76 | 0.144 | 3.66 | 0.158 | 4.01 | 0.015 | 0.38 | 0.0072 | 0.0107 | random length coils |
| TFT06 | 6 | 0.166 | 4.22 | 0.162 | 4.11 | 0.178 | 4.52 | 0.015 | 0.38 | 0.0079 | 0.0118 | random length coils |
| TFT05 | 5 | 0.185 | 4.70 | 0.182 | 4.62 | 0.196 | 4.98 | 0.015 | 0.38 | 0.0088 | 0.0131 | random length coils |
| TFT04 | 4 | 0.208 | 5.28 | 0.204 | 5.18 | 0.224 | 5.69 | 0.015 | 0.38 | 0.0098 | 0.0146 | random length coils |
| TFT03 | 3 | 0.234 | 5.94 | 0.229 | 5.82 | 0.249 | 6.32 | 0.015 | 0.38 | 0.0109 | 0.0162 | random length coils |
| TFT02 | 2 | 0.263 | 6.68 | 0.258 | 6.55 | 0.278 | 7.06 | 0.015 | 0.38 | 0.0122 | 0.0182 | random length coils |
| TFT01 | 1 | 0.294 | 7.47 | 0.289 | 7.34 | 0.311 | 7.90 | 0.015 | 0.38 | 0.0136 | 0.0202 | random length coils |
| TFT00 | 0 | 0.330 | 8.38 | 0.325 | 8.25 | 0.347 | 8.81 | 0.015 | 0.38 | 0.0151 | 0.0225 | random length coils |

Colors

- Standard is natural
- Colors available as custom run

| Color Code | | | Color Code | | |
|------------|---|---------|------------|---|--------|
| ○ | N | Natural | ● | 5 | Green |
| ● | 0 | Black | ● | 6 | Blue |
| ● | 1 | Brown | ● | 7 | Violet |
| ● | 2 | Red | ● | 8 | Gray |
| ● | 3 | Orange | ○ | 9 | White |
| ● | 4 | Yellow | | | |



WARNING

This product can expose you to chemicals including Tetrafluoroethylene, which is known to the State of California to cause cancer. For more information go to www.P65Warnings.ca.gov.

PTFE Tubing Series TFL

Series TFL - PTFE AWG Light Wall Tubing

| Part Number | Order Size AWG | Nominal I.D. | | Minimum I.D. | | Maximum I.D. | | Nominal Wall | | Weight | | Standard Packaging |
|-------------|----------------|--------------|------|--------------|------|--------------|------|--------------|------|--------|--------|---------------------|
| | | inch | mm | inch | mm | inch | mm | inch | mm | lb/ft | kg/mtr | |
| TFL32 | 32 | 0.010 | 0.25 | 0.008 | 0.20 | 0.012 | 0.31 | 0.005 | 0.13 | 0.0002 | 0.0003 | 1,000 ft. spool |
| TFL30 | 30 | 0.012 | 0.31 | 0.010 | 0.25 | 0.015 | 0.38 | 0.006 | 0.13 | 0.0003 | 0.0004 | 1,000 ft. spool |
| TFL28 | 28 | 0.015 | 0.38 | 0.013 | 0.33 | 0.018 | 0.46 | 0.006 | 0.13 | 0.0004 | 0.0006 | 1,000 ft. spool |
| TFL26 | 26 | 0.018 | 0.46 | 0.016 | 0.41 | 0.022 | 0.56 | 0.006 | 0.13 | 0.0004 | 0.0006 | 1,000 ft. spool |
| TFL24 | 24 | 0.022 | 0.56 | 0.020 | 0.51 | 0.026 | 0.66 | 0.006 | 0.13 | 0.0005 | 0.0007 | 1,000 ft. spool |
| TFL23 | 23 | 0.026 | 0.66 | 0.023 | 0.58 | 0.029 | 0.74 | 0.006 | 0.13 | 0.0006 | 0.0009 | 1,000 ft. spool |
| TFL22 | 22 | 0.028 | 0.71 | 0.025 | 0.64 | 0.032 | 0.81 | 0.006 | 0.13 | 0.0006 | 0.0009 | 1,000 ft. spool |
| TFL21 | 21 | 0.032 | 0.81 | 0.029 | 0.74 | 0.035 | 0.89 | 0.006 | 0.13 | 0.0007 | 0.0010 | 1,000 ft. spool |
| TFL20 | 20 | 0.034 | 0.86 | 0.032 | 0.81 | 0.040 | 1.02 | 0.006 | 0.13 | 0.0007 | 0.0010 | 1,000 ft. spool |
| TFL19 | 19 | 0.038 | 0.97 | 0.036 | 0.91 | 0.044 | 1.12 | 0.006 | 0.13 | 0.0008 | 0.0012 | 1,000 ft. spool |
| TFL18 | 18 | 0.042 | 1.07 | 0.040 | 1.02 | 0.049 | 1.25 | 0.006 | 0.13 | 0.0008 | 0.0012 | 1,000 ft. spool |
| TFL17 | 17 | 0.048 | 1.22 | 0.045 | 1.14 | 0.054 | 1.37 | 0.006 | 0.13 | 0.0009 | 0.0013 | 1,000 ft. spool |
| TFL16 | 16 | 0.053 | 1.35 | 0.051 | 1.30 | 0.061 | 1.55 | 0.006 | 0.13 | 0.0010 | 0.0015 | 1,000 ft. spool |
| TFL15 | 15 | 0.059 | 1.50 | 0.057 | 1.45 | 0.067 | 1.70 | 0.006 | 0.13 | 0.0011 | 0.0016 | 1,000 ft. spool |
| TFL14 | 14 | 0.066 | 1.68 | 0.064 | 1.63 | 0.074 | 1.88 | 0.008 | 0.20 | 0.0017 | 0.0025 | 500 ft. spool |
| TFL13 | 13 | 0.076 | 1.93 | 0.072 | 1.83 | 0.082 | 2.08 | 0.008 | 0.20 | 0.0020 | 0.0030 | 500 ft. spool |
| TFL12 | 12 | 0.085 | 2.16 | 0.081 | 2.06 | 0.091 | 2.31 | 0.008 | 0.20 | 0.0022 | 0.0033 | 500 ft. spool |
| TFL11 | 11 | 0.095 | 2.41 | 0.091 | 2.31 | 0.101 | 2.57 | 0.008 | 0.20 | 0.0024 | 0.0036 | 500 ft. spool |
| TFL10 | 10 | 0.106 | 2.69 | 0.102 | 2.59 | 0.112 | 2.84 | 0.008 | 0.20 | 0.0027 | 0.0040 | 500 ft. spool |
| TFL09 | 9 | 0.118 | 3.00 | 0.114 | 2.90 | 0.124 | 3.15 | 0.008 | 0.20 | 0.0030 | 0.0045 | 500 ft. spool |
| TFL08 | 8 | 0.133 | 3.38 | 0.129 | 3.28 | 0.141 | 3.58 | 0.008 | 0.20 | 0.0033 | 0.0049 | random length coils |
| TFL07 | 7 | 0.148 | 3.76 | 0.144 | 3.66 | 0.158 | 4.01 | 0.008 | 0.20 | 0.0037 | 0.0055 | random length coils |
| TFL06 | 6 | 0.166 | 4.22 | 0.162 | 4.11 | 0.178 | 4.52 | 0.010 | 0.25 | 0.0052 | 0.0077 | random length coils |
| TFL05 | 5 | 0.185 | 4.70 | 0.182 | 4.62 | 0.196 | 4.98 | 0.010 | 0.25 | 0.0057 | 0.0085 | random length coils |
| TFL04 | 4 | 0.208 | 5.28 | 0.204 | 5.18 | 0.224 | 5.69 | 0.010 | 0.25 | 0.0064 | 0.0095 | random length coils |
| TFL03 | 3 | 0.234 | 5.94 | 0.229 | 5.82 | 0.249 | 6.32 | 0.010 | 0.25 | 0.0071 | 0.0106 | random length coils |
| TFL02 | 2 | 0.263 | 6.68 | 0.258 | 6.55 | 0.278 | 7.06 | 0.010 | 0.25 | 0.0080 | 0.0119 | random length coils |
| TFL01 | 1 | 0.294 | 7.47 | 0.289 | 7.34 | 0.311 | 7.90 | 0.012 | 0.31 | 0.0107 | 0.0159 | random length coils |
| TFL00 | 0 | 0.330 | 8.38 | 0.325 | 8.25 | 0.347 | 8.81 | 0.012 | 0.31 | 0.0120 | 0.0179 | random length coils |

Colors

- Standard is natural
- Colors available as custom run

| Color Code | | | Color Code | | |
|------------|---|---------|------------|---|--------|
| ○ | N | Natural | ● | 5 | Green |
| ● | 0 | Black | ● | 6 | Blue |
| ● | 1 | Brown | ● | 7 | Violet |
| ● | 2 | Red | ● | 8 | Gray |
| ● | 3 | Orange | ○ | 9 | White |
| ● | 4 | Yellow | | | |



WARNING

This product can expose you to chemicals including Tetrafluoroethylene, which is known to the State of California to cause cancer. For more information go to www.P65Warnings.ca.gov.

PTFE Beading Series TFB

Heat resistant beading is a solid profile; ideal for electrical applications.



Features

- Virgin Polytetrafluoroethylene resin
- Chemically inert
- Lowest coefficient of friction
- Superior dielectric strength
- Exceptional heat resistance
- Self extinguishing
- Non-wetting
- Excellent flexlife
- Laser markable

Compliance

- ASTM D1710, Type 1, Grade 1, Class B
- ASTM D3295
- 21 CFR 177.1550 compliant
- USP Class VI compliant

Notes

- Working Temperature: -100°F (-73°C) to 500°F (260°C)
- Vacuum Rating 28 @ 73°F
- Working pressure calculated using a Design Factor of 4

Colors

- Standard is natural
- Colors available as custom run

| Color Code | | | Color Code | | |
|----------------------------------|---|---------|----------------------------------|---|--------|
| <input type="radio"/> | N | Natural | <input checked="" type="radio"/> | 5 | Green |
| <input checked="" type="radio"/> | 0 | Black | <input checked="" type="radio"/> | 6 | Blue |
| <input checked="" type="radio"/> | 1 | Brown | <input checked="" type="radio"/> | 7 | Violet |
| <input checked="" type="radio"/> | 2 | Red | <input checked="" type="radio"/> | 8 | Gray |
| <input checked="" type="radio"/> | 3 | Orange | <input type="radio"/> | 9 | White |
| <input checked="" type="radio"/> | 4 | Yellow | | | |

Order Information

Example: TFB028-NT

TFB028-NT – PTFE Beading

TFB028-NT – Beading O.D. in inches (0.028")

TFB028-NT – Natural

TFB028-NT – Bulk Tubing

WARNING

This product can expose you to chemicals including Tetrafluoroethylene, which is known to the State of California to cause cancer. For more information go to www.P65Warnings.ca.gov.

PTFE Beading Series TFB

Series TFB - PTFE Beading (Solid Tube)

| Part Number | Diameter | | Tolerance | | Weight | | Standard Packaging |
|-------------|----------|------|-----------|--------|--------|--------|--------------------|
| | inch | mm | inch | mm | lb/ft | kg/mtr | |
| TFB015 | 0.015 | 0.38 | ± 0.002 | ± 0.05 | 0.0002 | 0.0003 | 1,000 ft. Spool |
| TFB020 | 0.020 | 0.51 | ± 0.002 | ± 0.05 | 0.0003 | 0.0004 | 1,000 ft. Spool |
| TFB025 | 0.025 | 0.64 | ± 0.002 | ± 0.05 | 0.0005 | 0.0007 | 1,000 ft. Spool |
| TFB028 | 0.028 | 0.71 | ± 0.002 | ± 0.05 | 0.0006 | 0.0009 | 1,000 ft. Spool |
| TFB031 | 0.031 | 0.79 | ± 0.002 | ± 0.05 | 0.0007 | 0.0010 | 1,000 ft. Spool |
| TFB035 | 0.035 | 0.89 | ± 0.002 | ± 0.05 | 0.0009 | 0.0013 | 1,000 ft. Spool |
| TFB039 | 0.039 | 0.99 | ± 0.002 | ± 0.05 | 0.0011 | 0.0016 | 1,000 ft. Spool |
| TFB043 | 0.043 | 1.09 | ± 0.002 | ± 0.05 | 0.0014 | 0.0021 | 1,000 ft. Spool |
| TFB047 | 0.047 | 1.19 | ± 0.002 | ± 0.05 | 0.0016 | 0.0024 | 1,000 ft. Spool |
| TFB050 | 0.050 | 1.27 | ± 0.002 | ± 0.05 | 0.0018 | 0.0027 | 1,000 ft. Spool |
| TFB055 | 0.055 | 1.40 | ± 0.003 | ± 0.08 | 0.0022 | 0.0033 | 1,000 ft. Spool |
| TFB060 | 0.060 | 1.52 | ± 0.003 | ± 0.08 | 0.0026 | 0.0039 | 1,000 ft. Spool |
| TFB062 | 0.062 | 1.57 | ± 0.003 | ± 0.08 | 0.0028 | 0.0042 | 1,000 ft. Spool |
| TFB070 | 0.070 | 1.78 | ± 0.003 | ± 0.08 | 0.0036 | 0.0054 | 1,000 ft. Spool |
| TFB072 | 0.072 | 1.83 | ± 0.003 | ± 0.08 | 0.0038 | 0.0057 | 1,000 ft. Spool |
| TFB078 | 0.078 | 1.98 | ± 0.004 | ± 0.10 | 0.0045 | 0.0067 | 500 ft. Spool |
| TFB080 | 0.080 | 2.03 | ± 0.004 | ± 0.10 | 0.0047 | 0.0070 | 500 ft. Spool |
| TFB084 | 0.084 | 2.13 | ± 0.004 | ± 0.10 | 0.0052 | 0.0077 | 500 ft. Spool |
| TFB090 | 0.090 | 2.29 | ± 0.004 | ± 0.10 | 0.0059 | 0.0088 | 500 ft. Spool |
| TFB094 | 0.094 | 2.39 | ± 0.004 | ± 0.10 | 0.0065 | 0.0097 | 500 ft. Spool |
| TFB100 | 0.100 | 2.54 | ± 0.004 | ± 0.10 | 0.0073 | 0.0109 | 500 ft. Spool |
| TFB109 | 0.109 | 2.77 | ± 0.004 | ± 0.10 | 0.0087 | 0.0129 | 500 ft. Spool |
| TFB115 | 0.115 | 2.92 | ± 0.004 | ± 0.10 | 0.0097 | 0.0144 | 500 ft. Spool |
| TFB125 | 0.125 | 3.18 | ± 0.004 | ± 0.10 | 0.0114 | 0.0170 | Random Length |
| TFB150 | 0.150 | 3.81 | ± 0.004 | ± 0.10 | 0.0165 | 0.0246 | Random Length |
| TFB188 | 0.188 | 4.78 | ± 0.004 | ± 0.10 | 0.0259 | 0.0385 | Random Length |



WARNING

This product can expose you to chemicals including Tetrafluoroethylene, which is known to the State of California to cause cancer. For more information go to www.P65Warnings.ca.gov.

PTFE Spiral Cut Tubing Series TSWTF

High temperature harnessing for wires and cables.

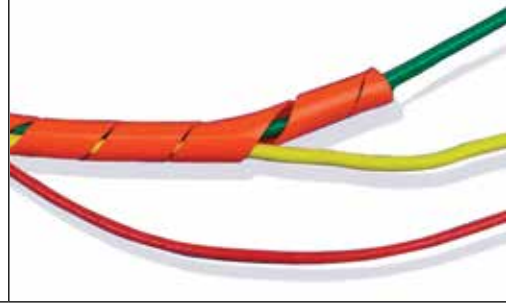

Features

- Provides harnessing for wires and cable while allowing leads at various points
- Exceptional heat resistance
- Self extinguishing
- Flexible
- Superior dielectric strength

Compliance

- ASTM D3295

Notes

- Working Temperature: -100°F (-73°C) to 500°F (260°C)
- Available in left- or right-hand cut. Please specify with proper suffix at end of part number (i.e. TSWTF-1/8-R)

Colors

- ○ Standard is natural
- Colors available as custom run

| Color Code | | | Color Code | | |
|------------|---|---------|------------|---|--------|
| ○ | N | Natural | ● | 5 | Green |
| ● | 0 | Black | ● | 6 | Blue |
| ● | 1 | Brown | ● | 7 | Violet |
| ● | 2 | Red | ● | 8 | Gray |
| ● | 3 | Orange | ○ | 9 | White |
| ● | 4 | Yellow | | | |

Order Information

Example: TSWTF-3/8-5TC-R

TSWTF-3/8-5TC-R – Spiral Wrap Tubing

TSWTF-3/8-5TC-R – PTFE

TSWTF-3/8-5TC-R – Tube O.D. in inches (3/8")

TSWTF-3/8-5TC-R – Green

TSWTF-3/8-5TC-R – Bulk Tubing

TSWTF-3/8-5TC-R – Solid Color

TSWTF-3/8-5TC-R – Right Hand Cut Spiral



WARNING

This product can expose you to chemicals including Tetrafluoroethylene, which is known to the State of California to cause cancer. For more information go to www.P65Warnings.ca.gov.

PTFE Spiral Cut Tubing Series TSWTF

Series TSWTF - PTFE Spiral Cut Tubing

| Part Number | Nominal O.D. "A" | | Wall Thickness "B" | | Pitch "D" | | Pitch Tolerance | | Maximum Bundle O.D. "C" | | Weight | |
|---------------|------------------|------|--------------------|-------|-----------|-------|-----------------|-------|-------------------------|-------|--------|--------|
| | inch | mm | inch | mm | inch | mm | psi | bar | inch | mm | lb/ft | kg/mtr |
| TSWTF-1/8-NT | 0.125 | 3.18 | 0.020 | 0.508 | 0.212 | 5.38 | ± 0.015 | 0.381 | 1/2 | 12.7 | 0.0061 | 0.0091 |
| TSWTF-3/16-NT | 0.188 | 4.78 | 0.030 | 0.762 | 0.312 | 7.92 | ± 0.015 | 0.381 | 1 | 25.4 | 0.0142 | 0.0211 |
| TSWTF-1/4-NT | 0.250 | 6.35 | 0.030 | 0.762 | 0.375 | 9.52 | ± 0.015 | 0.381 | 2 | 50.8 | 0.0085 | 0.0126 |
| TSWTF-3/8-NT | 0.375 | 9.52 | 0.030 | 0.762 | 0.437 | 11.1 | ± 0.015 | 0.381 | 2-1/2 | 63.5 | 0.0317 | 0.0472 |
| TSWTF-1/2-NT | 0.500 | 12.7 | 0.030 | 0.762 | 0.562 | 14.27 | ± 0.015 | 0.381 | 3 | 76.2 | 0.0426 | 0.0634 |
| TSWTF-3/4-NT | 0.75 | 19.1 | 0.040 | 1.02 | 0.875 | 22.22 | ± 0.015 | 0.381 | 4 | 101.6 | 0.0831 | 0.1237 |
| TSWTF-1.00-NT | 1 | 25.4 | 0.040 | 1.02 | 1 | 25.4 | ± 0.015 | 0.381 | 6 | 152.4 | 0.1124 | 0.1673 |

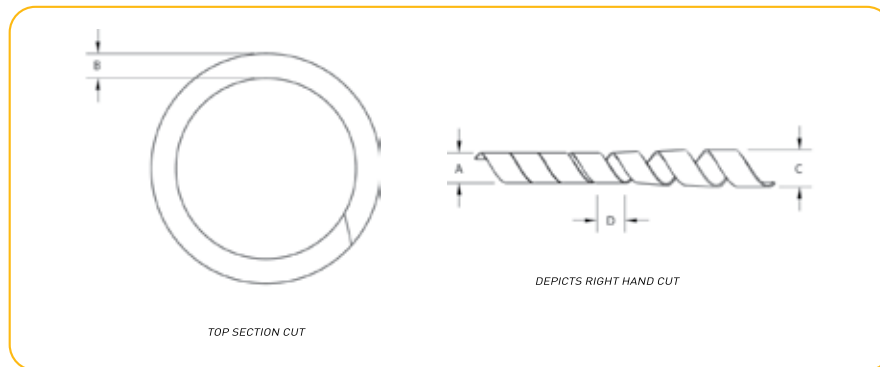

WARNING

This product can expose you to chemicals including Tetrafluoroethylene, which is known to the State of California to cause cancer. For more information go to www.P65Warnings.ca.gov.

PTFE Heat Shrinkable Tubing

Series HS2TFS, HS2TFT, HS2TFL, HS2TFI, HS4TFI

Supplied expanded, allowing easy slippage over instruments, fittings and other protrusions.

2:1 Heat Shrink Ratio
4:1 Heat Shrink Ratio



Features

- Virgin Polytetrafluoroethylene resin
- 2:1 Shrink Ratio
- Chemically inert
- Lowest coefficient of friction
- Superior dielectric strength
- Exceptional heat resistance
- Self extinguishing
- Non-wetting

Compliance

- ASTM 2902 Type I
- 21 CFR 177.1550 compliant
- USP Class VI
- AS23053/12

Notes

- Working Temperature: -100°F (-73°C) to 500°F (260°C)
- Shrink Temperature: 662°F (350°C) for 10 minutes per AMS-DTL-23053/12A
- *Dielectric Strength: > 800 v/m, per ASTM D 149 short term test of 10 MIL thickness (volts/mil)
- PTFE Heat Shrink tubing is available in stock packaging of 4-ft. straight lengths
- When ordering coiled tubing in colors, the color code is always followed by TC; when ordering cut lengths, the color code is followed by CC
i.e. HS2TFI7/8-2TC
i.e. HS2TFI7/8-0CC48.000

Order Information

Example: **HS4TFI5/8-NC48.000**

- HS4TFI5/8-NC48.000** – Heat Shrink
- HS4TFI5/8-NC48.000** – Shrink Ratio (4:1)
- HS4TFI5/8-NC48.000** – PTFE
- HS4TFI5/8-NC48.000** – Wall Type (Industrial Wall)
- HS4TFI5/8-NC48.000** – Heat Shrink Size in inches (5/8")
- HS4TFI5/8-NC48.000** – Natural
- HS4TFI5/8-NC48.000** – Bulk Tubing
- HS4TFI5/8-NC48.000** – Package Quantity in inches (48")

Colors

- Standard is natural
- Colors available as custom run

| Color Code | | | Color Code | | |
|----------------------------------|---|---------|----------------------------------|---|--------|
| <input type="radio"/> | N | Natural | <input checked="" type="radio"/> | 5 | Green |
| <input checked="" type="radio"/> | 0 | Black | <input checked="" type="radio"/> | 6 | Blue |
| <input checked="" type="radio"/> | 1 | Brown | <input checked="" type="radio"/> | 7 | Violet |
| <input checked="" type="radio"/> | 2 | Red | <input checked="" type="radio"/> | 8 | Gray |
| <input checked="" type="radio"/> | 3 | Orange | <input type="radio"/> | 9 | White |
| <input checked="" type="radio"/> | 4 | Yellow | | | |

Order Information

Example: **HS2TFS15-4TC48.000**

- HS2TFS15-4TC48.000** – Heat Shrink
- HS2TFS15-4TC48.000** – Shrink Ratio (2:1)
- HS2TFS15-4TC48.000** – PTFE
- HS2TFS15-4TC48.000** – Wall Type (Standard Wall)
- HS2TFS15-4TC48.000** – Heat Shrink Size in AWG (AWG15)
- HS2TFS15-4TC48.000** – Red
- HS2TFS15-4TC48.000** – Bulk Tubing
- HS2TFS15-4TC48.000** – Solid Color
- HS2TFS15-4TC48.000** – Package Quantity in inches (48")

WARNING

This product can expose you to chemicals including Tetrafluoroethylene, which is known to the State of California to cause cancer. For more information go to www.P65Warnings.ca.gov.

PTFE Heat Shrinkable Tubing

Series HS2TFS, HS2TFT, HS2TFL, HS2TFI, HS4TFI

Series HS2TFS, HS2TFT, HS2TFL, HS2TFI - 2:1 PTFE Fractional Heat Shrink Tubing

| Part Number | Mil Spec Part Number | Order Size | Minimum Expanded I.D. | | Maximum Recovered I.D. | | Nominal Recovered Wall | | Weight | |
|-------------|----------------------|------------|-----------------------|------|------------------------|------|------------------------|-------------|--------|--------|
| | | | inch | mm | inch | mm | inch | mm | lb/ft | kg/mtr |
| HS2TFS1/8 | - | 1/8 | 0.215 | 5.5 | 0.130 | 3.3 | 0.020 ± 0.004 | 0.51 ± 0.10 | 0.0085 | 0.0126 |
| HS2TFS1/4 | M23053/12-222-C | 1/4 | 0.410 | 10.4 | 0.260 | 4.9 | 0.020 ± 0.004 | 0.51 ± 0.10 | 0.0158 | 0.0235 |
| HS2TFS5/16 | M23053/12-225-C | 5/16 | 0.470 | 11.9 | 0.329 | 6.5 | 0.020 ± 0.004 | 0.51 ± 0.10 | 0.0190 | 0.0283 |
| HS2TFS3/8 | M23053/12-228-C | 3/8 | 0.560 | 14.2 | 0.399 | 8.1 | 0.025 ± 0.006 | 0.64 ± 0.15 | 0.0301 | 0.0448 |
| HS2TFS7/16 | M23053/12-229-C | 7/16 | 0.655 | 16.6 | 0.462 | 9.7 | 0.025 ± 0.006 | 0.64 ± 0.15 | 0.0332 | 0.0494 |
| HS2TFS1/2 | M23053/12-230-C | 1/2 | 0.750 | 19.1 | 0.524 | 11.4 | 0.025 ± 0.006 | 0.64 ± 0.15 | 0.0377 | 0.0561 |
| HS2TFS5/8 | M23053/12-231-C | 5/8 | 0.930 | 23.6 | 0.655 | 13.0 | 0.030 ± 0.006 | 0.76 ± 0.15 | 0.0605 | 0.0900 |
| HS2TFS3/4 | M23053/12-232-C | 3/4 | 1.125 | 28.6 | 0.786 | 14.5 | 0.035 ± 0.008 | 0.89 ± 0.20 | 0.0795 | 0.1183 |
| HS2TFS7/8 | M23053/12-233-C | 7/8 | 1.130 | 28.7 | 0.911 | 16.2 | 0.035 ± 0.008 | 0.89 ± 0.20 | 0.0921 | 0.1370 |
| HS2TFS1.00 | M23053/12-234-C | 1 | 1.500 | 38.1 | 1.034 | 26.3 | 0.035 ± 0.008 | 0.89 ± 0.20 | 0.1040 | 0.1548 |
| HS2TFT1/8 | M23053/12-319-C | 1/8 | 0.215 | 5.5 | 0.130 | 3.3 | 0.015 ± 0.003 | 0.38 ± 0.08 | 0.0061 | 0.0091 |
| HS2TFT1/4 | M23053/12-326-C | 1/4 | 0.410 | 10.4 | 0.260 | 6.6 | 0.015 ± 0.004 | 0.38 ± 0.10 | 0.0119 | 0.0177 |
| HS2TFT5/16 | M23053/12-329-C | 5/16 | 0.470 | 11.9 | 0.329 | 8.4 | 0.015 ± 0.004 | 0.38 ± 0.10 | 0.0148 | 0.0220 |
| HS2TFT3/8 | - | 3/8 | 0.560 | 14.2 | 0.399 | 10.1 | 0.015 ± 0.004 | 0.38 ± 0.10 | 0.0176 | 0.0262 |
| HS2TFT7/16 | - | 7/16 | 0.655 | 16.6 | 0.462 | 11.7 | 0.018 ± 0.004 | 0.46 ± 0.10 | 0.0240 | 0.0357 |
| HS2TFT1/2 | - | 1/2 | 0.750 | 19.1 | 0.524 | 13.3 | 0.018 ± 0.004 | 0.46 ± 0.10 | 0.0278 | 0.0414 |
| HS2TFT5/8 | - | 5/8 | 0.930 | 23.6 | 0.655 | 16.6 | 0.020 ± 0.004 | 0.51 ± 0.10 | 0.0375 | 0.0558 |
| HS2TFT3/4 | - | 3/4 | 1.125 | 28.6 | 0.786 | 20.0 | 0.025 ± 0.004 | 0.64 ± 0.10 | 0.0746 | 0.1110 |
| HS2TFT7/8 | - | 7/8 | 1.130 | 28.7 | 0.911 | 23.1 | 0.025 ± 0.004 | 0.64 ± 0.10 | 0.0795 | 0.1183 |
| HS2TFT1.00 | - | 1 | 1.500 | 38.1 | 1.034 | 26.3 | 0.025 ± 0.004 | 0.64 ± 0.10 | 0.0904 | 0.1345 |
| HS2TFL1/8 | M23053/12-415 | 1/8 | 0.215 | 5.5 | 0.130 | 3.3 | 0.008 ± 0.002 | 0.20 ± 0.05 | 0.0032 | 0.0048 |
| HS2TFL1/4 | M23053/12-422 | 1/4 | 0.410 | 10.4 | 0.260 | 6.6 | 0.010 ± 0.003 | 0.25 ± 0.08 | 0.0079 | 0.0118 |
| HS2TFL5/16 | M23053/12-425 | 5/16 | 0.470 | 11.9 | 0.329 | 8.4 | 0.012 ± 0.003 | 0.31 ± 0.08 | 0.0120 | 0.0179 |
| HS2TFI1/8 | - | 1/8 | 0.166 | 4.2 | 0.130 | 3.3 | 0.030 ± 0.005 | 0.76 ± 0.13 | 0.0114 | 0.0170 |
| HS2TFI3/16 | M23053/12-102-C | 3/16 | 0.250 | 6.4 | 0.193 | 4.9 | 0.030 ± 0.005 | 0.76 ± 0.13 | 0.0191 | 0.0284 |
| HS2TFI1/4 | M23053/12-103-C | 1/4 | 0.333 | 8.4 | 0.257 | 6.5 | 0.030 ± 0.005 | 0.76 ± 0.13 | 0.0246 | 0.0366 |
| HS2TFI5/16 | M23053/12-104-C | 5/16 | 0.415 | 10.5 | 0.320 | 8.1 | 0.030 ± 0.005 | 0.76 ± 0.13 | 0.0307 | 0.0457 |
| HS2TFI3/8 | M23053/12-105-C | 3/8 | 0.498 | 12.6 | 0.383 | 9.7 | 0.030 ± 0.005 | 0.76 ± 0.13 | 0.0342 | 0.0509 |
| HS2TFI7/16 | M23053/12-106-C | 7/16 | 0.580 | 14.7 | 0.448 | 11.4 | 0.030 ± 0.006 | 0.76 ± 0.15 | 0.0411 | 0.0612 |
| HS2TFI1/2 | M23053/12-107-C | 1/2 | 0.666 | 16.9 | 0.510 | 13.0 | 0.030 ± 0.006 | 0.76 ± 0.15 | 0.0461 | 0.0686 |
| HS2TFI9/16 | M23053/12-108-C | 1/2 | 0.748 | 19.0 | 0.572 | 14.5 | 0.030 ± 0.006 | 0.76 ± 0.15 | 0.0519 | 0.0772 |
| HS2TFI5/8 | M23053/12-109-C | 5/8 | 0.830 | 21.1 | 0.637 | 16.2 | 0.030 ± 0.006 | 0.76 ± 0.15 | 0.0476 | 0.0708 |
| HS2TFI11/16 | M23053/12-110-C | 11/16 | 0.915 | 23.2 | 0.700 | 17.8 | 0.032 ± 0.006 | 0.81 ± 0.15 | 0.6300 | 0.9374 |
| HS2TFI3/4 | - | 3/4 | 1.000 | 25.4 | 0.764 | 19.4 | 0.040 ± 0.007 | 1.02 ± 0.18 | 0.0941 | 0.1400 |
| HS2TFI7/8 | - | 7/8 | 1.170 | 29.7 | 0.891 | 22.6 | 0.045 ± 0.007 | 1.14 ± 0.18 | 0.1233 | 0.1835 |
| HS2TFI1.00 | - | 1 | 1.330 | 33.8 | 1.020 | 25.9 | 0.050 ± 0.008 | 1.27 ± 0.20 | 0.1566 | 0.2330 |

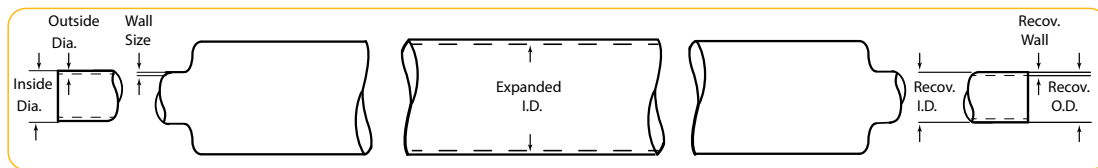

WARNING

This product can expose you to chemicals including Tetrafluoroethylene, which is known to the State of California to cause cancer. For more information go to www.P65Warnings.ca.gov.

PTFE Heat Shrinkable Tubing

Series HS2TFS AWG 2:1

Series HS2TFS - AWG 2:1 Standard Wall Heat Shrink Tubing

| Part Number | Mil Spec Part Number | Order Size AWG | Minimum Expanded I.D. | | Maximum Recovered I.D. | | Nominal Recovered Wall | | Weight | |
|-------------|----------------------|----------------|-----------------------|------|------------------------|-----|------------------------|-------------|--------|--------|
| | | | inch | mm | inch | mm | inch | mm | lb/ft | kg/mtr |
| HS2TFS24 | M23053/12-201-C | 24 | 0.050 | 1.3 | 0.027 | 0.7 | 0.012 ± 0.002 | 0.31 ± 0.05 | 0.0011 | 0.0016 |
| HS2TFS22 | M23053/12-202-C | 22 | 0.055 | 1.4 | 0.032 | 0.8 | 0.012 ± 0.002 | 0.31 ± 0.05 | 0.0013 | 0.0019 |
| HS2TFS20 | M23053/12-203-C | 20 | 0.060 | 1.5 | 0.039 | 1.0 | 0.016 ± 0.003 | 0.41 ± 0.08 | 0.0022 | 0.0033 |
| HS2TFS19 | M23053/12-204-C | 19 | 0.065 | 1.7 | 0.043 | 1.1 | 0.016 ± 0.003 | 0.41 ± 0.08 | 0.0024 | 0.0036 |
| HS2TFS18 | M23053/12-205-C | 18 | 0.076 | 1.9 | 0.049 | 1.3 | 0.016 ± 0.003 | 0.41 ± 0.08 | 0.0028 | 0.0042 |
| HS2TFS17 | M23053/12-206-C | 17 | 0.085 | 2.2 | 0.054 | 1.4 | 0.016 ± 0.003 | 0.41 ± 0.08 | 0.0029 | 0.0043 |
| HS2TFS16 | - | 16 | 0.093 | 2.4 | 0.061 | 1.6 | 0.016 ± 0.003 | 0.41 ± 0.08 | 0.0033 | 0.0049 |
| HS2TFS15 | M23053/12-207-C | 15 | 0.110 | 2.8 | 0.067 | 1.7 | 0.016 ± 0.003 | 0.41 ± 0.08 | 0.0035 | 0.0052 |
| HS2TFS14 | M23053/12-208-C | 14 | 0.120 | 3.1 | 0.072 | 1.8 | 0.016 ± 0.003 | 0.41 ± 0.08 | 0.0038 | 0.0057 |
| HS2TFS13 | M23053/12-210-C | 13 | 0.140 | 3.6 | 0.080 | 2.0 | 0.016 ± 0.003 | 0.41 ± 0.08 | 0.0041 | 0.0061 |
| HS2TFS12 | M23053/12-211-C | 12 | 0.150 | 3.8 | 0.089 | 2.3 | 0.016 ± 0.003 | 0.41 ± 0.08 | 0.0044 | 0.0065 |
| HS2TFS11 | M23053/12-212-C | 11 | 0.170 | 4.3 | 0.101 | 2.6 | 0.016 ± 0.003 | 0.41 ± 0.08 | 0.0050 | 0.0074 |
| HS2TFS10 | M23053/12-213-C | 10 | 0.191 | 4.9 | 0.112 | 2.8 | 0.016 ± 0.003 | 0.41 ± 0.08 | 0.0055 | 0.0082 |
| HS2TFS09 | M23053/12-214-C | 9 | 0.205 | 5.2 | 0.124 | 3.2 | 0.020 ± 0.004 | 0.51 ± 0.10 | 0.0075 | 0.0112 |
| HS2TFS08 | M23053/12-216-C | 8 | 0.240 | 6.1 | 0.141 | 3.6 | 0.020 ± 0.004 | 0.51 ± 0.10 | 0.0099 | 0.0147 |
| HS2TFS07 | M23053/12-217-C | 7 | 0.270 | 6.9 | 0.158 | 4.0 | 0.020 ± 0.004 | 0.51 ± 0.10 | 0.0097 | 0.0144 |
| HS2TFS06 | M23053/12-218-C | 6 | 0.302 | 7.7 | 0.178 | 4.5 | 0.020 ± 0.004 | 0.51 ± 0.10 | 0.0107 | 0.0159 |
| HS2TFS05 | M23053/12-219-C | 5 | 0.320 | 8.1 | 0.198 | 5.0 | 0.020 ± 0.004 | 0.51 ± 0.10 | 0.0133 | 0.0198 |
| HS2TFS04 | M23053/12-220-C | 4 | 0.370 | 9.4 | 0.224 | 5.7 | 0.020 ± 0.004 | 0.51 ± 0.10 | 0.0114 | 0.0170 |
| HS2TFS03 | M23053/12-221-C | 3 | 0.390 | 9.9 | 0.249 | 6.3 | 0.020 ± 0.004 | 0.51 ± 0.10 | 0.0150 | 0.0223 |
| HS2TFS02 | M23053/12-223-C | 2 | 0.430 | 10.9 | 0.278 | 7.1 | 0.020 ± 0.004 | 0.51 ± 0.10 | 0.0167 | 0.0248 |
| HS2TFS01 | M23053/12-224-C | 1 | 0.450 | 11.4 | 0.311 | 7.9 | 0.020 ± 0.004 | 0.51 ± 0.10 | 0.0186 | 0.0277 |
| HS2TFS00 | M23053/12-226-C | 0 | 0.470 | 11.9 | 0.347 | 8.8 | 0.020 ± 0.004 | 0.51 ± 0.10 | 0.0203 | 0.0302 |

*Dielectric Strength: > 800 v/m, per ASTM D 149 short term test of 10 MIL thickness (volts/mil)

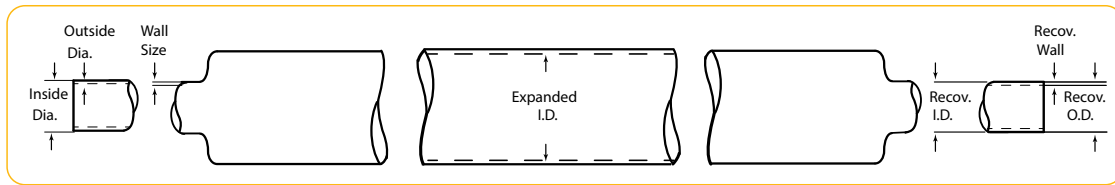

Colors

- ○ Standard is natural
- Colors available as custom run

| Color Code | | Color Code | |
|------------|-----------|------------|----------|
| ○ | N Natural | ● | 5 Green |
| ● | 0 Black | ● | 6 Blue |
| ● | 1 Brown | ● | 7 Violet |
| ● | 2 Red | ● | 8 Gray |
| ● | 3 Orange | ○ | 9 White |
| ● | 4 Yellow | | |

WARNING

This product can expose you to chemicals including Tetrafluoroethylene, which is known to the State of California to cause cancer. For more information go to www.P65Warnings.ca.gov.

PTFE Heat Shrinkable Tubing

Series HS2TFT AWG 2:1

Series HS2TFT - AWG 2:1 Thin Wall Heat Shrink Tubing

| Part Number | Mil Spec Part Number | Order Size AWG | Minimum Expanded I.D. | | Maximum Recovered I.D. | | Nominal Recovered Wall | | Weight | |
|-------------|----------------------|----------------|-----------------------|------|------------------------|-----|------------------------|-------------|--------|--------|
| | | | inch | mm | inch | mm | inch | mm | lb/ft | kg/mtr |
| HS2TFT24 | M23053/12-304-C | 24 | 0.050 | 1.3 | 0.027 | 0.7 | 0.010 ± 0.002 | 0.25 ± 0.08 | 0.0009 | 0.0013 |
| HS2TFT22 | M23053/12-305-C | 22 | 0.055 | 1.4 | 0.032 | 0.8 | 0.012 ± 0.003 | 0.31 ± 0.08 | 0.0014 | 0.0021 |
| HS2TFT20 | M23053/12-306-C | 20 | 0.060 | 1.5 | 0.039 | 1.0 | 0.012 ± 0.003 | 0.31 ± 0.08 | 0.0015 | 0.0022 |
| HS2TFT19 | M23053/12-307-C | 19 | 0.065 | 1.7 | 0.043 | 1.1 | 0.012 ± 0.003 | 0.31 ± 0.08 | 0.0018 | 0.0027 |
| HS2TFT18 | M23053/12-308-C | 18 | 0.076 | 1.9 | 0.049 | 1.3 | 0.012 ± 0.003 | 0.31 ± 0.08 | 0.0019 | 0.0028 |
| HS2TFT17 | M23053/12-309-C | 17 | 0.085 | 2.2 | 0.054 | 1.4 | 0.012 ± 0.003 | 0.31 ± 0.08 | 0.0021 | 0.0031 |
| HS2TFT16 | M23053/12-310-C | 16 | 0.093 | 2.4 | 0.061 | 1.6 | 0.012 ± 0.003 | 0.31 ± 0.08 | 0.0024 | 0.0036 |
| HS2TFT15 | M23053/12-311-C | 15 | 0.110 | 2.8 | 0.067 | 1.7 | 0.012 ± 0.003 | 0.31 ± 0.08 | 0.0025 | 0.0037 |
| HS2TFT14 | M23053/12-312-C | 14 | 0.120 | 3.1 | 0.072 | 1.8 | 0.012 ± 0.003 | 0.31 ± 0.08 | 0.0028 | 0.0042 |
| HS2TFT13 | M23053/12-313-C | 13 | 0.140 | 3.6 | 0.080 | 2.0 | 0.012 ± 0.003 | 0.31 ± 0.08 | 0.0030 | 0.0045 |
| HS2TFT12 | M23053/12-314-C | 12 | 0.150 | 3.8 | 0.089 | 2.3 | 0.012 ± 0.003 | 0.31 ± 0.08 | 0.0032 | 0.0048 |
| HS2TFT11 | M23053/12-316-C | 11 | 0.170 | 4.3 | 0.101 | 2.6 | 0.012 ± 0.003 | 0.31 ± 0.08 | 0.0036 | 0.0054 |
| HS2TFT10 | M23053/12-317-C | 10 | 0.191 | 4.9 | 0.112 | 2.8 | 0.012 ± 0.003 | 0.31 ± 0.08 | 0.0040 | 0.0060 |
| HS2TFT09 | M23053/12-318-C | 9 | 0.205 | 5.2 | 0.124 | 3.2 | 0.015 ± 0.004 | 0.38 ± 0.10 | 0.0056 | 0.0083 |
| HS2TFT08 | M23053/12-320-C | 8 | 0.240 | 6.1 | 0.141 | 3.6 | 0.015 ± 0.004 | 0.38 ± 0.10 | 0.0063 | 0.0094 |
| HS2TFT07 | M23053/12-321-C | 7 | 0.270 | 6.9 | 0.158 | 4.0 | 0.015 ± 0.004 | 0.38 ± 0.10 | 0.0071 | 0.0106 |
| HS2TFT06 | M23053/12-322-C | 6 | 0.302 | 7.7 | 0.178 | 4.5 | 0.015 ± 0.004 | 0.38 ± 0.10 | 0.0080 | 0.0119 |
| HS2TFT05 | M23053/12-323-C | 5 | 0.320 | 8.1 | 0.198 | 5.0 | 0.015 ± 0.004 | 0.38 ± 0.10 | 0.0090 | 0.0134 |
| HS2TFT04 | M23053/12-324-C | 4 | 0.370 | 9.4 | 0.224 | 5.7 | 0.015 ± 0.004 | 0.38 ± 0.10 | 0.0097 | 0.0144 |
| HS2TFT03 | M23053/12-325-C | 3 | 0.390 | 9.9 | 0.249 | 6.3 | 0.015 ± 0.004 | 0.38 ± 0.10 | 0.0108 | 0.0161 |
| HS2TFT02 | M23053/12-327-C | 2 | 0.430 | 10.9 | 0.278 | 7.1 | 0.015 ± 0.004 | 0.38 ± 0.10 | 0.0125 | 0.0186 |
| HS2TFT01 | M23053/12-328-C | 1 | 0.450 | 11.4 | 0.311 | 7.9 | 0.015 ± 0.004 | 0.38 ± 0.10 | 0.0123 | 0.0183 |
| HS2TFT00 | M23053/12-330-C | 0 | 0.470 | 11.9 | 0.347 | 8.8 | 0.015 ± 0.004 | 0.38 ± 0.10 | 0.0148 | 0.0220 |

*Dielectric Strength: > 800 v/m, per ASTM D 149 short term test of 10 MIL thickness (volts/mil)

Colors

- Standard is natural
- Colors available as custom run

| Color Code | | | Color Code | | |
|------------|---|---------|------------|---|--------|
| ○ | N | Natural | ● | 5 | Green |
| ● | 0 | Black | ● | 6 | Blue |
| ● | 1 | Brown | ● | 7 | Violet |
| ● | 2 | Red | ● | 8 | Gray |
| ● | 3 | Orange | ○ | 9 | White |
| ● | 4 | Yellow | | | |

WARNING

This product can expose you to chemicals including Tetrafluoroethylene, which is known to the State of California to cause cancer. For more information go to www.P65Warnings.ca.gov.

PTFE Heat Shrinkable Tubing

Series HS2TFL AWG 2:1

Series HS2TFL - AWG 2:1 Light Wall Heat Shrink Tubing

| Part Number | Mil Spec Part Number | Order Size AWG | Minimum Expanded I.D. | | Maximum Recovered I.D. | | Nominal Recovered Wall | | Weight | |
|-------------|----------------------|----------------|-----------------------|------|------------------------|-----|------------------------|-------------|--------|--------|
| | | | inch | mm | inch | mm | inch | mm | lb/ft | kg/mtr |
| HS2TFL24 | - | 24 | 0.050 | 1.3 | 0.025 | 0.6 | 0.006 ± 0.002 | 0.15 ± 0.05 | 0.0005 | 0.0007 |
| HS2TFL22 | - | 22 | 0.055 | 1.4 | 0.031 | 0.8 | 0.006 ± 0.002 | 0.15 ± 0.05 | 0.0006 | 0.0009 |
| HS2TFL20 | - | 20 | 0.060 | 1.5 | 0.038 | 1.0 | 0.006 ± 0.002 | 0.15 ± 0.05 | 0.0006 | 0.0009 |
| HS2TFL19 | - | 19 | 0.065 | 1.7 | 0.043 | 1.1 | 0.006 ± 0.002 | 0.15 ± 0.05 | 0.0007 | 0.0010 |
| HS2TFL18 | - | 18 | 0.076 | 1.9 | 0.046 | 1.2 | 0.006 ± 0.002 | 0.15 ± 0.05 | 0.0008 | 0.0012 |
| HS2TFL17 | - | 17 | 0.085 | 2.2 | 0.054 | 1.4 | 0.006 ± 0.002 | 0.15 ± 0.05 | 0.0009 | 0.0013 |
| HS2TFL16 | - | 16 | 0.093 | 2.4 | 0.057 | 1.5 | 0.006 ± 0.002 | 0.15 ± 0.05 | 0.0011 | 0.0016 |
| HS2TFL15 | - | 15 | 0.110 | 2.8 | 0.063 | 1.6 | 0.006 ± 0.002 | 0.15 ± 0.05 | 0.0011 | 0.0016 |
| HS2TFL14 | - | 14 | 0.120 | 3.1 | 0.072 | 1.8 | 0.008 ± 0.002 | 0.20 ± 0.05 | 0.0017 | 0.0025 |
| HS2TFL13 | - | 13 | 0.140 | 3.6 | 0.080 | 2.0 | 0.008 ± 0.002 | 0.20 ± 0.05 | 0.0018 | 0.0027 |
| HS2TFL12 | - | 12 | 0.150 | 3.8 | 0.089 | 2.3 | 0.008 ± 0.002 | 0.20 ± 0.05 | 0.0020 | 0.0030 |
| HS2TFL11 | - | 11 | 0.170 | 4.3 | 0.099 | 2.5 | 0.008 ± 0.002 | 0.20 ± 0.05 | 0.0023 | 0.0034 |
| HS2TFL10 | M23053/12-413 | 10 | 0.191 | 4.9 | 0.110 | 2.8 | 0.008 ± 0.002 | 0.20 ± 0.05 | 0.0026 | 0.0039 |
| HS2TFL09 | M23053/12-414 | 9 | 0.205 | 5.2 | 0.122 | 3.1 | 0.008 ± 0.002 | 0.20 ± 0.05 | 0.0026 | 0.0039 |
| HS2TFL08 | M23053/12-416 | 8 | 0.240 | 6.1 | 0.139 | 3.5 | 0.008 ± 0.002 | 0.20 ± 0.05 | 0.0032 | 0.0048 |
| HS2TFL07 | M23053/12-417 | 7 | 0.270 | 6.9 | 0.154 | 3.9 | 0.008 ± 0.002 | 0.20 ± 0.05 | 0.0037 | 0.0055 |
| HS2TFL06 | M23053/12-418 | 6 | 0.302 | 7.7 | 0.172 | 4.4 | 0.010 ± 0.003 | 0.25 ± 0.08 | 0.0049 | 0.0073 |
| HS2TFL05 | M23053/12-419 | 5 | 0.320 | 8.1 | 0.192 | 4.9 | 0.010 ± 0.003 | 0.25 ± 0.08 | 0.0057 | 0.0085 |
| HS2TFL04 | M23053/12-420 | 4 | 0.370 | 9.4 | 0.214 | 5.4 | 0.010 ± 0.003 | 0.25 ± 0.08 | 0.0063 | 0.0094 |
| HS2TFL03 | M23053/12-421 | 3 | 0.390 | 9.9 | 0.241 | 6.1 | 0.010 ± 0.003 | 0.25 ± 0.08 | 0.0068 | 0.0101 |
| HS2TFL02 | M23053/12-423 | 2 | 0.430 | 10.9 | 0.270 | 6.9 | 0.010 ± 0.003 | 0.25 ± 0.08 | 0.0077 | 0.0115 |
| HS2TFL01 | M23053/12-424 | 1 | 0.450 | 11.4 | 0.301 | 7.7 | 0.010 ± 0.003 | 0.25 ± 0.08 | 0.0085 | 0.0126 |
| HS2TFL00 | M23053/12-426 | 0 | 0.470 | 11.9 | 0.347 | 8.8 | 0.012 ± 0.003 | 0.31 ± 0.08 | 0.0118 | 0.0176 |

*Dielectric Strength: > 800 v/m, per ASTM D 149 short term test of 10 MIL thickness (volts/mil)

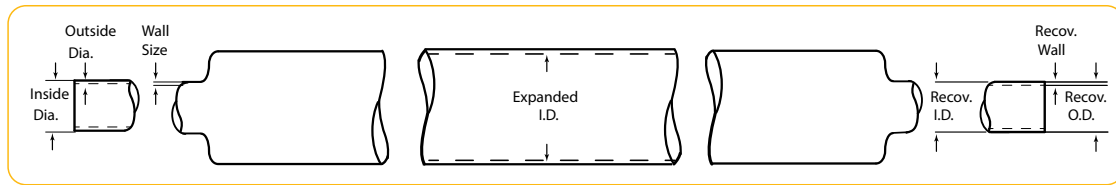

Colors

- ○ Standard is natural
- Colors available as custom run

| Color Code | | | Color Code | | |
|------------|---|---------|------------|---|--------|
| ○ | N | Natural | ● | 5 | Green |
| ● | 0 | Black | ● | 6 | Blue |
| ● | 1 | Brown | ● | 7 | Violet |
| ● | 2 | Red | ● | 8 | Gray |
| ● | 3 | Orange | ○ | 9 | White |
| ● | 4 | Yellow | | | |

WARNING

This product can expose you to chemicals including Tetrafluoroethylene, which is known to the State of California to cause cancer. For more information go to www.P65Warnings.ca.gov.

PTFE Heat Shrinkable Tubing

Series HS4TFI 4:1

Series HS4TFI - PTFE 4:1 Industrial Wall Heat Shrink Tubing

| Part Number | Mil Spec Part Number | Order Size | Minimum Expanded I.D. | | Maximum Recovered I.D. | | Nominal Recovered Wall | | Weight | |
|-------------|----------------------|------------|-----------------------|------|------------------------|-----|------------------------|-------------|--------|--------|
| | | | inch | mm | inch | mm | inch | mm | lb/ft | kg/mtr |
| HS4TFI5/64 | M23053/12-501 | 5/64 | 0.078 | 2.0 | 0.025 | 0.6 | 0.009 ± 0.002 | 0.23 ± 0.05 | 0.0008 | 0.0012 |
| HS4TFI1/8 | M23053/12-502 | 1/8 | 0.125 | 3.2 | 0.037 | 0.9 | 0.012 ± 0.002 | 0.31 ± 0.05 | 0.0014 | 0.0021 |
| HS4TFI3/16 | M23053/12-503 | 3/16 | 0.187 | 4.8 | 0.050 | 1.3 | 0.012 ± 0.002 | 0.31 ± 0.05 | 0.0020 | 0.0030 |
| HS4TFI1/4 | M23053/12-504 | 1/4 | 0.250 | 6.4 | 0.063 | 1.6 | 0.012 ± 0.002 | 0.31 ± 0.05 | 0.0028 | 0.0042 |
| HS4TFI5/16 | M23053/12-505 | 5/16 | 0.312 | 7.9 | 0.078 | 2.0 | 0.012 ± 0.002 | 0.31 ± 0.05 | 0.0030 | 0.0045 |
| HS4TFI3/8 | M23053/12-506 | 3/8 | 0.375 | 9.5 | 0.096 | 2.4 | 0.012 ± 0.002 | 0.31 ± 0.05 | 0.0035 | 0.0052 |
| HS4TFI7/16 | M23053/12-507 | 7/16 | 0.438 | 11.1 | 0.112 | 2.8 | 0.012 ± 0.002 | 0.31 ± 0.05 | 0.0048 | 0.0071 |
| HS4TFI1/2 | M23053/12-508 | 1/2 | 0.500 | 12.7 | 0.144 | 3.7 | 0.015 ± 0.004 | 0.38 ± 0.10 | 0.0075 | 0.0112 |
| HS4TFI5/8 | M23053/12-510 | 5/8 | 0.625 | 15.9 | 0.178 | 4.5 | 0.015 ± 0.004 | 0.38 ± 0.10 | 0.0092 | 0.0137 |
| HS4TFI3/4 | M23053/12-512 | 3/4 | 0.750 | 19.1 | 0.224 | 5.7 | 0.015 ± 0.004 | 0.38 ± 0.10 | 0.0113 | 0.0168 |
| HS4TFI7/8 | M23053/12-513 | 7/8 | 0.875 | 22.2 | 0.244 | 6.2 | 0.015 ± 0.004 | 0.38 ± 0.10 | 0.0116 | 0.0173 |
| HS4TFI1.00 | M23053/12-514 | 1 | 1.000 | 25.4 | 0.278 | 7.1 | 0.015 ± 0.004 | 0.38 ± 0.10 | 0.0140 | 0.0208 |
| HS4TFI1.25 | M23053/12-515 | 1-1/4 | 1.250 | 31.8 | 0.347 | 8.8 | 0.015 ± 0.004 | 0.38 ± 0.10 | 0.0174 | 0.0259 |

*Dielectric Strength: >800 v/m, per ASTM D 149 short term test of 10 MIL thickness (volts/mil)

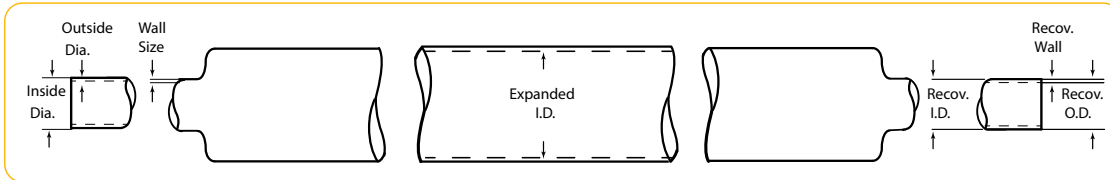

Colors

- ○ Standard is natural
- Colors available as custom run

| Color Code | | | Color Code | | |
|------------|---|---------|------------|---|--------|
| ○ | N | Natural | ● | 5 | Green |
| ● | 0 | Black | ● | 6 | Blue |
| ● | 1 | Brown | ● | 7 | Violet |
| ● | 2 | Red | ● | 8 | Gray |
| ● | 3 | Orange | ○ | 9 | White |
| ● | 4 | Yellow | | | |



WARNING

This product can expose you to chemicals including Tetrafluoroethylene, which is known to the State of California to cause cancer. For more information go to www.P65Warnings.ca.gov.

PTFE Convoluted Tubing

Series CV01, CVL, CVH

High temperature electrical insulation for harnessing wires and cables.



Features

- Chemically inert
- Low coefficient of friction
- Very flexible
- Self extinguishing
- Non-wetting
- Low Profile - Increased inside diameter
- Heavy Wall - Reinforces the strength of the tube allowing for braiding or covering, flanging or flaring; handles higher vacuum

Compliance

- 21 CFR 177.1550 compliant
- USP Class VI compliant

Notes

- Working Temperature: -100°F (-73°C) to 500°F (260°C)
- Standard cuffs are sized on the inside diameter
- ** Minimum 36" length

Colors

- ○ Standard is natural
- Colors available as custom run

| Color Code | | | Color Code | | |
|------------|---|---------|------------|---|--------|
| ○ | N | Natural | ● | 5 | Green |
| ● | 0 | Black | ● | 6 | Blue |
| ● | 1 | Brown | ● | 7 | Violet |
| ● | 2 | Red | ● | 8 | Gray |
| ● | 3 | Orange | ○ | 9 | White |
| ● | 4 | Yellow | | | |

Fittings

- Parker Fittings available from:
Fluid System Connectors Division
Otsego, MI
- (269) 692-6555
(269) 692-6634 FAX
parker.com/fsc
- For approved fittings and/or suggested use of tube supports, reference Tube/Fitting Compatibility Chart (pg. B-8/B-9) or contact Parker Fluid Systems Connectors Division

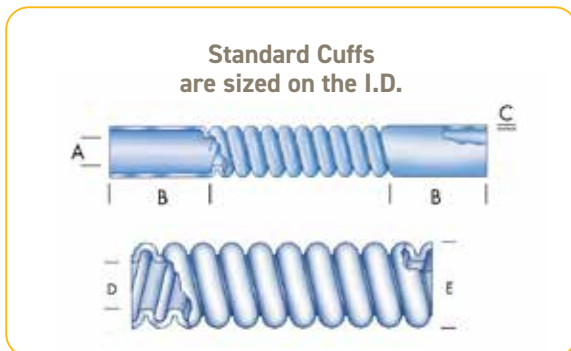

Order Information

Example: CV01-1/8-NT

CV01-1/8-NT – Convoluted

CV01-1/8-NT – PTFE

CV01-1/8-NT – Tube O.D. in inches (1/8")

CV01-1/8-NT – Natural

CV01-1/8-NT – Bulk Tubing "T" is bulk (for cuffed tubing, remove "T" and add length, ie. CV01-1/8-NT-N1200 = 1" Convo, natural, cut 12" long)

WARNING

This product can expose you to chemicals including Tetrafluoroethylene, which is known to the State of California to cause cancer. For more information go to www.P65Warnings.ca.gov.

PTFE Convoluted Tubing

Series CV01, CVL, CVH

Series CV01 - Standard Convoluted Tubing

| Part Number | Order Size | Standard Cuff I.D. "A" | | Standard Cuff Length "B" | | Wall Thickness "C" | | Minimum Inside Diameter "D" | | Maximum Inside Diameter "D" | | Maximum Outside Diameter "E" | | **Minimum Bend Radius | | Weight | |
|--------------|------------|------------------------|------|--------------------------|------|--------------------|------|-----------------------------|------|-----------------------------|------|------------------------------|------|-----------------------|-------|--------|--------|
| | | inch | mm | inch | mm | inch | mm | inch | mm | inch | mm | inch | mm | inch | mm | lb/ft | kg/mtr |
| CV01-1/8-NT | CONV-2 | 1/8 | 3.18 | 3/4 | 19.1 | 0.010 | 0.25 | 0.130 | 3.3 | 0.140 | 3.6 | 0.235 | 5.9 | 3/8 | 9.5 | 0.007 | 0.010 |
| CV01-1/4-NT | CONV-4 | 1/4 | 6.35 | 3/4 | 19.1 | 0.015 | 0.38 | 0.181 | 4.6 | 0.188 | 4.8 | 0.320 | 8.1 | 1/2 | 12.7 | 0.014 | 0.021 |
| CV01-5/16-NT | CONV-5 | 5/16 | 7.94 | 1 | 25.4 | 0.020 | 0.51 | 0.273 | 6.9 | 0.281 | 7.1 | 0.414 | 10.5 | 3/4 | 19.1 | 0.024 | 0.036 |
| CV01-3/8-NT | CONV-6 | 3/8 | 9.53 | 1 | 25.4 | 0.020 | 0.51 | 0.303 | 7.7 | 0.312 | 7.9 | 0.450 | 11.4 | 1-3/4 | 44.4 | 0.029 | 0.043 |
| CV01-1/2-NT | CONV-8 | 1/2 | 12.7 | 1 | 25.4 | 0.020 | 0.51 | 0.425 | 10.8 | 0.437 | 11.1 | 0.590 | 15.0 | 1-1/4 | 31.2 | 0.045 | 0.067 |
| CV01-5/8-NT | CONV-10 | 5/8 | 15.9 | 1-1/4 | 31.8 | 0.025 | 0.64 | 0.485 | 12.3 | 0.500 | 12.7 | 0.660 | 16.8 | 1-1/2 | 38.1 | 0.058 | 0.086 |
| CV01-3/4-NT | CONV-12 | 3/4 | 19.1 | 1-1/2 | 38.1 | 0.023 | 0.58 | 0.608 | 15.4 | 0.625 | 15.9 | 0.780 | 19.8 | 1-3/4 | 44.4 | 0.071 | 0.106 |
| CV01-1.00-NT | CONV-16 | 1 | 25.4 | 2 | 50.8 | 0.030 | 0.76 | 0.849 | 21.6 | 0.875 | 22.2 | 1.100 | 27.9 | 2-1/4 | 57.2 | 0.126 | 0.188 |
| CV01-1.25-NT | CONV-20 | 1-1/4 | 31.8 | 2-1/2 | 63.5 | 0.035 | 0.89 | 1.150 | 29.2 | 1.190 | 30.2 | 1.560 | 39.6 | 2-3/4 | 69.9 | 0.207 | 0.308 |
| CV01-1.50-NT | CONV-24 | 1-1/2 | 38.1 | 2-1/2 | 63.5 | 0.040 | 1.02 | 1.410 | 35.8 | 1.490 | 37.8 | 1.910 | 48.5 | 3 | 76.2 | 0.273 | 0.406 |
| CV01-2.00-NT | CONV-32 | 2 | 50.8 | 2-1/2 | 63.5 | 0.043 | 1.09 | 1.955 | 49.7 | 1.985 | 50.4 | 2.450 | 62.2 | 4-1/4 | 107.9 | 0.516 | 0.768 |
| CV01-2.50-NT | CONV-40 | 2-1/2 | 63.5 | 2-1/2 | 63.5 | 0.062 | 1.57 | 2.460 | 62.5 | 2.540 | 64.5 | 3.210 | 81.6 | 5 | 127.0 | 0.905 | 1.347 |
| CV01-3.00-NT | CONV-48 | 3 | 76.2 | 2-1/2 | 63.5 | 0.070 | 1.78 | 2.940 | 74.7 | 3.060 | 77.7 | 3.750 | 95.3 | 7 | 177.8 | 1.123 | 1.671 |

** Minimum 36" length

Series CVL - Low Profile Convoluted Tubing

| Part Number | Order Size | Minimum Inside Diameter | | Maximum Inside Diameter | | Maximum Outside Diameter | | Wall Thickness | | **Minimum Bend Radius | | Weight | |
|---------------|------------|-------------------------|------|-------------------------|------|--------------------------|------|----------------|------|-----------------------|-----|--------|--------|
| | | inch | mm | inch | mm | inch | mm | inch | mm | inch | mm | lb/ft | kg/mtr |
| CVL01-3/8-NT | 3/8 | 0.394 | 10.0 | 0.410 | 10.3 | 0.560 | 14.2 | 0.023 | 0.58 | 1/2 | 13 | 0.041 | 0.061 |
| CVL01-1/2-NT | 1/2 | 0.490 | 12.5 | 0.510 | 13.0 | 0.700 | 17.8 | 0.025 | 0.64 | 3/4 | 19 | 0.066 | 0.098 |
| CVL01-3/4-NT | 3/4 | 0.740 | 18.8 | 0.760 | 19.3 | 0.980 | 24.9 | 0.035 | 0.89 | 1.880 | 48 | 0.142 | 0.211 |
| CVL01-1.00-NT | 1 | 0.990 | 25.1 | 1.010 | 25.7 | 1.260 | 32.0 | 0.035 | 0.89 | 2-1/4 | 57 | 0.185 | 0.275 |
| CVL01-1.25-NT | 1-1/4 | 1.210 | 30.7 | 1.250 | 31.8 | 1.539 | 39.1 | 0.035 | 0.89 | 3 | 76 | 0.213 | 0.317 |
| CVL01-1.50-NT | 1-1/2 | 1.520 | 38.6 | 1.540 | 39.1 | 1.870 | 47.5 | 0.044 | 1.12 | 3-1/2 | 89 | 0.303 | 0.451 |
| CVL01-1.75-NT | 1-3/4 | 1.690 | 42.9 | 1.750 | 44.5 | 2.100 | 53.3 | 0.040 | 1.02 | 4-1/4 | 108 | *** | *** |
| CVL01-2.00-NT | 2 | 2.010 | 51.1 | 2.030 | 51.6 | 2.370 | 60.2 | 0.043 | 1.09 | 4-3/4 | 121 | 0.493 | 0.734 |

** Minimum 36" length ***Contact Division

Series CVH - Heavy Wall Convoluted Tubing

| Part Number | Order Size | Minimum Inside Diameter | | Maximum Inside Diameter | | Maximum Outside Diameter | | Wall Thickness | | **Minimum Bend Radius | | Weight | |
|---------------|------------|-------------------------|------|-------------------------|------|--------------------------|------|----------------|------|-----------------------|-----|--------|--------|
| | | inch | mm | inch | mm | inch | mm | inch | mm | inch | mm | lb/ft | kg/mtr |
| CVH01-1/4-NT | 1/4 | 0.257 | 6.5 | 0.265 | 6.7 | 0.415 | 10.5 | 0.025 | 0.64 | 3/4 | 19 | *** | *** |
| CVH01-3/8-NT | 3/8 | 0.335 | 8.5 | 0.345 | 8.8 | 0.510 | 13.0 | 0.025 | 0.64 | 1 | 25 | 0.039 | 0.058 |
| CVH01-1/2-NT | 1/2 | 0.454 | 11.5 | 0.466 | 11.8 | 0.700 | 17.8 | 0.035 | 0.89 | 1-1/2 | 38 | 0.053 | 0.079 |
| CVH01-3/4-NT | 3/4 | 0.683 | 17.4 | 0.701 | 17.8 | 1.010 | 25.7 | 0.050 | 1.27 | 1.880 | 48 | 0.083 | 0.124 |
| CVH01-1.00-NT | 1 | 0.841 | 21.4 | 0.859 | 21.8 | 1.210 | 30.7 | 0.053 | 1.35 | 2-1/2 | 64 | 0.265 | 0.394 |
| CVH01-1.25-NT | 1-1/4 | 1.125 | 28.6 | 1.145 | 29.1 | 1.610 | 40.9 | 0.062 | 1.57 | 3.130 | 79 | 0.381 | 0.567 |
| CVH01-1.50-NT | 1-1/2 | 1.420 | 36.1 | 1.480 | 37.6 | 1.880 | 47.8 | 0.062 | 1.57 | 3-3/5 | 95 | 0.454 | 0.676 |
| CVH01-1.75-NT | 1-3/4 | 1.540 | 39.1 | 1.600 | 40.6 | 2.100 | 53.3 | 0.062 | 1.57 | 4-1/4 | 114 | *** | *** |
| CVH01-2.00-NT | 2 | 1.770 | 45.0 | 1.830 | 46.5 | 2.432 | 61.8 | 0.062 | 1.57 | 4-3/4 | 120 | 0.729 | 1.085 |
| CVH01-2.50-NT | 2-1/2 | 2.460 | 62.5 | 2.540 | 64.5 | 3.210 | 81.5 | 0.062 | 1.57 | 5 | 127 | *** | *** |
| CVH01-3.00-NT | 3 | 2.940 | 74.7 | 3.060 | 77.7 | 3.750 | 95.3 | 0.062 | 1.57 | 7 | 178 | *** | *** |

** Minimum 36" length ***Contact Division

WARNING

This product can expose you to chemicals including Tetrafluoroethylene, which is known to the State of California to cause cancer. For more information go to www.P65Warnings.ca.gov.

PTFE Convoluted Tubing

Series 81914/1, 81914/2

Mil spec convoluted for the Military and Defense wire harnessing industries.



Features

- Chemically inert
- Low coefficient of friction
- Very flexible
- Self extinguishing
- Non-wetting

Compliance

- Dimensionally compliant to AS81914/1 and AS81914/2
- 21 CFR 177.1550 compliant

Notes

- Working Temperature: -100°F (-73°C) to 500°F (260°C)
- Tubing is provided in black without cuffs direct from inventory
- Stock packaging is random coils
- Also available in close convolution 81914/2

Colors

- ○ Standard is natural
- Colors available as custom run

| Color Code | | | Color Code | | |
|------------|---|---------|------------|---|--------|
| ○ | N | Natural | ● | 5 | Green |
| ● | 0 | Black | ● | 6 | Blue |
| ● | 1 | Brown | ● | 7 | Violet |
| ● | 2 | Red | ● | 8 | Gray |
| ● | 3 | Orange | ○ | 9 | White |
| ● | 4 | Yellow | | | |

Fittings

- Parker Fittings available from:
Fluid System Connectors Division
Otsego, MI
- (269) 692-6555
(269) 692-6634 FAX
parker.com/fsc
- For approved fittings and/or suggested use of tube supports, reference Tube/Fitting Compatibility Chart (pg. B-8/B-9) or contact Parker Fluid Systems Connectors Division

Order Information

Example: 81914/1-1010-OTC

81914/1-1010-OTC – Mil Spec Convoluted

81914/1-1010-OTC – PTFE

81914/1-1010-OTC – Helical Convolutions

81914/1-1010-OTC – Size 10 (1")

81914/1-1010-OTC – Color (Black)

81914/1-1010-OTC – Bulk Tubing ("T" is bulk)

WARNING

This product can expose you to chemicals including Tetrafluoroethylene, which is known to the State of California to cause cancer. For more information go to www.P65Warnings.ca.gov.

PTFE Convuluted Tubing

Series 81914/1, 81914/2

Series 81914/1 - Convuluted Tubing

| Part Number | Order Size | Maximum Inside Diameter | | Minimum Inside Diameter | | Maximum Outside Diameter | | Maximum Wall Thickness | | *Minimum Bend Radius | | Pitch | Weight | |
|------------------|------------|-------------------------|------|-------------------------|------|--------------------------|------|------------------------|-------|----------------------|-----|-------|--------|--------|
| | | inch | mm | inch | mm | inch | mm | inch | mm | inch | mm | | lb/ft | kg/mtr |
| 81914/1-1001-OTC | -1 | 0.188 | 4.78 | 0.181 | 4.6 | 0.320 | 8.13 | 0.023 | 0.584 | 1/2 | 13 | 8 | 0.020 | 0.030 |
| 81914/1-1002-OTC | -2 | 0.281 | 7.14 | 0.273 | 6.93 | 0.414 | 10.5 | 0.027 | 0.686 | 3/4 | 19 | 7.5 | 0.028 | 0.042 |
| 81914/1-1003-OTC | -3 | 0.312 | 7.93 | 0.303 | 7.7 | 0.450 | 11.4 | 0.027 | 0.686 | 7/8 | 22 | 7.5 | 0.029 | 0.043 |
| 81914/1-1004-OTC | -4 | 0.375 | 9.53 | 0.364 | 9.25 | 0.530 | 13.5 | 0.029 | 0.737 | 1 | 25 | 7 | 0.036 | 0.054 |
| 81914/1-1005-OTC | -5 | 0.437 | 11.1 | 0.425 | 10.8 | 0.590 | 15.0 | 0.029 | 0.737 | 1-1/4 | 32 | 7 | 0.049 | 0.073 |
| 81914/1-1006-OTC | -6 | 0.500 | 12.7 | 0.485 | 12.3 | 0.660 | 16.8 | 0.029 | 0.737 | 1-1/2 | 38 | 7 | 0.055 | 0.082 |
| 81914/1-1007-OTC | -7 | 0.625 | 15.9 | 0.608 | 15.4 | 0.780 | 19.9 | 0.035 | 0.889 | 1-3/4 | 44 | 7 | 0.062 | 0.092 |
| 81914/1-1008-OTC | -8 | 0.750 | 19.1 | 0.730 | 18.5 | 0.975 | 24.8 | 0.035 | 0.889 | 1.88 | 48 | 6 | 0.100 | 0.149 |
| 81914/1-1009-OTC | -9 | 0.875 | 22.2 | 0.850 | 21.6 | 1.100 | 27.9 | 0.035 | 0.889 | 2-1/4 | 57 | 6 | 0.120 | 0.179 |
| 81914/1-1010-OTC | -10 | 1.000 | 25.4 | 0.975 | 24.8 | 1.260 | 32.0 | 0.035 | 0.889 | 2-1/2 | 64 | 4.5 | 0.132 | 0.196 |
| 81914/1-1011-OTC | -11 | 1.125 | 28.6 | 1.100 | 27.9 | 1.390 | 35.3 | 0.035 | 0.889 | 2-3/4 | 70 | 4.5 | 0.170 | 0.253 |
| 81914/1-1012-OTC | -12 | 1.250 | 31.8 | 1.210 | 30.7 | 1.539 | 39.1 | 0.035 | 0.889 | 3 | 76 | 4 | 0.198 | 0.295 |
| 81914/1-1013-OTC | -13 | 1.500 | 38.1 | 1.440 | 36.6 | 1.850 | 47.0 | 0.040 | 1.020 | 3-3/4 | 95 | 4 | 0.245 | 0.365 |
| 81914/1-1014-OTC | -14 | 1.750 | 44.5 | 1.690 | 42.9 | 2.100 | 53.3 | 0.045 | 1.140 | 4-1/4 | 108 | 4 | 0.289 | 0.430 |
| 81914/1-1015-OTC | -15 | 2.000 | 50.8 | 1.940 | 49.3 | 2.350 | 59.7 | 0.045 | 1.140 | 4-3/4 | 121 | 4 | 0.371 | 0.552 |

*PTFE convuluted tubing is provided in BLACK without cuffs directly from the factory. Black part numbers are designated with "OT". Natural part numbers are designated with "NT" after the Mil Spec number (i.e., 81914/1-1014-OT). Also available in 81914/2 (Close Convolution).

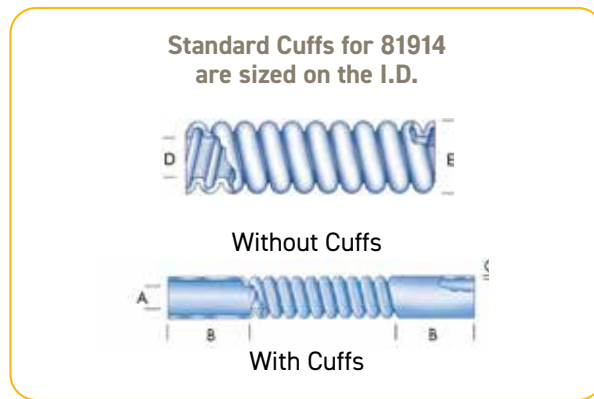

WARNING

This product can expose you to chemicals including Tetrafluoroethylene, which is known to the State of California to cause cancer. For more information go to www.P65Warnings.ca.gov.

FEP Tubing

Series 103, 203: Fractional & Metric

Translucent and chemically inert with long continuous lengths.

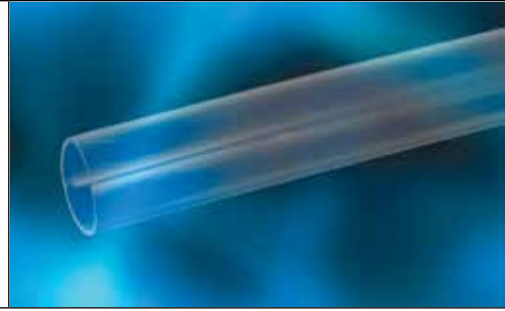

Features

- Virgin Fluorinated Ethylene Propylene resin
- Translucent
- Chemically inert
- Long continuous lengths
- Low coefficient of friction
- Self extinguishing
- Non-wetting
- Weldable

Compliance

- ASTM D2116
- 21 CFR 177.1550 compliant
- USP Class VI compliant

Notes

- Working Temperature: -100°F (-73°C) to 400°F (204°C)
- Vacuum Rating 28 @ 73°F
- Working pressure calculated using a Design Factor of 4
- Custom packaging and sizes are quoted upon request

Colors

- ○ Standard is natural
- Colors available as custom run

| Color Code | | | Color Code | | |
|------------|---|---------|------------|---|--------|
| ○ | N | Natural | ● | 5 | Green |
| ● | 0 | Black | ● | 6 | Blue |
| ● | 1 | Brown | ● | 7 | Violet |
| ● | 2 | Red | ● | 8 | Gray |
| ● | 3 | Orange | ○ | 9 | White |
| ● | 4 | Yellow | | | |

FEP Tubing (Series 103, 203) Maximum Working Pressure (psi)

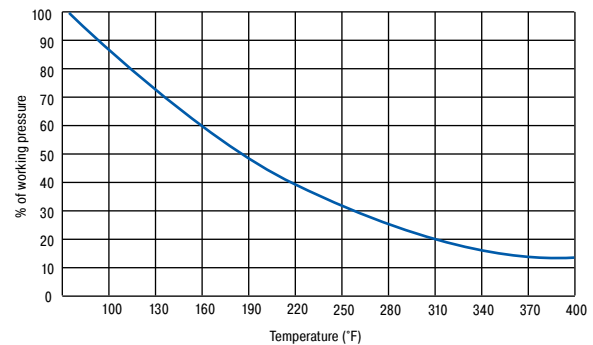

Fittings

- Parker Fittings available from:
Fluid System Connectors Division
Otsego, MI
(269) 692-6555
(269) 692-6634 FAX
parker.com/fsc
- For approved fittings and/or suggested use of tube supports, reference Tube/Fitting Compatibility Chart (pg. B-8/B-9) or contact Parker Fluid Systems Connectors Division

Order Information

Example: 103-0250031-NT-100

103-0250031-NT-100 – FEP

103-0250031-NT-100 – Tube O.D. in inches (1/4")

103-0250031-NT-100 – Tube Wall Thickness in inches (.031")

103-0250031-NT-100 – Natural

103-0250031-NT-100 – Bulk Tubing

103-0250031-NT-100 – Package Quantity in feet (100')

WARNING

This product can expose you to chemicals including Tetrafluoroethylene, which is known to the State of California to cause cancer. For more information go to www.P65Warnings.ca.gov.

FEP Tubing

Series 103

Series 103 - FEP Fractional Industrial Wall Tubing

| Part Number | Order Size | Nominal O.D. | | Nominal I.D. | | Reference Wall Thickness | | Working Pressure 73°F (23°C) | | Minimum Burst Pressure | | Minimum Bend Radius | | Vac. Rating | Weight | |
|-------------|------------|--------------|-------|--------------|-------|--------------------------|------|---------------------------------|-----|------------------------|-----|---------------------|-----|-------------|---------|--------|
| | | inch | mm | inch | mm | inch | mm | psi | bar | psi | bar | inch | mm | | lb./ft. | kg./mt |
| 103-0094031 | 3/32 | 0.094 | 2.40 | 0.031 | 0.79 | 0.031 | 0.79 | 630 | 43 | 1890 | 130 | 1/2 | 13 | 28 | 0.006 | 0.009 |
| 103-0125031 | 1/8 | 0.125 | 3.18 | 0.062 | 1.57 | 0.031 | 0.79 | 470 | 32 | 1410 | 97 | 3/8 | 10 | 28 | 0.009 | 0.013 |
| 103-0156031 | 5/32 | 0.157 | 3.99 | 0.094 | 2.39 | 0.031 | 0.79 | 360 | 25 | 1080 | 75 | 3/8 | 10 | 28 | 0.011 | 0.017 |
| 103-0188031 | 3/16 | 0.188 | 4.78 | 0.125 | 3.18 | 0.031 | 0.79 | 290 | 20 | 870 | 60 | 3/4 | 19 | 28 | 0.014 | 0.021 |
| 103-0250031 | 1/4 | 0.250 | 6.35 | 0.188 | 4.78 | 0.031 | 0.79 | 210 | 14 | 630 | 43 | 1-3/4 | 44 | 28 | 0.020 | 0.030 |
| 103-0312031 | 5/16 | 0.312 | 7.92 | 0.250 | 6.35 | 0.031 | 0.79 | 160 | 11 | 480 | 33 | 2-1/4 | 57 | 28 | 0.025 | 0.038 |
| 103-0375031 | 3/8 | 0.375 | 9.52 | 0.312 | 7.92 | 0.031 | 0.79 | 130 | 9 | 390 | 27 | 2-3/4 | 70 | 28 | 0.031 | 0.047 |
| 103-0438031 | 7/16 | 0.438 | 11.13 | 0.375 | 9.52 | 0.031 | 0.79 | 110 | 8 | 330 | 23 | 4 | 102 | 28 | 0.037 | 0.055 |
| 103-0500031 | 1/2 | 0.500 | 12.70 | 0.438 | 11.13 | 0.031 | 0.79 | 90 | 6 | 270 | 19 | 4 | 102 | 28 | 0.043 | 0.063 |
| 103-0563031 | 9/16 | 0.563 | 14.30 | 0.500 | 12.70 | 0.031 | 0.79 | 80 | 6 | 240 | 17 | 240 | 17 | 28 | 0.054 | 0.080 |

Series 103 - FEP Fractional Heavy Wall Tubing

| | | | | | | | | | | | | | | | | |
|-------------|------|-------|-------|-------|-------|-------|------|-----|----|------|-----|-------|-----|----|-------|-------|
| 103-0188062 | 3/16 | 0.188 | 4.78 | 0.064 | 1.63 | 0.062 | 1.57 | 630 | 43 | 1890 | 130 | 1/4 | 6 | 28 | 0.023 | 0.034 |
| 103-0250040 | 1/4 | 0.250 | 6.35 | 0.170 | 4.32 | 0.040 | 1.02 | 280 | 19 | 840 | 58 | 1-1/4 | 32 | 28 | 0.025 | 0.037 |
| 103-0250047 | 1/4 | 0.250 | 6.35 | 0.156 | 3.96 | 0.047 | 1.19 | 340 | 23 | 1020 | 70 | 3/4 | 19 | 28 | 0.028 | 0.042 |
| 103-0250062 | 1/4 | 0.250 | 6.35 | 0.125 | 3.18 | 0.062 | 1.57 | 470 | 32 | 1410 | 97 | 3/4 | 19 | 28 | 0.034 | 0.051 |
| 103-0312062 | 5/16 | 0.312 | 7.92 | 0.188 | 4.78 | 0.062 | 1.57 | 360 | 25 | 1080 | 74 | 1-3/8 | 35 | 28 | 0.045 | 0.067 |
| 103-0375062 | 3/8 | 0.375 | 9.52 | 0.250 | 6.35 | 0.062 | 1.57 | 290 | 20 | 870 | 60 | 1-1/2 | 38 | 28 | 0.057 | 0.085 |
| 103-0438062 | 7/16 | 0.438 | 11.13 | 0.312 | 7.92 | 0.062 | 1.57 | 250 | 17 | 750 | 52 | 2-5/8 | 67 | 28 | 0.068 | 0.101 |
| 103-0500062 | 1/2 | 0.500 | 12.70 | 0.375 | 9.53 | 0.062 | 1.57 | 210 | 14 | 630 | 43 | 2-1/8 | 54 | 28 | 0.079 | 0.118 |
| 103-0625062 | 5/8 | 0.625 | 15.88 | 0.500 | 12.70 | 0.062 | 1.57 | 160 | 11 | 480 | 33 | 3 | 76 | 28 | 0.102 | 0.152 |
| 103-0750062 | 3/4 | 0.750 | 19.05 | 0.625 | 15.88 | 0.062 | 1.57 | 130 | 9 | 390 | 27 | 6 | 152 | 28 | 0.125 | 0.186 |
| 103-1000062 | 1 | 1.000 | 25.40 | 0.875 | 22.22 | 0.062 | 1.57 | 90 | 6 | 270 | 19 | 8 | 203 | 28 | 0.170 | 0.253 |

Series 203 - FEP Metric Size Tubing

| Part Number | Order Size | Nominal O.D. | | Nominal I.D. | | Reference Wall Thickness | | Working Pressure 73°F (23°C) | | Minimum Burst Pressure | | Minimum Bend Radius | | Vac. Rating | Weight | |
|-------------|------------|--------------|-------|--------------|-------|--------------------------|-------|---------------------------------|-----|------------------------|------|---------------------|-------|-------------|---------|--------|
| | | mm | inch | mm | inch | mm | inch | bar | psi | bar | psi | inch | mm | | lb./ft. | kg./mt |
| 203-0300100 | 3 | 3 | 0.118 | 1 | 0.039 | 1 | 0.039 | 27 | 390 | 81 | 1170 | 6 | 1/4 | 28 | 0.014 | 0.009 |
| 203-0400100 | 4 | 4 | 0.157 | 2 | 0.079 | 1 | 0.039 | 20 | 290 | 60 | 870 | 13 | 1/2 | 28 | 0.020 | 0.014 |
| 203-0500100 | 5 | 5 | 0.197 | 3 | 0.118 | 1 | 0.039 | 15 | 220 | 45 | 660 | 19 | 3/4 | 28 | 0.027 | 0.018 |
| 203-0600100 | 6 | 6 | 0.236 | 4 | 0.157 | 1 | 0.039 | 12 | 180 | 36 | 540 | 29 | 1-1/8 | 28 | 0.034 | 0.023 |
| 203-0700100 | 7 | 7 | 0.276 | 5 | 0.197 | 1 | 0.039 | 10 | 150 | 30 | 450 | 44 | 1-3/4 | 28 | 0.041 | 0.027 |
| 203-0800100 | 8 | 8 | 0.315 | 6 | 0.236 | 1 | 0.039 | 9 | 130 | 27 | 390 | 51 | 2 | 28 | 0.047 | 0.032 |
| 203-0900100 | 9 | 9 | 0.354 | 7 | 0.275 | 1 | 0.039 | 8 | 110 | 24 | 330 | 54 | 2-1/8 | 28 | 0.054 | 0.036 |
| 203-1000100 | 10 | 10 | 0.393 | 8 | 0.315 | 1 | 0.039 | 7 | 100 | 21 | 300 | 70 | 2-3/4 | 28 | 0.061 | 0.041 |
| 203-1200100 | 12 | 12 | 0.472 | 10 | 0.394 | 1 | 0.039 | 6 | 80 | 18 | 240 | 76 | 3 | 28 | 0.074 | 0.050 |

WARNING

This product can expose you to chemicals including Tetrafluoroethylene, which is known to the State of California to cause cancer. For more information go to www.P65Warnings.ca.gov.

FEP Heat Shrinkable Tubing

Series HS1.3FEP, HS1.6FEP

Lower shrink temperature than PTFE.
Supplied in expanded state,
allowing for easy installation.

1.3/1 Heat Shrink Ratio
1.6/1 Heat Shrink Ratio



Features

- Easier to shrink than PTFE
- Chemically inert
- Low coefficient of friction
- Superior dielectric strength
- Good heat resistance
- Self extinguishing
- Non-wetting

Compliance

- ASTM D2902 Type II
- ASTM D3296
- Dimensionally compliant to AS23053/11
- 21 CFR 177.1550 compliant
- USP Class VI compliant

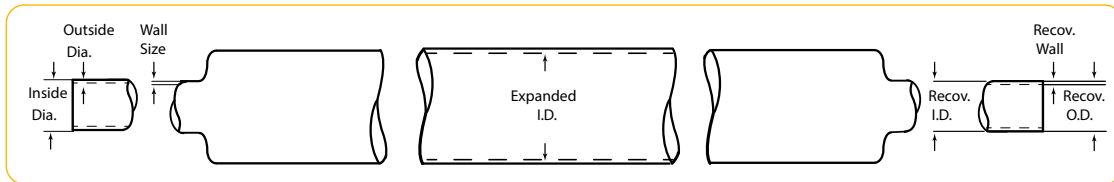

Notes

- Working Temperature: -100°F (-73°C) to 400°F (204°C)
- Shrink Temperature: 1" Dia. and below : 410°F (210°C) Over 1" Dia. : 430°F (221°C)
- *Dielectric Strength: > 2,000 v/m, per ASTM D 149 short term test of 10 MIL thickness (volts/mil)
- Available in stock packaging of 4-ft. straight lengths
- When ordering coiled tubing in colors, the color code is always followed by TC; when ordering cut lengths, the color code is followed by CC
i.e. HS1.3FEP24-2TC i.e. HS1.3FEP24-0CC48.000

Order Information

Example: **HS1.3FEP24-NT**

- HS1.3FEP24-NT** – Heat Shrink Tubing
- HS1.3FEP24-NT** – Shrink Ratio (1.3:1)
- HS1.3FEP24-NT** – FEP
- HS1.3FEP24-NT** – Heat Shrink Size in AWG (AWG24)
- HS1.3FEP24-NT** – Natural
- HS1.3FEP24-NT** – Bulk Tubing (Coil)

Colors

- ○ Standard is natural
- Colors available as custom run

| Color Code | | | Color Code | | |
|------------|---|---------|------------|---|--------|
| ○ | N | Natural | ● | 5 | Green |
| ● | 0 | Black | ● | 6 | Blue |
| ● | 1 | Brown | ● | 7 | Violet |
| ● | 2 | Red | ● | 8 | Gray |
| ● | 3 | Orange | ○ | 9 | White |
| ● | 4 | Yellow | | | |

Order Information

Example: **HS1.6FEP3/32-NC48.000**

- HS1.6FEP3/32-NC48.000** – Heat Shrink Tubing
- HS1.6FEP3/32-NC48.000** – Shrink Ratio (1.67:1)
- HS1.6FEP3/32-NC48.000** – FEP
- HS1.6FEP3/32-NC48.000** – Heat Shrink Size in inches (3/32")
- HS1.6FEP3/32-NC48.000** – Natural
- HS1.6FEP3/32-NC48.000** – Cut Tubing
- HS1.6FEP3/32-NC48.000** – Cut length in inches (48")

WARNING

This product can expose you to chemicals including Tetrafluoroethylene, which is known to the State of California to cause cancer. For more information go to www.P65Warnings.ca.gov.

FEP Heat Shrinkable Tubing

Series HS1.3FEP, HS1.6FEP

Series HS1.3FEP - 1.3:1 AWG & Fractional Heat Shrink Tubing

| Part Number | Mil Spec Part Number | Order Size | Minimum Expanded I.D. | | Maximum Recovered I.D. | | Nominal Recovered Wall | | Weight | |
|--------------|----------------------|------------|-----------------------|------|------------------------|------|------------------------|-------------|--------|--------|
| | | | inch | mm | inch | mm | inch | mm | lb/ft | kg/mtr |
| HS1.3FEP24 | M23053/11-101-* | AWG24 | 0.031 | 0.79 | 0.027 | 0.69 | 0.008 ± 0.002 | 0.20 ± 0.05 | 0.0008 | 0.0012 |
| HS1.3FEP22 | M23053/11-102-C | AWG22 | 0.036 | 0.91 | 0.032 | 0.81 | 0.008 ± 0.002 | 0.20 ± 0.05 | 0.0009 | 0.0013 |
| HS1.3FEP20 | M23053/11-103-C | AWG20 | 0.045 | 1.14 | 0.039 | 0.99 | 0.008 ± 0.002 | 0.20 ± 0.05 | 0.0011 | 0.0016 |
| HS1.3FEP18 | M23053/11-104-C | AWG18 | 0.060 | 1.52 | 0.049 | 1.25 | 0.008 ± 0.002 | 0.20 ± 0.05 | 0.0013 | 0.0019 |
| HS1.3FEP16 | M23053/11-105-C | AWG16 | 0.075 | 1.90 | 0.061 | 1.55 | 0.009 ± 0.002 | 0.23 ± 0.05 | 0.0018 | 0.0027 |
| HS1.3FEP14 | M23053/11-106-C | AWG14 | 0.092 | 2.34 | 0.072 | 1.83 | 0.009 ± 0.002 | 0.23 ± 0.05 | 0.0021 | 0.0031 |
| HS1.3FEP12 | M23053/11-107-C | AWG12 | 0.115 | 2.92 | 0.089 | 2.26 | 0.009 ± 0.002 | 0.23 ± 0.05 | 0.0026 | 0.0039 |
| HS1.3FEP10 | M23053/11-108-C | AWG10 | 0.141 | 3.58 | 0.114 | 2.90 | 0.010 ± 0.003 | 0.25 ± 0.08 | 0.0036 | 0.0054 |
| HS1.3FEP09 | M23053/11-109-C | AWG09 | 0.158 | 4.01 | 0.124 | 3.15 | 0.010 ± 0.003 | 0.25 ± 0.08 | 0.0039 | 0.0058 |
| HS1.3FEP08 | M23053/11-110-C | AWG08 | 0.180 | 4.57 | 0.143 | 3.63 | 0.010 ± 0.003 | 0.25 ± 0.08 | 0.0045 | 0.0067 |
| HS1.3FEP07 | M23053/11-111-C | AWG07 | 0.197 | 5.00 | 0.158 | 4.01 | 0.011 ± 0.004 | 0.28 ± 0.10 | 0.0054 | 0.0080 |
| HS1.3FEP06 | M23053/11-112-C | AWG06 | 0.225 | 5.72 | 0.180 | 4.57 | 0.011 ± 0.004 | 0.28 ± 0.10 | 0.0061 | 0.0091 |
| HS1.3FEP05 | M23053/11-113-C | AWG05 | 0.248 | 6.30 | 0.198 | 5.03 | 0.011 ± 0.004 | 0.28 ± 0.10 | 0.0067 | 0.0100 |
| HS1.3FEP04 | M23053/11-114-C | AWG04 | 0.290 | 7.37 | 0.226 | 5.74 | 0.011 ± 0.004 | 0.28 ± 0.10 | 0.0076 | 0.0113 |
| HS1.3FEP03 | M23053/11-115-C | AWG03 | 0.310 | 7.87 | 0.249 | 6.32 | 0.011 ± 0.003 | 0.28 ± 0.10 | 0.0084 | 0.0125 |
| HS1.3FEP02 | M23053/11-116-C | AWG02 | 0.365 | 9.27 | 0.280 | 7.11 | 0.012 ± 0.004 | 0.31 ± 0.10 | 0.0103 | 0.0153 |
| HS1.3FEP01 | M23053/11-117-C | AWG01 | 0.400 | 10.2 | 0.311 | 7.90 | 0.012 ± 0.004 | 0.31 ± 0.10 | 0.0113 | 0.0168 |
| HS1.3FEP00 | M23053/11-118-C | AWG00 | 0.440 | 11.2 | 0.349 | 8.86 | 0.012 ± 0.004 | 0.31 ± 0.10 | 0.0127 | 0.0189 |
| HS1.3FEP3/8 | M23053/11-119-C | 3/8 | 0.500 | 12.7 | 0.383 | 9.7 | 0.015 ± 0.004 | 0.38 ± 0.10 | 0.018 | 0.026 |
| HS1.3FEP7/16 | M23053/11-120-C | 7/16 | 0.580 | 14.7 | 0.448 | 11.4 | 0.020 ± 0.004 | 0.51 ± 0.10 | 0.030 | 0.044 |
| HS1.3FEP1/2 | M23053/11-121-C | 1/2 | 0.666 | 16.9 | 0.510 | 13.0 | 0.020 ± 0.004 | 0.51 ± 0.10 | 0.031 | 0.046 |
| HS1.3FEP5/8 | M23053/11-122-C | 5/8 | 0.830 | 21.1 | 0.637 | 16.2 | 0.025 ± 0.004 | 0.64 ± 0.10 | 0.048 | 0.072 |
| HS1.3FEP3/4 | M23053/11-123-C | 3/4 | 1.000 | 25.4 | 0.764 | 19.4 | 0.030 ± 0.004 | 0.76 ± 0.10 | 0.070 | 0.104 |
| HS1.3FEP7/8 | M23053/11-124-C | 7/8 | 1.170 | 29.7 | 0.891 | 22.6 | 0.035 ± 0.004 | 0.89 ± 0.10 | 0.095 | 0.141 |
| HS1.3FEP1.00 | M23053/11-126-C | 1 | 1.330 | 33.8 | 1.020 | 25.9 | 0.035 ± 0.004 | 0.89 ± 0.10 | 0.108 | 0.161 |
| HS1.3FEP1.13 | M23053/11-133-C | 1-1/8 | 1.500 | 38.1 | 1.145 | 29.1 | 0.035 ± 0.004 | 0.89 ± 0.10 | 0.121 | 0.180 |
| HS1.3FEP1.25 | M23053/11-134-C | 1-1/4 | 1.666 | 42.3 | 1.270 | 32.3 | 0.035 ± 0.004 | 0.89 ± 0.10 | 0.134 | 0.199 |
| HS1.3FEP1.38 | M23053/11-135-C | 1-3/8 | 1.833 | 46.6 | 1.390 | 35.3 | 0.035 ± 0.004 | 0.89 ± 0.10 | 0.146 | 0.217 |
| HS1.3FEP1.50 | M23053/11-136-C | 1-1/2 | 2.000 | 50.8 | 1.520 | 38.6 | 0.035 ± 0.004 | 0.89 ± 0.10 | 0.159 | 0.237 |

Series HS1.6FEP - 1.67:1 Heat Shrink Tubing

| Part Number | Mil Spec Part Number | Order Size | Minimum Expanded I.D. | | Maximum Recovered I.D. | | Nominal Recovered Wall | | Weight | |
|--------------|----------------------|------------|-----------------------|-------|------------------------|-------|------------------------|-------------|--------|--------|
| | | | inch | mm | inch | mm | inch | mm | lb/ft | kg/mtr |
| HS1.6FEP3/32 | M23053/11-201-C | 3/32 | 0.093 | 2.36 | 0.056 | 1.42 | 0.008 ± 0.003 | 0.20 ± 0.08 | 0.0015 | 0.0022 |
| HS1.6FEP1/8 | M23053/11-202-C | 1/8 | 0.125 | 3.18 | 0.075 | 1.90 | 0.010 ± 0.003 | 0.25 ± 0.08 | 0.0025 | 0.0037 |
| HS1.6FEP3/16 | M23053/11-203-C | 3/16 | 0.188 | 4.78 | 0.115 | 2.92 | 0.010 ± 0.003 | 0.25 ± 0.08 | 0.0037 | 0.0055 |
| HS1.6FEP1/4 | M23053/11-204-C | 1/4 | 0.250 | 6.35 | 0.150 | 3.81 | 0.010 ± 0.003 | 0.25 ± 0.08 | 0.0047 | 0.0070 |
| HS1.6FEP3/8 | M23053/11-205-C | 3/8 | 0.375 | 9.52 | 0.225 | 5.72 | 0.012 ± 0.003 | 0.31 ± 0.08 | 0.0083 | 0.0124 |
| HS1.6FEP1/2 | M23053/11-206-C | 1/2 | 0.500 | 12.70 | 0.300 | 7.62 | 0.015 ± 0.004 | 0.38 ± 0.10 | 0.0138 | 0.0205 |
| HS1.6FEP3/4 | M23053/11-207-C | 3/4 | 0.750 | 19.10 | 0.450 | 11.40 | 0.020 ± 0.004 | 0.51 ± 0.10 | 0.0275 | 0.0409 |
| HS1.6FEP1.00 | M23053/11-208-C | 1 | 1.000 | 25.40 | 0.600 | 15.20 | 0.025 ± 0.005 | 0.64 ± 0.13 | 0.0457 | 0.0680 |
| HS1.6FEP1.50 | M23053/11-209-C | 1-1/2 | 1.500 | 38.10 | 0.900 | 22.90 | 0.030 ± 0.005 | 0.76 ± 0.13 | 0.0817 | 0.1216 |
| HS1.6FEP2.00 | M23053/11-210-C | 2 | 2.000 | 50.80 | 1.200 | 30.50 | 0.030 ± 0.005 | 0.76 ± 0.13 | 0.1080 | 0.1607 |



WARNING

This product can expose you to chemicals including Tetrafluoroethylene, which is known to the State of California to cause cancer. For more information go to www.P65Warnings.ca.gov.

FEP Heat Shrinkable Tubing

Series HS1.25FEP, Roll Cover

Roll cover supplied expanded, allowing easy slippage over rollers.

1.25/1 Heat Shrink Ratio



Features

- Extends roller life
- Eliminates roller build up and picking
- Low coefficient of friction
- Flexible
- Good heat resistance

Compliance

- ASTM D2902 Type II
- Dimensionally compliant to AS23053/11

Notes

- Working Temperature: -100°F (-73°C) to 400°F (204°C)
- Shrink Temperature: 347°F (175°C) for 10 minutes - For high temperatures 500°F (260°C), PFA roll covers are available
- *Dielectric Strength: > 2,000 v/m, per ASTM D 149 short term test of 10 MIL thickness (volts/mil)
- Roll Cover is available in stock packaging of 4-ft. straight lengths
- For adhesion purposes, roll covers must be etched; Etching is available on the inside diameter, outside diameter or both

Colors

- Standard is natural
- Colors available as custom run

| Color Code | | | Color Code | | |
|----------------------------------|---|---------|----------------------------------|---|--------|
| <input type="radio"/> | N | Natural | <input checked="" type="radio"/> | 5 | Green |
| <input checked="" type="radio"/> | 0 | Black | <input checked="" type="radio"/> | 6 | Blue |
| <input checked="" type="radio"/> | 1 | Brown | <input checked="" type="radio"/> | 7 | Violet |
| <input checked="" type="radio"/> | 2 | Red | <input checked="" type="radio"/> | 8 | Gray |
| <input checked="" type="radio"/> | 3 | Orange | <input type="radio"/> | 9 | White |
| <input checked="" type="radio"/> | 4 | Yellow | | | |

Order Information

Example: HS1.25FEP3.50-NC48.000

HS1.25FEP3.50-NC48.000 – Heat Shrink Tubing

HS1.25FEP3.50-NC48.000 – Shrink Ratio (1.25:1)

HS1.25FEP3.50-NC48.000 – FEP

HS1.25FEP3.50-NC48.000 – Heat Shrink Expanded Size in inches (3-1/2")

HS1.25FEP3.50-NC48.000 – Natural

HS1.25FEP3.50-NC48.000 – Cut Tubing

HS1.25FEP3.50-NC48.000 – Cut length in inches (48")

WARNING

This product can expose you to chemicals including Tetrafluoroethylene, which is known to the State of California to cause cancer. For more information go to www.P65Warnings.ca.gov.

FEP Heat Shrinkable Tubing

Series HS1.25FEP, Roll Cover

Series HS1.25FEP - 1.25:1 FEP Heat Shrink Tubing

| Part Number | Mil Spec Part Number | Order Size | Minimum Expanded I.D. | | Maximum Recovered I.D. | | Nominal Recovered Wall | | Weight | |
|------------------|----------------------|------------|-----------------------|-------|------------------------|-------|------------------------|-------------|--------|--------|
| | | | inch | mm | inch | mm | inch | mm | lb/ft | kg/mtr |
| HS1.25FEP1.00-NT | - | 1 | 1.100 | 27.9 | 0.880 | 22.4 | 0.020 ± 0.004 | 0.508 +0.10 | 0.053 | 0.078 |
| HS1.25FEP1.25-NT | - | 1-1/4 | 1.300 | 33 | 1.000 | 25.4 | 0.020 ± 0.004 | 0.508 +0.10 | 0.060 | 0.089 |
| HS1.25FEP1.50-NT | M23053/11-127-C | 1-1/2 | 1.700 | 43.2 | 1.300 | 33 | 0.020 ± 0.004 | 0.508 +0.10 | 0.077 | 0.115 |
| HS1.25FEP2.00-NT | M23053/11-128-C | 2 | 2.100 | 53.3 | 1.700 | 43.2 | 0.020 ± 0.004 | 0.508 +0.10 | 0.101 | 0.150 |
| HS1.25FEP2.25-NT | - | 2-1/4 | 2.260 | 59.7 | 2.000 | 50.8 | 0.020 ± 0.004 | 0.508 +0.10 | 0.118 | 0.176 |
| HS1.25FEP2.50-NT | M23053/11-129-C | 2-1/2 | 2.600 | 66 | 2.100 | 53.3 | 0.020 ± 0.004 | 0.508 +0.10 | 0.124 | 0.185 |
| HS1.25FEP3.00-NT | M23053/11-130-C | 3 | 3.100 | 78.7 | 2.600 | 66 | 0.020 ± 0.004 | 0.508 +0.10 | 0.153 | 0.228 |
| HS1.25FEP3.50-NT | M23053/11-131-C | 3-1/2 | 3.500 | 88.9 | 3.100 | 78.7 | 0.020 ± 0.004 | 0.508 +0.10 | 0.183 | 0.272 |
| HS1.25FEP4.00-NT | M23053/11-132-C | 4 | 4.300 | 109.2 | 3.500 | 88.9 | 0.020 ± 0.004 | 0.508 +0.10 | 0.206 | 0.307 |
| HS1.25FEP5.00-NT | - | 5 | 5.200 | 132.1 | 4.300 | 109.3 | 0.020 ± 0.004 | 0.508 +0.10 | 0.253 | 0.376 |

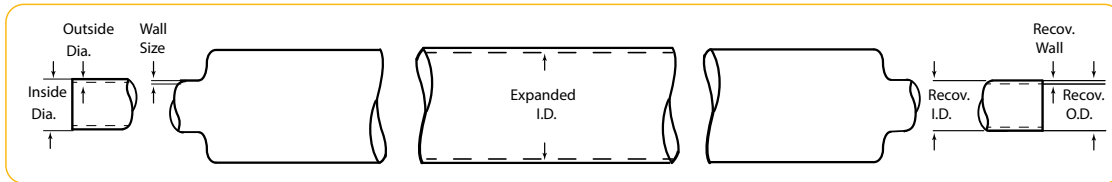

Colors

- Standard is natural
- Colors available as custom run

| Color Code | | | Color Code | | |
|------------|---|---------|------------|---|--------|
| ○ | N | Natural | ● | 5 | Green |
| ● | 0 | Black | ● | 6 | Blue |
| ● | 1 | Brown | ● | 7 | Violet |
| ● | 2 | Red | ● | 8 | Gray |
| ● | 3 | Orange | ○ | 9 | White |
| ● | 4 | Yellow | | | |



WARNING

This product can expose you to chemicals including Tetrafluoroethylene, which is known to the State of California to cause cancer. For more information go to www.P65Warnings.ca.gov.

FEP Convoluted Tubing

Series CV03, 81914/3

A Hose

B Tubing
Fluoropolymer

C Coiled Air Hose
& Fittings

D Transportation

E Fittings

F Tooling, Equipment,
& Accessories

G General Technical

High temperature electrical insulation
in long, continuous lengths.

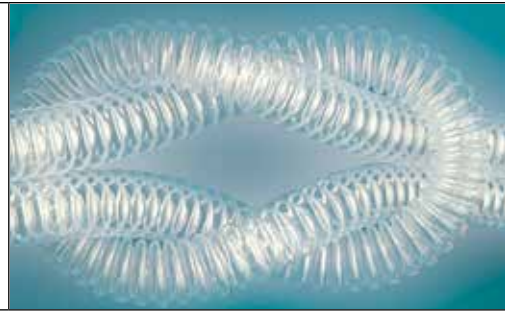

Features

- Cuffs are sized on the I.D.
- Very flexible
- Long continuous lengths
- Translucent
- Chemically inert
- Good flexlife

Notes

- Working Temperature: CV03 -100°F (-73°C) to 400°F (204°C)
81914 -100 °F (-73°C) to 392°F (200°C)
- Wire wrap reinforcement can be added for increased pressure applications or when a tighter bend radius is needed
- ** Minimum 36" length

Fittings

- Parker Fittings available from:
Fluid System Connectors Division
Otsego, MI
- (269) 692-6555
(269) 692-6634 FAX
parker.com/fsc
- For approved fittings and/or suggested use of tube supports, reference Tube/Fitting Compatibility Chart (pg. B-8/B-9) or contact Parker Fluid Systems Connectors Division

Compliance

- | | |
|-----------------------------|--|
| CV03 | 81914 |
| • ASTM D3296 | • Dimensionally compliant to AS81914/3 and AS81914/4 |
| • 21 CFR 177.1550 compliant | |
| • USP Class VI | |
| • | |

Order Information

Example: CV03-1/8-NT

CV03-1/8-NT – Convoluted

CV03-1/8-NT – FEP

CV03-1/8-NT – Size of Cuff I.D. (0.125")

CV03-1/8-NT – Natural

CV03-1/8-NT – Bulk Tubing "T" is bulk (for cuffed tubing, remove "T" and add length, ie. CV03-1/8-N1200 = 1/8" Convo FEP, natural, cut 12" long)

Standard Cuffs for FEP Convo
are sized on the I.D.

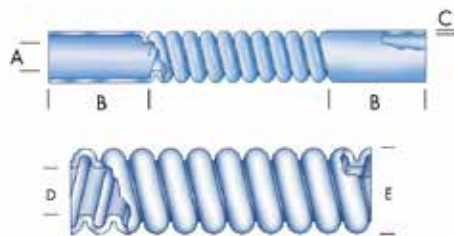

Order Information

Example: 81914/3-1001-NT

81914/3-1001-NT – Mil Spec Convoluted

81914/3-1001-NT – FEP

81914/3-1001-NT – Helical Convolutions

81914/3-1001-NT – Size 1 (0.187")

81914/3-1001-NT – Color (Natural)

81914/3-1001-NT – Bulk Tubing ("T" is bulk)

WARNING

This product can expose you to chemicals including Tetrafluoroethylene, which is known to the State of California to cause cancer. For more information go to www.P65Warnings.ca.gov.

FEP Convoluted Tubing

Series CV03, 81914/3

Series CV03 - FEP Convoluted Tubing

| Part Number | Order Size | Standard Cuff I.D. "A" | | Standard Cuff Length "B" | | Wall Thickness "C" | | Minimum Inside Diameter "D" | | Maximum Inside Diameter "D" | | Maximum Outside Diameter "E" | | **Minimum Bend Radius | | Weight | |
|--------------|------------|------------------------|-------|--------------------------|------|--------------------|-------|-----------------------------|-------|-----------------------------|-------|------------------------------|------|-----------------------|----|--------|--------|
| | | inch | mm | inch | mm | inch | mm | inch | mm | inch | mm | inch | mm | inch | mm | lb/ft | kg/mtr |
| CV03-1/4-NT | 1/4 | 1/4 | 6.35 | 3/4 | 19.1 | 0.020 | 0.508 | 0.251 | 6.38 | 0.265 | 6.73 | 0.405 | 10.3 | 0.365 | 9 | 0.320 | 8.1 |
| CV03-5/16-NT | 5/16 | 5/16 | 7.94 | 1 | 25.4 | 0.023 | 0.584 | 0.273 | 6.93 | 0.281 | 7.14 | 0.424 | 10.8 | 1/2 | 13 | 0.414 | 10.5 |
| CV03-3/8-NT | 3/8 | 3/8 | 9.53 | 1 | 25.4 | 0.023 | 0.584 | 0.364 | 9.25 | 0.375 | 9.53 | 0.530 | 13.5 | 7/8 | 22 | 0.450 | 11.4 |
| CV03-1/2-NT | 1/2 | 1/2 | 12.70 | 1 | 25.4 | 0.025 | 0.635 | 0.485 | 12.30 | 0.500 | 12.70 | 0.660 | 16.8 | 5/8 | 16 | 0.590 | 15.0 |
| CV03-5/8-NT | 5/8 | 5/8 | 15.90 | 1-1/4 | 31.8 | 0.025 | 0.635 | 0.609 | 15.50 | 0.625 | 15.90 | 0.780 | 19.8 | 1-1/2 | 38 | 0.660 | 16.8 |
| CV03-3/4-NT | 3/4 | 3/4 | 19.10 | 1-1/2 | 38.1 | 0.025 | 0.635 | 0.730 | 18.50 | 0.750 | 19.10 | 0.975 | 24.8 | 3-1/2 | 89 | 0.780 | 19.8 |
| CV03-1.00-NT | 1.00 | 1.000 | 25.40 | 2.000 | 50.8 | 0.030 | 0.762 | 0.975 | 24.80 | 1.000 | 25.40 | 1.260 | 32.0 | 2-1/4 | 57 | 1.100 | 27.9 |

Series 81914/3 Convoluted Tubing

| Part Number | Order Size | Maximum Inside Diameter | | Minimum Inside Diameter | | Maximum Outside Diameter | | Maximum Wall Thickness | | *Minimum Bend Radius | | Pitch | Weight | |
|-----------------|------------|-------------------------|-------|-------------------------|------|--------------------------|------|------------------------|-------|----------------------|----|-------|--------|--------|
| | | inch | mm | inch | mm | inch | mm | inch | mm | inch | mm | | lb/ft | kg/mtr |
| 81914/3-1001-NT | -1 | 0.187 | 4.75 | 0.181 | 4.60 | 0.320 | 8.13 | 0.018 | 0.457 | 1/2 | 13 | 8 | 0.017 | 0.025 |
| 81914/3-1002-NT | -2 | 0.281 | 7.14 | 0.273 | 6.93 | 0.414 | 10.5 | 0.018 | 0.457 | 3/4 | 19 | 8 | 0.028 | 0.042 |
| 81914/3-1003-NT | -3 | 0.312 | 7.93 | 0.306 | 7.77 | 0.450 | 11.4 | 0.018 | 0.457 | 3/4 | 19 | 8 | 0.030 | 0.045 |
| 81914/3-1004-NT | -4 | 0.375 | 9.53 | 0.364 | 9.25 | 0.510 | 13.0 | 0.018 | 0.457 | 7/8 | 22 | 8 | 0.036 | 0.053 |
| 81914/3-1005-NT | -5 | 0.437 | 11.10 | 0.427 | 10.9 | 0.571 | 14.5 | 0.018 | 0.457 | 7/8 | 22 | 8 | 0.050 | 0.074 |
| 81914/3-1006-NT | -6 | 0.500 | 12.70 | 0.485 | 12.3 | 0.650 | 16.5 | 0.023 | 0.584 | 1-1/4 | 32 | 7 | 0.048 | 0.071 |
| 81914/3-1007-NT | -7 | 0.625 | 15.90 | 0.608 | 15.4 | 0.770 | 19.6 | 0.023 | 0.584 | 1-1/2 | 38 | 7 | 0.062 | 0.092 |
| 81914/3-1008-NT | -8 | 0.750 | 19.10 | 0.730 | 18.5 | 0.930 | 23.6 | 0.023 | 0.584 | 1-3/4 | 44 | 6 | 0.093 | 0.138 |
| 81914/3-1009-NT | -9 | 0.875 | 22.20 | 0.860 | 21.8 | 1.073 | 27.3 | 0.023 | 0.584 | 2 | 51 | 5 | 0.086 | 0.128 |
| 81914/3-1010-NT | -10 | 1.000 | 25.40 | 0.975 | 24.8 | 1.226 | 31.1 | 0.023 | 0.584 | 2.370 | 60 | 5 | 0.107 | 0.159 |
| 81914/3-1011-NT | -11 | 1.125 | 28.60 | 1.105 | 28.1 | 1.390 | 35.3 | 0.023 | 0.584 | 2.370 | 60 | 5 | 0.146 | 0.217 |
| 81914/3-1012-NT | -12 | 1.250 | 31.80 | 1.210 | 30.7 | 1.539 | 39.1 | 0.023 | 0.584 | 2-3/4 | 70 | 4 | 0.185 | 0.275 |

FEP convoluted tubing is provided in NATURAL without cuffs directly from the factory. Natural part numbers are designated with "NT" after the Mil Spec number (i.e. 81914/3-1014) Also available in 81914/4 (Close Convolution).

Colors

- Standard is natural
- Colors available as custom run

| Color Code | | | Color Code | | |
|------------|---|---------|------------|---|--------|
| ○ | N | Natural | ● | 5 | Green |
| ● | 0 | Black | ● | 6 | Blue |
| ● | 1 | Brown | ● | 7 | Violet |
| ● | 2 | Red | ● | 8 | Gray |
| ● | 3 | Orange | ○ | 9 | White |
| ● | 4 | Yellow | | | |



WARNING

This product can expose you to chemicals including Tetrafluoroethylene, which is known to the State of California to cause cancer. For more information go to www.P65Warnings.ca.gov.

FEP Corrugated Tubing

Series CR03

Turn sharp corners without kinking or slowing flow.

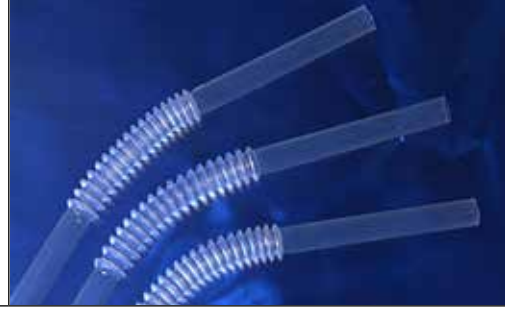

Features

- Capable of turning sharp corners without reducing the inside diameter of the tube
- Extremely flexible
- Kink resistant
- Non stick surface allows for easy cleaning
- Excellent clarity
- Chemically inert
- Available in FEP, PFA and High Purity PFA

Compliance

- FEP - ASTM D3296
- PFA - ASTM D3307
- 21 CFR 177.1550 compliant
- USP Class VI compliant

Colors

- ○ Natural, translucent

Notes

- Working Temperature: -100°F (-73°C) to 200°F (93°C)
For higher temperatures, request PFA Corrugated (CR04) -100°F (-73°C) to 300°F (148°C) @ 0 pressure
- Vacuum Service: 29.9 IN. Hg (759M Hg)
- Extension-Compression Length Ratio: Approximately 2:1
- Tubing is provided in natural in custom lengths with a maximum length of 12 feet/3 meters
- Corrugated tubing is also available in specialty configurations where corrugated and straight tubing run intermittently along the tube

Fittings

- Parker Fittings available from:
Fluid System Connectors Division
Otsego, MI
(269) 692-6555
(269) 692-6634 FAX
parker.com/fscc
- For approved fittings and/or suggested use of tube supports, reference Tube/Fitting Compatibility Chart (pg. B-8/B-9) or contact Parker Fluid Systems Connectors Division

Example: CR01-1.00-NC29.000-2C

CR03-1.00-NC29.000-2C – Corrugated Tubing
CR03-1.00-NC29.000-2C – FEP
CR03-1.00-NC29.000-2C – Tube Size Nominal I.D. (1")
CR03-1.00-NC29.000-2C – Natural
CR03-1.00-NC29.000-2C – Cut Piece
CR03-1.00-NC29.000-2C – Overall Length in inches (29")
CR03-1.00-NC29.000-2C – Standard Cuff on each end

WARNING

This product can expose you to chemicals including Tetrafluoroethylene, which is known to the State of California to cause cancer. For more information go to www.P65Warnings.ca.gov.

FEP Corrugated Tubing

Series CR03

Series CR03 - FEP Corrugated Tubing

| Part Number | Order Size | Maximum Cuff I.D. "A" | | Standard Cuff Length "B" | | Wall Thickness "C" | | Reference Outside Diameter "D" | | Corrugated Length "E" ±1 | **Minimum Bend Radius | | Weight | |
|--------------|------------|-----------------------|------|--------------------------|------|--------------------|------|--------------------------------|------|----------------------------------|-----------------------|------|--------|--------|
| | | inch | mm | inch | mm | inch | mm | inch | mm | | inch | mm | lb/ft | kg/mtr |
| CR03-1/4-NT | 1/4 | 0.250 | 6.35 | 3/4 | 19.1 | 0.015 | 0.38 | 0.375 | 9.53 | To be specified at time of order | 0.125 | 3.18 | * | * |
| CR03-3/8-NT | 3/8 | 0.375 | 9.53 | 1 | 25.4 | 0.020 | 0.51 | 0.625 | 15.9 | | 0.187 | 4.76 | * | * |
| CR03-1/2-NT | 1/2 | 0.500 | 12.7 | 1 | 25.4 | 0.025 | 0.64 | 0.750 | 19.0 | | 0.250 | 6.35 | * | * |
| CR03-5/8-NT | 5/8 | 0.625 | 15.9 | 1 | 25.4 | 0.025 | 0.64 | 0.938 | 23.8 | | 0.312 | 7.94 | * | * |
| CR03-3/4-NT | 3/4 | 0.750 | 19.1 | 1-1/2 | 38.1 | 0.030 | 0.76 | 1.063 | 26.9 | | 0.375 | 9.53 | * | * |
| CR03-7/8-NT | 7/8 | 0.875 | 22.2 | 1-1/2 | 38.1 | 0.030 | 0.76 | 1.250 | 31.8 | | 0.438 | 11.1 | * | * |
| CR03-1.00-NT | 1 | 1.000 | 24.8 | 2 | 50.8 | 0.035 | 0.89 | 1.438 | 36.5 | | 0.500 | 12.7 | * | * |
| CR03-1.25-NT | 1-1/4 | 1.250 | 31.8 | 2 | 50.8 | 0.035 | 0.89 | 1.625 | 41.3 | | 0.625 | 15.9 | * | * |
| CR03-1.50-NT | 1-1/2 | 1.500 | 38.1 | 2 | 50.8 | 0.035 | 0.89 | 1.813 | 46.1 | | 0.750 | 19.1 | * | * |
| CR03-2.00-NT | 2 | 2.000 | 50.8 | 2 | 50.8 | 0.040 | 1.02 | 2.625 | 66.7 | | 1.000 | 25.4 | * | * |
| CR03-2.50-NT | 2-1/2 | 2.500 | 63.8 | 2-1/2 | 63.5 | 0.070 | 1.78 | 3.360 | 85.3 | | 2.500 | 63.5 | * | * |

Note: * Contact the division

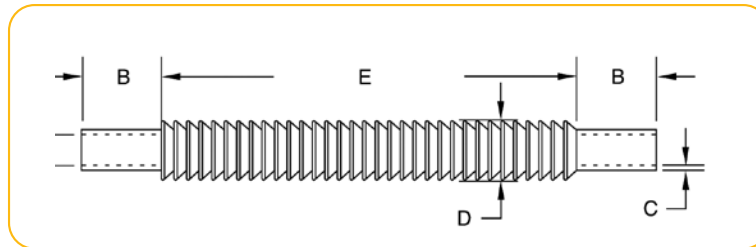

WARNING

This product can expose you to chemicals including Tetrafluoroethylene, which is known to the State of California to cause cancer. For more information go to www.P65Warnings.ca.gov.

PFA Tubing

Series 104, 204

A Hose

Tubing
Fluoropolymer

Coiled Air Hose
& Fittings

D Transportation

F Fittings

Tooling, Equipment,
& Accessories

General Technical

Combines the high temperature of PTFE with the long continuous lengths of FEP



Features

- Virgin Perfluoroalkoxy
- Translucent
- Low permeability
- Exceptional heat resistance
- Chemically inert
- Long continuous lengths
- Low coefficient of friction
- Self extinguishing
- Non-wetting
- Non leaching

High Purity (105, 205)

- Withstands corrosive surfactants for longer periods of time
- Highest molecular weight available

Compliance

- ASTM D3307
- 21 CFR 177.1550 compliant
- USP Class VI

Notes

- Working Temperature: -100°F (-73°C) to 500°F (260°C)
- Vacuum Rating 28 @ 73°F
- Working pressure calculated using a Design Factor of 4
- Custom packaging and sizes are quoted upon request

PFA Tubing (Series 104, 105, 204, 205) Maximum Working Pressure (psi)

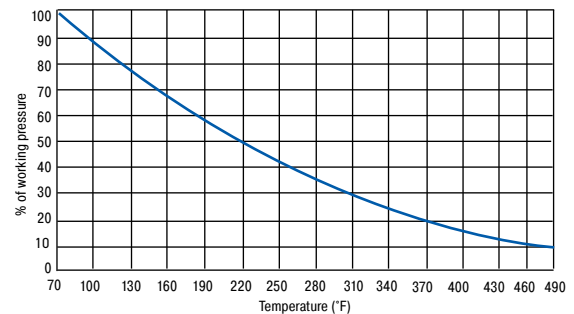

Fittings

- Parker Fittings available from:
Fluid System Connectors Division
Otsego, MI
- (269) 692-6555
(269) 692-6634 FAX
parker.com/fsc
- For approved fittings and/or suggested use of tube supports, reference Tube/Fitting Compatibility Chart (pg. B-8/B-9) or contact Parker Fluid Systems Connectors Division

Order Information

Example: 104-0188062-NT-100

104-0188062-NT-100 – PFA

104-0188062-NT-100 – Tube O.D. in inches (3/16")

104-0188062-NT-100 – Tube Wall Thickness in inches (.062")

104-0188062-NT-100 – Natural

104-0188062-NT-100 – Bulk Tubing

104-0188062-NT-100 – Package Quantity in feet (100')

WARNING

This product can expose you to chemicals including Tetrafluoroethylene, which is known to the State of California to cause cancer. For more information go to www.P65Warnings.ca.gov.

PFA Tubing

Series 104, 204

Series 104 - PFA Fractional Industrial Wall Tubing

| Part Number | Order Size | Nominal O.D. | | Nominal I.D. | | Reference Wall Thickness | | Working Pressure 73°F (23°C) | | Minimum Burst Pressure | | Minimum Bend Radius | | Vac. Rating | Weight | |
|-------------|------------|--------------|-------|--------------|-------|--------------------------|------|------------------------------|-----|------------------------|-----|---------------------|-----|-------------|---------|--------|
| | | inch | mm | inch | mm | inch | mm | psi | bar | psi | bar | inch | mm | | lb./ft. | kg./mt |
| 104-0094031 | 3/32 | 0.094 | 2.40 | 0.031 | 0.79 | 0.031 | 0.79 | 680 | 47 | 2040 | 141 | 1/4 | 6 | 28 | 0.006 | 0.009 |
| 104-0125031 | 1/8 | 0.125 | 3.18 | 0.064 | 1.63 | 0.031 | 0.79 | 500 | 34 | 1500 | 103 | 3/8 | 10 | 28 | 0.009 | 0.013 |
| 104-0156031 | 5/32 | 0.157 | 3.99 | 0.094 | 2.39 | 0.031 | 0.79 | 390 | 27 | 1170 | 81 | 5/8 | 16 | 28 | 0.011 | 0.016 |
| 104-0188031 | 3/16 | 0.188 | 4.78 | 0.125 | 3.18 | 0.031 | 0.79 | 320 | 22 | 960 | 66 | 5/8 | 16 | 28 | 0.014 | 0.021 |
| 104-0250031 | 1/4 | 0.250 | 6.35 | 0.188 | 4.78 | 0.031 | 0.79 | 230 | 16 | 690 | 48 | 7/8 | 22 | 28 | 0.020 | 0.030 |
| 104-0312031 | 5/16 | 0.312 | 7.92 | 0.250 | 6.35 | 0.031 | 0.79 | 180 | 12 | 540 | 37 | 1-3/4 | 44 | 28 | 0.025 | 0.037 |
| 104-0375031 | 3/8 | 0.375 | 9.52 | 0.312 | 7.92 | 0.031 | 0.79 | 140 | 10 | 420 | 29 | 3-1/4 | 83 | 28 | 0.031 | 0.046 |
| 104-0438031 | 7/16 | 0.438 | 11.13 | 0.375 | 9.53 | 0.031 | 0.79 | 120 | 8 | 360 | 25 | 3-1/4 | 83 | 28 | 0.037 | 0.055 |
| 104-0500031 | 1/2 | 0.500 | 12.70 | 0.438 | 11.13 | 0.031 | 0.79 | 100 | 7 | 300 | 21 | 4-3/4 | 121 | 28 | 0.043 | 0.064 |
| 104-0563031 | 9/16 | 0.563 | 14.30 | 0.500 | 12.70 | 0.031 | 0.79 | 80 | 6 | 240 | 17 | 5 | 127 | 28 | 0.054 | 0.080 |

Series 104 - PFA Fractional Heavy Wall Tubing

| | | | | | | | | | | | | | | | | |
|-------------|------|-------|-------|-------|-------|-------|------|-----|----|------|-----|-------|-----|----|-------|-------|
| 104-0188062 | 3/16 | 0.188 | 4.78 | 0.064 | 1.63 | 0.062 | 1.57 | 630 | 43 | 1890 | 130 | 1/4 | 6 | 28 | 0.023 | 0.034 |
| 104-0250040 | 1/4 | 0.250 | 6.35 | 0.170 | 4.32 | 0.040 | 1.02 | 280 | 19 | 840 | 58 | 1-1/4 | 32 | 28 | 0.025 | 0.037 |
| 104-0250047 | 1/4 | 0.250 | 6.35 | 0.156 | 3.96 | 0.047 | 1.19 | 340 | 23 | 1020 | 70 | 3/4 | 19 | 28 | 0.028 | 0.042 |
| 104-0250062 | 1/4 | 0.250 | 6.35 | 0.125 | 3.18 | 0.062 | 1.57 | 470 | 32 | 1410 | 97 | 3/4 | 19 | 28 | 0.034 | 0.051 |
| 104-0312062 | 5/16 | 0.312 | 7.92 | 0.188 | 4.78 | 0.062 | 1.57 | 360 | 25 | 1080 | 74 | 1-3/8 | 35 | 28 | 0.045 | 0.067 |
| 104-0375062 | 3/8 | 0.375 | 9.52 | 0.250 | 6.35 | 0.062 | 1.57 | 290 | 20 | 870 | 60 | 1-1/2 | 38 | 28 | 0.057 | 0.085 |
| 104-0438062 | 7/16 | 0.438 | 11.13 | 0.312 | 7.92 | 0.062 | 1.57 | 250 | 17 | 750 | 52 | 2-5/8 | 67 | 28 | 0.068 | 0.101 |
| 104-0500062 | 1/2 | 0.500 | 12.70 | 0.375 | 9.53 | 0.062 | 1.57 | 210 | 14 | 630 | 43 | 2-1/8 | 54 | 28 | 0.079 | 0.118 |
| 104-0625062 | 5/8 | 0.625 | 15.88 | 0.500 | 12.70 | 0.062 | 1.57 | 160 | 11 | 480 | 33 | 3 | 76 | 28 | 0.102 | 0.152 |
| 104-0750062 | 3/4 | 0.750 | 19.05 | 0.625 | 15.88 | 0.062 | 1.57 | 130 | 9 | 390 | 27 | 6 | 152 | 28 | 0.125 | 0.186 |
| 104-1000062 | 1 | 1.000 | 25.40 | 0.875 | 22.22 | 0.062 | 1.57 | 90 | 6 | 270 | 19 | 8 | 203 | 28 | 0.170 | 0.253 |

Series 204 - PFA Metric Size Tubing

| Part Number | Order Size | Nominal O.D. | | Nominal I.D. | | Reference Wall Thickness | | Working Pressure 73°F (23°C) | | Minimum Burst Pressure | | Minimum Bend Radius | | Vac. Rating | Weight | |
|-------------|------------|--------------|-------|--------------|-------|--------------------------|-------|------------------------------|-----|------------------------|-----|---------------------|-------|-------------|--------|-------|
| | | mm | inch | mm | inch | mm | inch | bar | psi | bar | psi | mm | inch | | kg/mtr | lb/ft |
| 204-0400100 | 4 | 4 | 0.157 | 2 | 0.079 | 1 | 0.039 | 20 | 290 | 60 | 870 | 13 | 1/2 | 28 | 0.020 | 0.014 |
| 204-0600100 | 6 | 6 | 0.236 | 4 | 0.157 | 1 | 0.039 | 12 | 180 | 36 | 540 | 29 | 1-1/8 | 28 | 0.034 | 0.023 |
| 204-0800100 | 8 | 8 | 0.315 | 6 | 0.236 | 1 | 0.039 | 9 | 130 | 27 | 390 | 51 | 2 | 28 | 0.047 | 0.032 |
| 204-1000100 | 10 | 10 | 0.393 | 8 | 0.315 | 1 | 0.039 | 7 | 100 | 21 | 300 | 70 | 2-3/4 | 28 | 0.061 | 0.041 |
| 204-1200100 | 12 | 12 | 0.472 | 10 | 0.394 | 1 | 0.039 | 6 | 80 | 18 | 240 | 76 | 3 | 28 | 0.074 | 0.050 |

Colors

- Standard is natural
- Colors available as custom run

| Color Code | | | Color Code | | |
|------------|---|---------|------------|---|--------|
| ○ | N | Natural | ● | 5 | Green |
| ● | 0 | Black | ● | 6 | Blue |
| ● | 1 | Brown | ● | 7 | Violet |
| ● | 2 | Red | ● | 8 | Gray |
| ● | 3 | Orange | ○ | 9 | White |
| ● | 4 | Yellow | | | |

WARNING

This product can expose you to chemicals including Tetrafluoroethylene, which is known to the State of California to cause cancer. For more information go to www.P65Warnings.ca.gov.

PFA Tubing - High Purity

Series 105, 205

A Hose

Series 105 - High Purity PFA Fractional Industrial Wall Tubing

| Part Number | Order Size | Nominal O.D. | | Nominal I.D. | | Reference Wall Thickness | | Working Pressure 73°F (23°C) | | Minimum Burst Pressure | | Minimum Bend Radius | | Vac. Rating | Weight | |
|-------------|------------|--------------|------|--------------|------|--------------------------|------|---------------------------------|-----|------------------------|-----|---------------------|----|-------------|---------|--------|
| | | inch | mm | inch | mm | inch | mm | psi | bar | psi | bar | inch | mm | | lb./ft. | kg./mt |
| 105-0125031 | 1/8 | 0.125 | 3.18 | 0.064 | 1.63 | 0.031 | 0.79 | 500 | 34 | 1500 | 103 | 3/8 | 10 | 28 | 0.009 | 0.013 |
| 105-0188031 | 3/16 | 0.188 | 4.78 | 0.125 | 3.18 | 0.031 | 0.79 | 320 | 22 | 960 | 66 | 5/8 | 16 | 28 | 0.014 | 0.021 |
| 105-0250031 | 1/4 | 0.250 | 6.35 | 0.188 | 4.78 | 0.031 | 0.79 | 230 | 16 | 690 | 48 | 7/8 | 22 | 28 | 0.020 | 0.030 |
| 105-0375031 | 3/8 | 0.375 | 9.52 | 0.312 | 7.92 | 0.031 | 0.79 | 140 | 10 | 420 | 29 | 3-1/4 | 83 | 28 | 0.031 | 0.046 |

Series 105 - High Purity PFA Fractional Heavy Wall Tubing

| | | | | | | | | | | | | | | | | |
|-------------|-----|-------|-------|-------|-------|-------|------|-----|----|------|----|-------|-----|----|-------|-------|
| 105-0250040 | 1/4 | 0.250 | 6.35 | 0.170 | 4.32 | 0.040 | 1.02 | 280 | 19 | 840 | 58 | 1-1/8 | 32 | 28 | 0.025 | 0.037 |
| 105-0250047 | 1/4 | 0.250 | 6.35 | 0.156 | 3.96 | 0.047 | 1.19 | 340 | 23 | 1020 | 70 | 3/4 | 19 | 28 | 0.028 | 0.042 |
| 105-0250062 | 1/4 | 0.250 | 6.35 | 0.125 | 3.18 | 0.062 | 1.57 | 470 | 32 | 1410 | 97 | 3/4 | 19 | 28 | 0.034 | 0.051 |
| 105-0375062 | 3/8 | 0.375 | 9.52 | 0.250 | 6.35 | 0.062 | 1.57 | 290 | 20 | 870 | 60 | 1-1/2 | 38 | 28 | 0.057 | 0.085 |
| 105-0500062 | 1/2 | 0.500 | 12.70 | 0.375 | 9.53 | 0.062 | 1.57 | 210 | 14 | 630 | 43 | 2-1/8 | 54 | 28 | 0.079 | 0.118 |
| 105-0750062 | 3/4 | 0.750 | 19.05 | 0.625 | 15.88 | 0.062 | 1.57 | 130 | 9 | 390 | 27 | 6 | 152 | 28 | 0.125 | 0.186 |
| 105-1000062 | 1 | 1.000 | 25.40 | 0.875 | 22.22 | 0.062 | 1.57 | 90 | 6 | 270 | 19 | 8 | 203 | 28 | 0.170 | 0.253 |

Series 205 - PFA High Purity Metric Size Tubing

| Part Number | Order Size | Nominal O.D. | | Nominal I.D. | | Reference Wall Thickness | | Working Pressure 73°F (23°C) | | Minimum Burst Pressure | | Minimum Bend Radius | | Vac. Rating | Weight | |
|-------------|------------|--------------|-------|--------------|-------|--------------------------|-------|---------------------------------|-----|------------------------|------|---------------------|-------|-------------|--------|-------|
| | | mm | inch | mm | inch | mm | inch | bar | psi | bar | psi | mm | inch | | kg/mtr | lb/ft |
| 205-0300100 | 3 | 3 | 0.118 | 1 | 0.039 | 1 | 0.039 | 27 | 390 | 81 | 1170 | 6 | 1/4 | 28 | 0.014 | 0.009 |
| 205-0400100 | 4 | 4 | 0.157 | 2 | 0.079 | 1 | 0.039 | 20 | 290 | 60 | 870 | 13 | 1/2 | 28 | 0.020 | 0.014 |
| 205-0600100 | 6 | 6 | 0.236 | 4 | 0.157 | 1 | 0.039 | 12 | 180 | 36 | 540 | 29 | 1-1/8 | 28 | 0.034 | 0.023 |
| 205-0800100 | 8 | 8 | 0.315 | 6 | 0.236 | 1 | 0.039 | 9 | 130 | 27 | 390 | 51 | 2 | 28 | 0.047 | 0.032 |
| 205-1000100 | 10 | 10 | 0.393 | 8 | 0.315 | 1 | 0.039 | 7 | 100 | 21 | 300 | 70 | 2-3/4 | 28 | 0.061 | 0.041 |
| 205-1200100 | 12 | 12 | 0.472 | 10 | 0.394 | 1 | 0.039 | 6 | 80 | 18 | 240 | 76 | 3 | 28 | 0.074 | 0.050 |

Colors

- Standard is natural
- Colors available as custom run

| Color Code | | | Color Code | | |
|------------|---|---------|------------|---|--------|
| ○ | N | Natural | ● | 5 | Green |
| ● | 0 | Black | ● | 6 | Blue |
| ● | 1 | Brown | ● | 7 | Violet |
| ● | 2 | Red | ● | 8 | Gray |
| ● | 3 | Orange | ○ | 9 | White |
| ● | 4 | Yellow | | | |

Order Information

Example: 105-0188062-NT-100

105-0188062-NT-100 – High Purity PFA

105-0188062-NT-100 – Tube O.D. in inches (3/16")

105-0188062-NT-100 – Tube Wall Thickness in inches (.062")

105-0188062-NT-100 – Natural

105-0188062-NT-100 – Bulk Tubing

105-0188062-NT-100 – Package Quantity in feet (100')



WARNING

This product can expose you to chemicals including Tetrafluoroethylene, which is known to the State of California to cause cancer. For more information go to www.P65Warnings.ca.gov.

Tubing
Fluoropolymer

Coiled Air Hose
& Fittings

Transportation

Fittings

Tooling, Equipment,
& Accessories

General Technical

Plastic Multitube Tubing Bundles

Series PJ, PJH

Bundled tubing is an ideal alternative for applications where multiple lengths of tubing are currently being installed independently.



Features

- Ideal alternative for applications where multiple lengths of tubing are currently being installed independently
- Saves space within cabled trays
- Reduces overall installation cost
- Bundles offer protection to the individual tubes while being routed throughout a plant
- Standard jacketing material - Black 105°C-rated, flame-resistant PVC
FR-PVC offers tough protection against corrosive environments, water, oils, acids and alkaline chemicals. Chemically inert
- Each tube in bundle is pressure tested prior to shipment; Plastic tubes are pressure tested using dry N₂ at 125 psi for 5 minutes*

Notes

- Other jacketing materials are available upon request
- Plastic tubes are uniquely identified using a number code printed along the entire length of each tube. Each tube is uniquely numbered, making connections fast and accurate during installation.
- *Other testing and third party certifications are available upon request. Including ABS (American Bureau of Shipbuilding), DNV (Det Norske Veritas) and Lloyds. Contact the factory for details.

Compliance*

- ABS (American Bureau of Shipbuilding)
- DNV (Det Norske Veritas)
- Lloyds

Order Information

Example: 4PJ-E0440-UB

4PJ-E0440-UB – Number of Tubes (4)

4PJ-E0440-UB – Product Design (Polymer Jacketed)

4PJ-E0440-UB – Tube Material (Polyethylene)

4PJ-E0440-UB – Tube O.D. in sixteenths of an inch (1/4")

4PJ-E0440-UB – Tube Wall Thickness in decimals (0.040")

4PJ-E0440-UB – Jacket Material (FR-PUR)

4PJ-E0440-UB – Jacket Color (Blue)

WARNING

This product can expose you to chemicals including Titanium dioxide (airborne, unbound part, 1,3-Butadiene which is known to the State of California to cause cancer and 1,3-Butadiene which is known to the State of California to cause birth defects or other reproductive harm. For more information go to www.P65Warnings.ca.gov

Nomenclature

Plastic Multitube Tubing Bundles

Series PJ, PJH



| Number of Tubes | Product Design | Tube Material | Tube Size O.D. | Tube Size Wall Thickness | Jacket Material | Jacket Color | |
|-----------------|-------------------------------------|---------------------------------------|---|--|--|---|---|
| 1 = 1 tube | PJ = Polymer, Jacketed | E = Polyethylene | Imperial | Imperial | V = FR-PVC | N = Black | |
| 2 = 2 tubes | | H = High Density Polyethylene | 02 = 1/8" | 16 = .016" 40 = .040" | T = FR-TPE | B = Blue | |
| 3 = 3 tubes | | R = FR-PE | 03 = 3/16" | 20 = .020" 47 = .047" | U = FR-PUR | G = Green | |
| 4 = 4 tubes | | N = Nylon | 04 = 1/4" | 28 = .028" 49 = .049" | P = PUR | O = Orange | |
| ect. | PJH = Polymer, Jacketed Heavy 3/16" | U = Urethane | 05 = 5/16" | 30 = .030 50 = .050" | R = TPR | Y = Yellow | |
| | | P = PFA Fluoropolymer | 06 = 3/8" | 31 = .031" 62 = .062" | E = FRPE | P = Purple | |
| | | F = FEP Fluoropolymer | 07 = 7/16" | 32 = .032" 65 = .065" | L = LDPE | R = Red | |
| | | T = TFE Fluoropolymer | 08 = 1/2" | 35 = .035" 83 = .083" | K = PVDF | W = White | |
| | | 9 = Customer Specified Tube Material. | 10 = 5/8" | | | | |
| | | | 12 = 3/4" | | | | |
| | | | 16 = 1" | | | | |
| | | | | Metric | | Note: Parflex standard jacket material is FR-PVC | Note: Parflex standard jacket material is FR-PVC |
| | | | All Tubes are black and number coded, except Fluoropolymer tubes which are all natural. | Metric | 89=.89mm 20=2.0mm 10=1.0mm 25=2.5mm 15=1.5mm | | |
| | | | Colored tubes are available upon special request" | MA = 2mm MB = 4mm MC = 6mm MD = 8mm ME = 10mm MF = 12mm | | For standard FR-PVC black, the -VN may be dropped | For standard FR-PVC black, the -VN may be dropped |

Series PJ/PJH - Multitube Bundled Tubing

| Description | Part Number | Number of Tubes | Jacket Thickness | | Nominal Product O.D. | | Minimum Bend Radius | | Maximum Pulling Tension | | Weight per 100 feet | |
|--|-------------|-----------------|------------------|------|----------------------|------|---------------------|-------|-------------------------|------|---------------------|------|
| | | | inch | mm | inch | mm | inch | mm | lbs. | kg. | lb.s | kg. |
| Polyethylene Tubes: 1/4" O.D. x .040" Wall | 2PJ-E0440 | 2 | 0.045 | 1.14 | 0.59 | 15.0 | 1.5 | 38.1 | 90 | 41 | 8.6 | 3.9 |
| | 3PJ-E0440 | 3 | 0.045 | 1.14 | 0.6 | 15.2 | 1.5 | 38.1 | 110 | 50 | 11.4 | 5.2 |
| | 4PJ-E0440 | 4 | 0.063 | 1.6 | 0.74 | 18.8 | 2 | 50.8 | 140 | 63 | 12.8 | 5.8 |
| | 5PJ-E0440 | 5 | 0.063 | 1.6 | 0.88 | 22.4 | 2 | 50.8 | 170 | 77 | 15.1 | 6.8 |
| | 7PJ-E0440 | 7 | 0.063 | 1.6 | 0.89 | 22.6 | 2.5 | 63.5 | 195 | 88 | 17.5 | 7.9 |
| | 8PJ-E0440 | 8 | 0.063 | 1.6 | 0.97 | 24.6 | 2.5 | 63.5 | 235 | 107 | 19.5 | 8.8 |
| | 10PJ-E0440 | 10 | 0.063 | 1.6 | 1.14 | 29.0 | 3 | 76.2 | 260 | 118 | 22.8 | 10.3 |
| | 12PJ-E0440 | 12 | 0.063 | 1.6 | 1.14 | 29.0 | 3.5 | 88.9 | 300 | 136 | 25.4 | 11.5 |
| | 14PJ-E0440 | 14 | 0.063 | 1.6 | 1.25 | 31.8 | 4 | 101.6 | 340 | 154 | 28.8 | 13.1 |
| | 19PJ-E0440 | 19 | 0.08 | 2 | 1.40 | 35.6 | 5 | 127.0 | 425 | 193 | 36.8 | 16.7 |
| 37PJ-E0440 | 37 | 0.08 | 2 | 1.96 | 49.8 | 9 | 228.6 | 880 | 399 | 74.5 | 33.8 | |
| Polyethylene Tubes: 3/8" O.D. x .062" Wall | 2PJ-E0662 | 2 | 0.063 | 1.6 | 0.89 | 22.6 | 2 | 50.8 | 160 | 73 | 13.9 | 6.3 |
| | 3PJ-E0662 | 3 | 0.063 | 1.6 | 0.89 | 22.6 | 2 | 50.8 | 195 | 88 | 17.9 | 8.1 |
| | 4PJ-E0662 | 4 | 0.063 | 1.6 | 1.05 | 26.7 | 2.5 | 63.5 | 265 | 120 | 21.1 | 9.6 |
| | 5PJ-E0662 | 5 | 0.063 | 1.6 | 1.16 | 29.5 | 3 | 76.2 | 295 | 134 | 24.6 | 11.2 |
| | 7PJ-E0662 | 7 | 0.08 | 2 | 1.31 | 33.3 | 4 | 101.6 | 365 | 166 | 29.7 | 13.5 |
| | 10PJ-E0662 | 10 | 0.08 | 2 | 1.72 | 43.7 | 5 | 127.0 | 515 | 234 | 44.2 | 20.0 |
| | 12PJ-E0662 | 12 | 0.08 | 2 | 1.80 | 45.7 | 6 | 152.4 | 685 | 311 | 60.8 | 27.6 |
| | 19PJ-E0662 | 19 | 0.08 | 2 | 2.13 | 54.1 | 10 | 254.0 | 900 | 408 | 85.5 | 38.8 |

WARNING

This product can expose you to chemicals including Titanium dioxide (airborne, unbound part, 1,3-Butadiene which is known to the State of California to cause cancer and 1,3-Butadiene which is known to the State of California to cause birth defects or other reproductive harm. For more information go to www.P65Warnings.ca.gov



Retractable Coiled Tubing

Fast-Stor®

NoMar® Fast-Stor®

FEP/PFA

Table of Contents

A Hose

RETRACTABLE COILED TUBING

FITTINGS

Intro, Parflex Air Hose..... C-3

Fast-Stor® Air Hose..... C-4

NoMar® Fast-Stor® Air Hose C-7

Fluoropolymer Coils - FEP/PFA..... C-8

Fast-Stor® Fittings C-5

How To Assemble C-6

B Tubing
Thermoplastic

C Coiled Air Hose
& Fittings

Visual Index

Retractable Coils

| Fast-Stor® | Nomar® Fast-Stor® | FEP/PFA Coils |
|---|---|---|
|  |  |  |
| C-4 | C-7 | C-8 |

D Transportation

Fittings

Fast-Stor® Male



E Fittings

F Tooling, Equipment,
& Accessories

G General Technical

Parflex Air Hose

Nylon and 95 Durometer Polyurethane

Every hydraulic, pneumatic and lubrication system requires some form of tube line fabrication and fitting installation for completion. Proper fabrication and installation are essential for the overall efficiency, leak free performance, and general appearance of any system.

Start by planning ahead. After sizing the tube lines and selecting the appropriate style of fitting, consider the following in the design of your system:

- Accessibility of joints
- Adequate tube line supports
- Proper routing of lines
- Available fabricating tools

Routing of Lines

- Routing of lines is probably the most difficult, yet most significant, of these system design considerations. Proper routing involves getting a connecting line from one point to another through the most logical path.
- Always try to leave fitting joints as accessible as possible. Hard to reach

joints are hard to assemble and tighten properly. Inaccessible joints are also more difficult and time consuming to service.

Size Selection Procedure

1. Determine air flow rate and pressure required by following air-tool manufacturers recommendations.
2. Refer to "Air Flow Characteristics" graphs, shown below. Find air flow requirement in standard cubic feet per minute (SCFM) on vertical line to left of graph. Now follow horizontal line on same graph to determine total extended length of hose required. Follow vertical line above hose length to intersection with the horizontal air flow SCFM line.
3. Note pressure drop above curve nearest to intersection of SCFM and hose length lines. Pressure drop, subtracted from line pressure, equals "available pressure" at the selected SCFM flow rate and hose length.
4. If "available pressure" is below the tool manufacturers' recommendations, refer to chart for successively larger hose sizes until an acceptable "available pressure" is found. Choose this size Fast-Stor® Air Hose for your application.
5. Refer to "working pressure vs. temperature" chart (pg. B-7) to be sure your application falls within the working range of Fast-Stor® Air Hose.

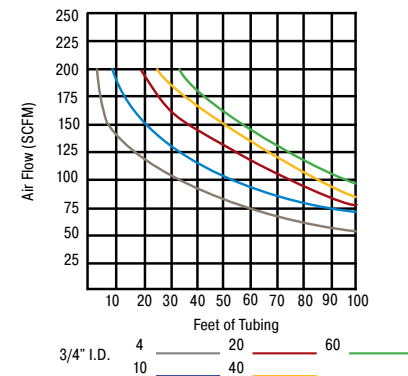
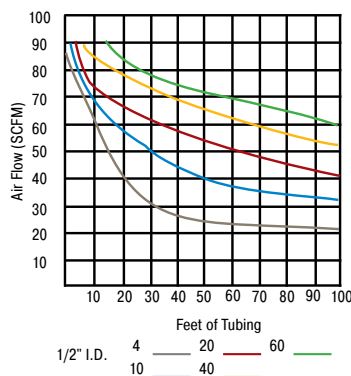
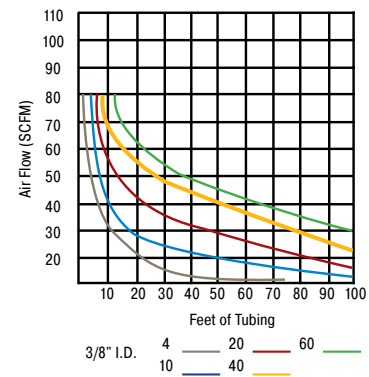
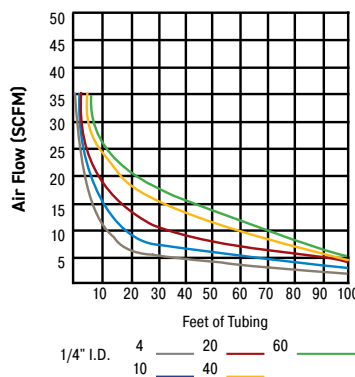
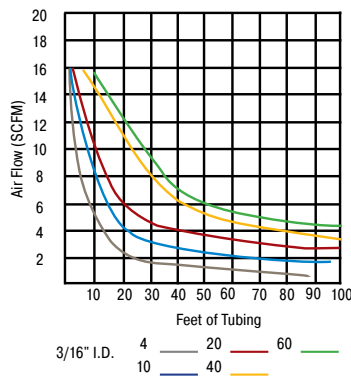

Actual working pressure charts are located in the tubing section on the specific product page.

Fast-Stor® Air Hose

Nylon

Manufactured from tough, abrasion-resistant nylon.



Features

- Excellent memory characteristics over a wide temperature range
- Long service life in rugged applications
- Safety yellow color per U.S. Government OSHA directives
- Spring guard protection at fitting connections

Fittings

- Parker Fittings available from:
Fluid System Connectors Division
Otsego, MI
- (269) 692-6555
(269) 692-6634 FAX
parker.com/fsc

Order Information

Example: NFS-04-012

NFS-04-012 – Air Hose

NFS-04-012 – Tube I.D. in sixteenths of an inch (1/4")

NFS-04-012 – Unit Length in feet (12')

Notes

- Color: Yellow
- Retail packaging standard for all coiled assemblies
- Service temperature range: -40°F (-40°C) to 200°F (93°C)
- *Maximum working pressure based on design factor of 3:1
- Pre-applied thread sealant on all fittings
- NPT swivel standard on each end of assembly
- Fittings for Fast-Stor hose are constructed from heavy duty brass with built in tube insert



Series NFS Fast-Stor

| Assembly Part Number | Tube O.D. | | Tube I.D. | | Nominal Coil O.D. | | Unit Length | | Extended Length | | Nominal Compact Length | | Working Pressure* | | Minimum Burst Pressure* | | End Fittings | Color | |
|----------------------|-----------|----|-----------|----|-------------------|-----|-------------|------|-----------------|------|------------------------|-----|-------------------|------|-------------------------|------|--------------|-------|--|
| | inch | mm | inch | mm | inch | mm | ft | mtr | ft | mtr | inch | mm | psi | bar | psi | bar | | | |
| Assemblies | | | | | | | | | | | | | | | | | | | |
| NFS-04-012 | 5/16 | 8 | 1/4 | 6 | 3-1/2 | 89 | 12 | 3.7 | 9.0 | 2.7 | 4-1/2 | 114 | 240 | 16.5 | 720 | 49.6 | 1/4" NPT | ● | |
| NFS-04-025 | | | | | | | 25 | 7.6 | 18.8 | 5.7 | 9 | 229 | | | | | | ● | |
| NFS-04-050 | | | | | | | 50 | 15.2 | 37.5 | 11.4 | 18 | 457 | | | | | | ● | |
| NFS-06-012 | 15/32 | 12 | 3/8 | 10 | 5-1/2 | 140 | 12 | 3.7 | 9.0 | 2.7 | 4-1/2 | 114 | 225 | 15.5 | 675 | 46.5 | 3/8" NPT | ● | |
| NFS-06-025 | | | | | | | 25 | 7.6 | 18.8 | 5.7 | 9 | 229 | | | | | | ● | |
| NFS-06-050 | | | | | | | 50 | 15.2 | 37.5 | 11.4 | 18 | 457 | | | | | | ● | |
| NFS-08-012 | 5/8 | 16 | 1/2 | 13 | 8 | 203 | 12 | 3.7 | 9.0 | 2.7 | 4-1/2 | 114 | 220 | 15.2 | 660 | 45.5 | 1/2" NPT | ● | |
| NFS-08-025 | | | | | | | 25 | 7.6 | 18.8 | 5.7 | 8 | 203 | | | | | | ● | |
| NFS-08-050 | | | | | | | 50 | 15.2 | 37.5 | 11.4 | 17 | 431 | | | | | | ● | |
| Bulk Hose | | | | | | | | | | | | | | | | | | | |
| NFS-04-100B | 5/16 | 8 | 1/4 | 6 | 3-1/2 | 89 | 100 | 30.5 | 75 | 22.8 | 38 | 965 | 240 | 16.5 | 720 | 49.6 | - | ● | |
| NFS-06-100B | 15/32 | 12 | 3/8 | 10 | 5-1/2 | 140 | 100 | 30.5 | 75 | 22.8 | 37 | 940 | 225 | 15.5 | 675 | 46.5 | - | ● | |
| NFS-08-100B | 5/8 | 16 | 1/2 | 13 | 8 | 203 | 100 | 30.5 | 75 | 22.8 | 36 | 914 | 220 | 15.2 | 660 | 45.5 | - | ● | |



WARNING

This product can expose you to chemicals including Lead, which is known to the State of California to cause cancer and birth defects or other reproductive harm. For more information go to www.P65Warnings.ca.gov.

Fast-Stor® Fittings

Male Connections

Manufactured from heavy duty brass.



Features

- Constructed from heavy duty brass with built in insert-supports
- Fitting bodies are SAE standard sizes
- All fitting part numbers include body, nut, ferrule, tube support, and spring guard



MC – Male Connector



| Part Number | Thread Size | Hose I.D. | | L | | B Hex | | C Hex | |
|-------------|-------------|-----------|----|---------|----|-------|----|-------|----|
| | | inch | mm | inch | mm | inch | mm | inch | mm |
| # | | | | | | | | | |
| MC-04-4 | 1/4 | 1/4 | 6 | 1-9/16 | 40 | 9/16 | 14 | 9/16 | 14 |
| MC-06-6 | 3/8 | 3/8 | 10 | 1-13/16 | 46 | 11/16 | 17 | 13/16 | 21 |
| MC-08-8 | 1/2 | 1/2 | 13 | 2-1/8 | 54 | 7/8 | 22 | 15/16 | 24 |

ML – Live Male Pipe Swivel



| Part Number | Thread Size | Hose I.D. | | L | | B Hex | | C Hex | |
|-------------|-------------|-----------|----|--------|----|-------|----|-------|----|
| | | inch | mm | inch | mm | inch | mm | inch | mm |
| # | | | | | | | | | |
| ML-04-4 | 1/4 | 1/4 | 6 | 1-9/16 | 40 | 9/16 | 14 | 9/16 | 14 |
| ML-06-6 | 3/8 | 3/8 | 10 | 1-7/8 | 47 | 3/4 | 19 | 13/16 | 21 |
| ML-08-8 | 1/2 | 1/2 | 13 | 2-3/8 | 60 | 5/8 | 22 | 15/16 | 24 |

WARNING

This product can expose you to chemicals including Lead, which is known to the State of California to cause cancer and birth defects or other reproductive harm. For more information go to www.P65Warnings.ca.gov.

Fast-Stor® Fittings

How to Assemble

A Hose

Manufactured from heavy duty brass.



B Tubing
Thermoplastic

How To Assemble Fast-Stor Hose

1. Using a Parker PTC or HTC hand cutter or other sharp cutter, cut hose squarely to correct length
2. Install SG spring guard on hose as shown
3. Slide FN nut on hose followed by FR plastic ferrule with the taper side of the ferrule toward the cut end of the hose
4. Insert TS tube support
5. Push hose into fitting body until bottomed. Slide nut and ferrule up to fitting body and tighten nut by hand. With a wrench, tighten the nut an additional 2 to 2-1/2 turns
6. Slide spring guard over nut until the lead coil snaps between the nut and fitting body hex

OBSOLETE

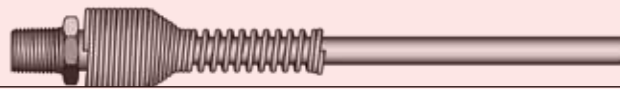
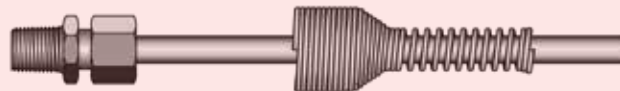
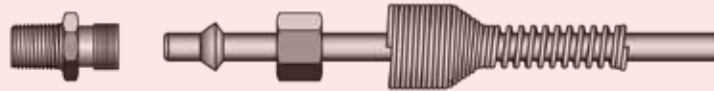
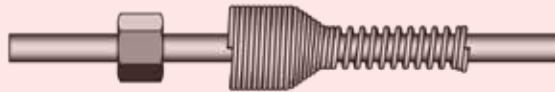

WARNING

This product can expose you to chemicals including Lead, which is known to the State of California to cause cancer and birth defects or other reproductive harm. For more information go to www.P65Warnings.ca.gov.

C Coiled Air Hose
& Fittings

D Transportation

E Fittings

F Tooling, Equipment,
& Accessories

G General Technical

NoMar® Fast-Stor® Air Hose

95 Durometer Polyurethane

Excellent abrasion and kink resistance.



Features

- 95 Shore A durometer
- Constructed from non-marring, UV resistant polyurethane
- Excellent abrasion and kink resistance

Notes

- Service temperature range: -40°F (-40°C) to 180°F (82°C)
- Pigtail - 8" and 16" with NPT swivel on each end
- Pre-applied thread sealant on all fittings
- Retail packaging standard for all coils
- Extended length approximately 92% of unit length

Colors

Color Code

| | | |
|---------------------------------------|-----|-------------|
| ● | TBL | Trans. Blue |
| ● | BLK | Black |
| ● | BLU | Blue |
| ● | RED | Red |
| ● | YEL | Yellow |

Order Information

Example: **95UFS-64-TBL-025**

95UFS-64-TBL-025 – Assembled Urethane Fast-Stor

95UFS-64-TBL-025 – Tube O.D. in sixteenths of an inch (3/8")

95UFS-64-TBL-025 – Hose I.D. in sixteenths of an inch (1/4")

95UFS-64-TBL-025 – Color TBL = Transparent Blue

95UFS-64-TBL-025 – Unit Length (25')

Polyurethane Air Hose (Series 95UFS)

Maximum Working Pressure (psig)

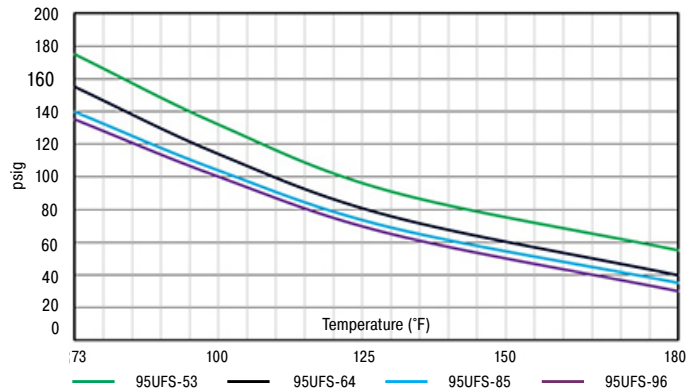

Series NoMar Fast-Stor Assemblies

| Assembly Part Number | Hose O.D. | | Hose I.D. | | Nominal Coil O.D. | Unit Length | | Extended Length | | Nominal Compact Length | Working Pressure 73°F (23°C) | Minimum Burst Pressure | End Fittings | Colors | | | |
|----------------------|-----------|----|-----------|----|-------------------|-------------|-----|-----------------|------|------------------------|------------------------------|------------------------|--------------|--------|------|------|-----------------|
| | inch | mm | inch | mm | | ft | mtr | ft | mtr | | | | | | inch | mm | psi |
| 95UFS-53-XXX-010 | 5/16 | 8 | 3/16 | 5 | 1-5/8 | 41 | 10 | 3.0 | 9.2 | 2.8 | 7 1/2 | 190 | 175 | 12.1 | 525 | 36.2 | 1/4" NPT swivel |
| 95UFS-53-XXX-025 | | | | | | | 25 | 7.6 | 23.0 | 7.0 | 21-1/2 | 546 | | | | | |
| 95UFS-64-XXX-010 | 3/8 | 10 | 1/4 | 6 | 2-1/2 | 64 | 10 | 3.0 | 9.2 | 2.8 | 5-1/2 | 140 | 155 | 10.7 | 465 | 32.1 | 1/4" NPT swivel |
| 95UFS-64-XXX-015 | | | | | | | 15 | 4.6 | 13.8 | 4.2 | 9 | 229 | | | | | |
| 95UFS-64-XXX-020 | | | | | | | 20 | 6.1 | 18.4 | 5.6 | 13 | 330 | | | | | |
| 95UFS-64-XXX-025 | | | | | | | 25 | 7.6 | 23.0 | 7.0 | 16 | 406 | | | | | |
| 95UFS-85-XXX-010 | 15/32 | 12 | 5/16 | 8 | 3-3/16 | 81 | 10 | 3.0 | 9.2 | 2.8 | 5-1/2 | 140 | 140 | 9.7 | 420 | 29.0 | 3/8" NPT swivel |
| 95UFS-85-XXX-015 | | | | | | | 15 | 4.6 | 13.8 | 4.2 | 8-1/2 | 216 | | | | | |
| 95UFS-85-XXX-020 | | | | | | | 20 | 6.1 | 18.4 | 5.6 | 12-1/2 | 318 | | | | | |
| 95UFS-85-XXX-025 | | | | | | | 25 | 7.6 | 23.0 | 7.0 | 15-1/2 | 394 | | | | | |
| 95UFS-96-XXX-010 | 9/16 | 14 | 3/8 | 10 | 3-5/8 | 92 | 10 | 3.0 | 9.2 | 2.8 | 6 | 152 | 135 | 9.3 | 405 | 27.9 | 3/8" NPT swivel |
| 95UFS-96-XXX-015 | | | | | | | 15 | 4.6 | 13.8 | 4.2 | 9-1/2 | 241 | | | | | |
| 95UFS-96-XXX-020 | | | | | | | 20 | 6.1 | 18.4 | 5.6 | 13-1/2 | 343 | | | | | |
| 95UFS-96-XXX-025 | | | | | | | 25 | 7.6 | 23.0 | 7.0 | 17 | 432 | | | | | |



WARNING

This product can expose you to chemicals including Lead, which is known to the State of California to cause cancer and birth defects or other reproductive harm. For more information go to www.P65Warnings.ca.gov.

Fluoropolymer Retractable Coil Tubing

703 FEP - 704, 705 PFA

Excellent flexibility, clarity and chemical resistance.



Features

- Extremely flexible
- Excellent clarity
- Chemically inert
- Low coefficient of friction
- Self extinguishing
- Non-wetting
- Available in FEP, PFA and High Purity PFA

Compliance

- FEP - ASTM D3296
- PFA - ASTM D3307
- FDA Compliant
- USP Class VI

Colors

- ○ Natural, translucent

Notes

- Service temperature range: -100°F (-75°C) to 200°F (93°C)
For higher temperatures, request PFA -100°F (-75°C) to 300°F (148°C)
Above these temperatures, the coils dimensions are not stable and the coils will lose their shape
- Wall thickness of tubing .062"/1.57mm
- Part number nomenclature - Use prefix 703 for FEP, 704 for PFA and 705 for HP PFA
- Standard left/right tail length is 6 inches

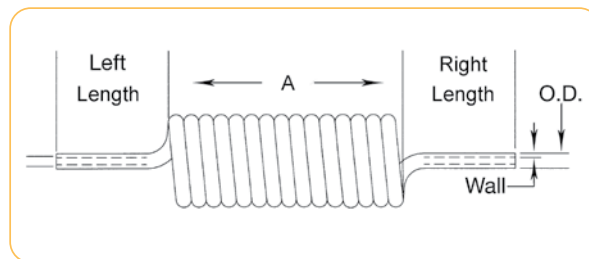

Fittings

Parker Fittings available from:
Fluid System Connectors Division
Otsego, MI

(269) 692-6555
(269) 692-6634 FAX
parker.com/fsc

For approved fittings and/or suggested use of tube supports, reference Tube/Fitting Compatibility Chart (pg. B-8/B-9) or contact Parker Fluid Systems Connectors Division

Order Information

Example: 704-0312062-xx0012

704-0312062-xx0012 – Retractable Tubing

704-0312062-xx0012 – PFA

704-0312062-xx0012 – Tube O.D. in inches (3/16")

704-0312062-xx0012 – Tube Wall Thickness in inches (.062")

704-0312062-xx0012 – Custom Options (as required)

704-0312062-xx0012 – Length in inches (12")

WARNING

This product can expose you to chemicals including Tetrafluoroethylene, which is known to the State of California to cause cancer. For more information go to www.P65Warnings.ca.gov.

Fluoropolymer Retractable Coil Tubing

Series 703 FEP

Series 703 - FEP Retractable Coil Tubing

| Part Number | Tube O.D. | | Tube I.D. | | Nominal Coil O.D. | | Extended Length | | Nominal Compact Length | | Working Pressure 73°F (23°C) | | Colors |
|--------------------|-----------|-------|-----------|------|-------------------|-----|-----------------|------|------------------------|-----|------------------------------|-----|--------|
| | inch | mm | inch | mm | inch | mm | inch | mm | inch | mm | psi | bar | |
| 703-0250062-xx0003 | 1/4 | 6.35 | 1/8 | 3.18 | 1-1/2 | 38 | 12 | 305 | 3 | 76 | 375 | 25 | ○ |
| 703-0250062-xx0006 | | | | | | | 24 | 610 | 6 | 152 | | | ○ |
| 703-0250062-xx0012 | | | | | | | 48 | 1219 | 12 | 305 | | | ○ |
| 703-0250062-xx0018 | | | | | | | 72 | 1829 | 18 | 457 | | | ○ |
| 703-0375062-xx0003 | 3/8 | 9.68 | 1/4 | 6.35 | 2-3/8 | 60 | 12 | 305 | 3 | 76 | 240 | 16 | ○ |
| 703-0375062-xx0006 | | | | | | | 24 | 610 | 6 | 152 | | | ○ |
| 703-0375062-xx0012 | | | | | | | 48 | 1219 | 12 | 305 | | | ○ |
| 703-0375062-xx0018 | | | | | | | 72 | 1829 | 18 | 457 | | | ○ |
| 703-0500062-xx0003 | 1/2 | 12.88 | 3/8 | 9.68 | 4 | 102 | 12 | 305 | 3 | 76 | 175 | 12 | ○ |
| 703-0500062-xx0006 | | | | | | | 24 | 610 | 6 | 152 | | | ○ |
| 703-0500062-xx0012 | | | | | | | 48 | 1219 | 12 | 305 | | | ○ |

Series 704 - PFA Retractable Coil Tubing

| Part Number | Tube O.D. | | Tube I.D. | | Nominal Coil O.D. | | Extended Length | | Nominal Compact Length | | Working Pressure 73°F (23°C) | | Colors |
|--------------------|-----------|-------|-----------|------|-------------------|-----|-----------------|------|------------------------|-----|------------------------------|-----|--------|
| | inch | mm | inch | mm | inch | mm | inch | mm | inch | mm | psi | bar | |
| 704-0250062-xx0003 | 1/4 | 6.35 | 1/8 | 3.18 | 1-1/2 | 38 | 12 | 305 | 3 | 76 | 375 | 25 | ○ |
| 704-0250062-xx0006 | | | | | | | 24 | 610 | 6 | 152 | | | ○ |
| 704-0250062-xx0012 | | | | | | | 48 | 1219 | 12 | 305 | | | ○ |
| 704-0250062-xx0018 | | | | | | | 72 | 1829 | 18 | 457 | | | ○ |
| 704-0375062-xx0003 | 3/8 | 9.68 | 1/4 | 6.35 | 2-3/8 | 60 | 12 | 305 | 3 | 76 | 240 | 16 | ○ |
| 704-0375062-xx0006 | | | | | | | 24 | 610 | 6 | 152 | | | ○ |
| 704-0375062-xx0012 | | | | | | | 48 | 1219 | 12 | 305 | | | ○ |
| 704-0375062-xx0018 | | | | | | | 72 | 1829 | 18 | 457 | | | ○ |
| 704-0500062-xx0003 | 1/2 | 12.88 | 3/8 | 9.68 | 4 | 102 | 12 | 305 | 3 | 76 | 175 | 12 | ○ |
| 704-0500062-xx0006 | | | | | | | 24 | 610 | 6 | 152 | | | ○ |
| 704-0500062-xx0012 | | | | | | | 48 | 1219 | 12 | 305 | | | ○ |

Retractable Coils FEP (Series 703)
Maximum Working Pressure (psig)

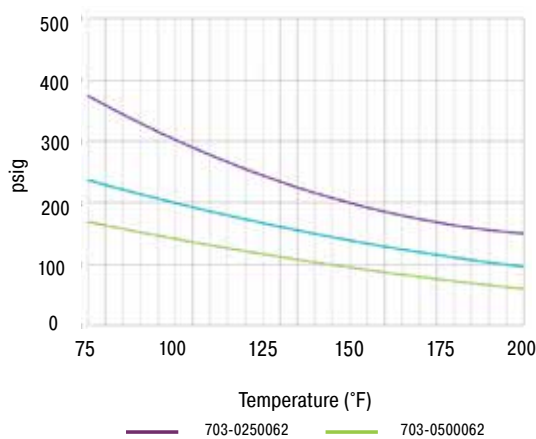

Retractable Coils PFA (Series 704)
Maximum Working Pressure (psig)

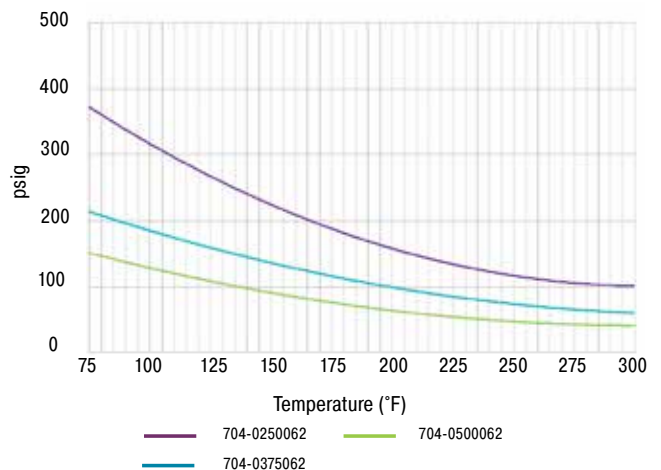

WARNING

This product can expose you to chemicals including Tetrafluoroethylene, which is known to the State of California to cause cancer. For more information go to www.P65Warnings.ca.gov.

Fluoropolymer Retractable Coil Tubing

Series 705 High Purity PFA

A Hose

Series 705 - High Purity PFA Retractable Coil Tubing

| Part Number | Tube O.D. | | Tube I.D. | | Nominal Coil O.D. | | Extended Length | | Nominal Compact Length | | Working Pressure 73°F (23°C) | | Colors |
|--------------------|-----------|-------|-----------|------|-------------------|-----|-----------------|------|------------------------|-----|------------------------------|-----|--------|
| | inch | mm | inch | mm | inch | mm | inch | mm | inch | mm | psi | bar | |
| 704-0250062-xx0003 | 1/4 | 6.35 | 1/8 | 3.18 | 1-1/2 | 38 | 12 | 305 | 3 | 76 | 420 | 28 | ○ |
| 704-0250062-xx0006 | | | | | | | 24 | 610 | 6 | 152 | | | ○ |
| 704-0250062-xx0012 | | | | | | | 48 | 1219 | 12 | 305 | | | ○ |
| 704-0250062-xx0018 | | | | | | | 72 | 1829 | 18 | 457 | | | ○ |
| 704-0375062-xx0003 | 3/8 | 9.68 | 1/4 | 6.35 | 2-3/8 | 60 | 12 | 305 | 3 | 76 | 200 | 13 | ○ |
| 704-0375062-xx0006 | | | | | | | 24 | 610 | 6 | 152 | | | ○ |
| 704-0375062-xx0012 | | | | | | | 48 | 1219 | 12 | 305 | | | ○ |
| 704-0375062-xx0018 | | | | | | | 72 | 1829 | 18 | 457 | | | ○ |
| 704-0500062-xx0003 | 1/2 | 12.88 | 3/8 | 9.68 | 4 | 102 | 12 | 305 | 3 | 76 | 150 | 10 | ○ |
| 704-0500062-xx0006 | | | | | | | 24 | 610 | 6 | 152 | | | ○ |
| 704-0500062-xx0012 | | | | | | | 48 | 1219 | 12 | 305 | | | ○ |

B Tubing Thermoplastic

C Coiled Air Hose & Fittings

D Transportation

E Fittings

F Tooling, Equipment, & Accessories

G General Technical

Retractable Coils High Purity PFA (Series 705)
Maximum Working Pressure (psig)

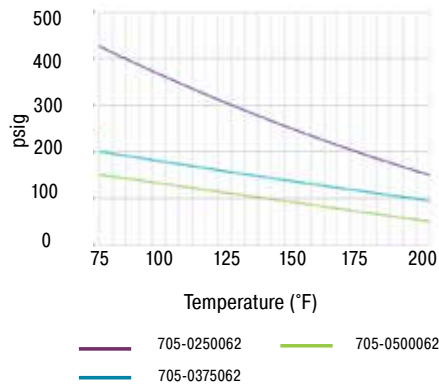

WARNING

This product can expose you to chemicals including Tetrafluoroethylene, which is known to the State of California to cause cancer. For more information go to www.P65Warnings.ca.gov.



TRANSPORTATION

Air Brake Tubing
Diesel Fuel Tubing

Tractor-to-Tractor Coils

DEF Transfer

Table of Contents

INTRO

Transportation Products..... D-3

NOMENCLATURE D-4



TUBING

Air Brake D-5

Custom Transportation Tubing.....D-11

Diesel Fuel..... D-7

HOSE

SCR Hose for DEF Dosing Systems..... D-12

TRACTOR-TO-TRAILER COILS

BrakeCoil® D-9

Fifth Wheel Slider..... D-10

A Hose

B Tubing
Thermoplastic

C Coiled Air Hose
& Fittings

D Transportation

E Fittings

F Tooling, Equipment,
& Accessories

G General Technical

Parflex Transportation Products

On-Vehicle Index

A
Hose

B
Tubing
Thermoplastic

C
Coiled Air Hose
& Fittings

D
Transportation

E
Fittings

F
Tooling, Equipment
& Accessories

G
General Technical

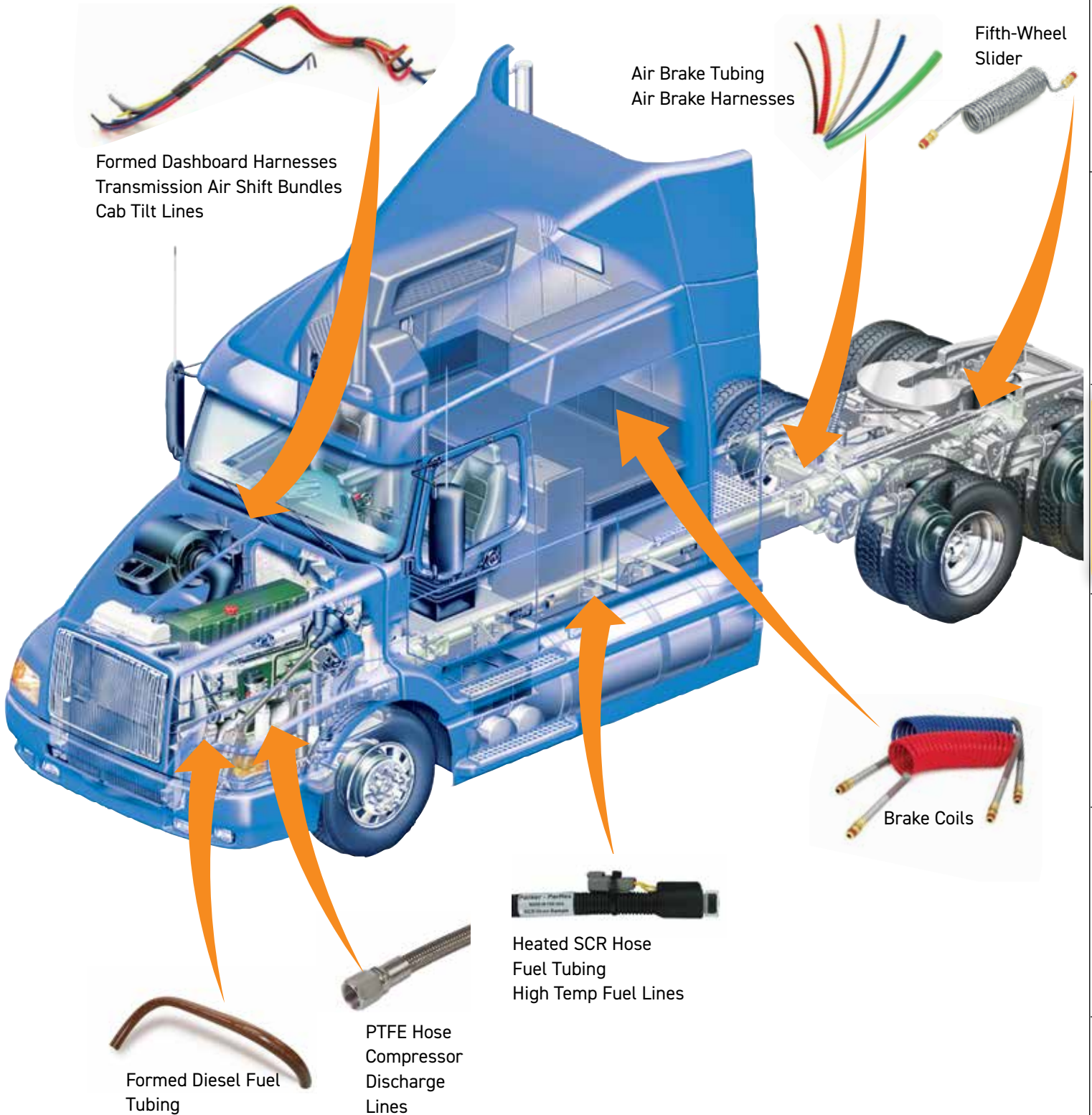

Formed Dashboard Harnesses
Transmission Air Shift Bundles
Cab Tilt Lines

Air Brake Tubing
Air Brake Harnesses

Fifth-Wheel
Slider

Brake Coils

Heated SCR Hose
Fuel Tubing
High Temp Fuel Lines

PTFE Hose
Compressor
Discharge
Lines

Formed Diesel Fuel
Tubing

Nomenclature

Transportation Tubing

Nylon: Series Air Brake, Diesel Fuel

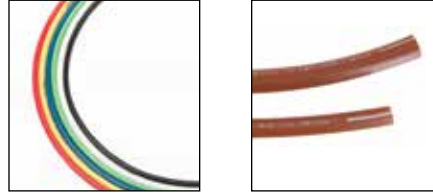

| Product Family | Tube Size O.D. | Tube Type | Tubing Color* |
|-------------------------------------|----------------|---|---------------|
| 1120 = Airbrake | 2 = 0.125 | A = Single-wall extruded Nylon (polyamide) | BLK = Black |
| PFT = Airbrake or Diesel Fuel | 2.5 = 0.156 | | BLU = Blue |
| HTFL = High Temperature Diesel Fuel | 3 = 0.188 | B = Nylon (polyamide) core, fiber reinforcement, Nylon (polyamide) cover/sheath | BRN = Brown |
| | 4 = 0.250 | | GRN = Green |
| | 5 = 0.313 | | ORG = Orange |
| | 6 = 0.375 | | PUR = Purple |
| | 8 = 0.500 | | RED = Red |
| | 10 = 0.625 | | SIL = Silver |
| | 12 = 0.750 | | TAN = Tan |
| | | | YEL = Yellow |
| | | | WHT = White |

Note: If color not specified in the product table, contact Parflex Division for availability

| Tube Packaging | Options Designator |
|---------------------|-------------------------|
| 100 = 100 ft reel | FL = Diesel Fuel Tubing |
| 500 = 500 ft reel | |
| 1000 = 1000 ft reel | |

Example: 1120-4A-RED-1000

- 1120-4A-RED-1000 – Air Brake Tubing
- 1120-4A-RED-1000 – Tube O.D. in sixteenths of an inch (1/4")
- 1120-4A-RED-1000 – Tube Type Single wall
- 1120-4A-RED-1000 – Color Red
- 1120-4A-RED-1000 – Package Quantity in feet (1000')

The "PFT" series is used as standard for air brake tubing in -2, -2.5, -3 and -5. It is also used with Diesel Fuel Tubing (PFT-FL)

Example: PFT-6B-BLU-500-FL

- PFT-6B-BLU-500-FL – Diesel Fuel Tubing*
- PFT-6B-BLU-500-FL – Tube O.D. in sixteenths of an inch (3/8")
- PFT-6B-BLU-500-FL – Tube Type Reinforced and Jacketed
- PFT-6B-BLU-500-FL – Color Blue
- PFT-6B-BLU-500-FL – Package Quantity in feet (500')
- PFT-6B-BLU-500-FL – *Designator for Diesel Fuel Tubing

Air Brake Tubing

Series 1120, PFT

Parflex makes enough airbrake tubing every year to circle the globe twice.

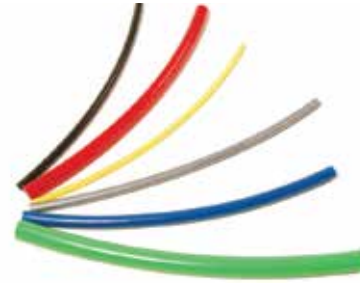

Features

- 100% pressure tested
- Excellent UV stability
- Kink resistant
- Produced from abrasion resistant, heat and light stabilized Nylon resin
- EZ pack (100') boxes available

Notes

- *2A, 3A, and 5A are not DOT sizes
- Material:
Type A – Single-wall extruded Nylon (polyamide)
Type B – Nylon (polyamide) core, fiber reinforcement, Nylon (polyamide) cover/sheath
- The operating temperature range for service at rated pressures is -40°F (-40°C) to 200°F (93°C)
- Working pressure 150 psi (10.3 bar) at 73°F (23°C)

Compliance

- SAE-J844
- DOT FMVSS 49CFR 571.106
- 2A, 3A, & 5A are not DOT sizes

Colors

| Color Code | | |
|------------|-----|--------|
| ● | BLK | Black |
| ● | BLU | Blue |
| ● | BRN | Brown |
| ● | GRN | Green |
| ● | ORG | Orange |
| ● | PUR | Purple |
| ● | RED | Red |
| ● | SIL | Silver |
| ● | TAN | Tan |
| ● | YEL | Yellow |
| ○ | WHT | White |

Fittings

- Parker Fittings available from:
Fluid System Connectors Division
Otsego, MI
- (269) 692-6555
(269) 692-6634 FAX
parker.com/fsc
- For approved fittings and/or suggested use of tube supports, reference Tube/Fitting Compatibility Chart (pg. B-8/B-9) or contact Parker Fluid Systems Connectors Division

Example: 1120-6B-RED-500

1120-6B-RED-500 – Air Brake Tubing

1120-6B-RED-500 – Tube O.D. in sixteenths of an inch (3/8")

1120-6B-RED-500 – Tube Type Reinforced and Jacketed

1120-6B-RED-500 – Color Red

1120-6B-RED-500 – Package Quantity in feet (500')

The "PFT" series is used as standard for air brake tubing in -2, -2.5, -3 and -5. It is also used with Diesel Fuel Tubing (PFT-FL)



WARNING

This product can expose you to chemicals including Nickel compounds, which is known to the State of California to cause cancer. For more information go to www.P65Warnings.ca.gov.

Air Brake Tubing

Series 1120, PFT

Series 1120, PFT - Airbrake Tubing

| Part Number | Tube O.D. | | Tube I.D. | | Nominal Wall Thickness | | Minimum Burst Pressure | | Minimum Bend Radius | | Weight | | Color |
|------------------|-----------|------|-----------|------|------------------------|-----|------------------------|------|---------------------|------|----------|--------|---------------------|
| | inch | mm | inch | mm | inch | mm | psi | bar | inch | mm | lbs./ft. | kg/mtr | |
| PFT-2A-XXX-1000* | 1/8 | 3.2 | .079 | 2.0 | .023 | 0.6 | 1000 | 68.9 | 3/8 | 9.5 | .003 | .005 | ● |
| PFT-2.5-XXX-250 | 5/32 | 4.0 | .092 | 2.3 | .032 | 0.8 | 1200 | 82.7 | 1/2 | 12.5 | .006 | .008 | ● |
| PFT-3A-XXX-1000* | 3/16 | 4.8 | .118 | 3.0 | .035 | 0.9 | 1200 | 82.7 | 3/4 | 19.0 | .008 | .011 | ● |
| 1120-4A-XXX-1000 | 1/4 | 6.4 | .170 | 4.3 | .040 | 1.0 | 1200 | 82.7 | 1 | 25.5 | .012 | .018 | ● |
| 1120-4A-XXX-100 | | | | | | | | | | | | | ● |
| PFT-5A-XXX-500* | 5/16 | 7.9 | .232 | 5.9 | .040 | 1.0 | 1000 | 68.9 | 1-1/4 | 32.0 | .016 | .023 | ● |
| 1120-6B-XXX-100 | 3/8 | 9.5 | .251 | 6.4 | .062 | 1.6 | 1400 | 96.5 | 1-1/2 | 38.0 | .027 | .040 | ● ● ● ● ● ● ● ● ● ● |
| 1120-6B-XXX-500 | | | | | | | | | | | | | ● |
| 1120-8B-XXX-100 | 1/2 | 12.7 | .376 | 9.6 | .062 | 1.6 | 950 | 65.5 | 2 | 51.0 | .039 | .058 | ● ● ● ● ● ● ● ● ● ● |
| 1120-8B-XXX-500 | | | | | | | | | | | | | ● ● ● ● ● ● ● ● ● ● |
| 1120-10B-XXX-250 | 5/8 | 15.9 | .441 | 11.2 | .092 | 2.3 | 900 | 62.1 | 2-1/2 | 63.5 | .070 | .104 | ● ● ● ● ● ● ● ● ● ● |
| 1120-12B-XXX-250 | 3/4 | 19.1 | .566 | 14.4 | .092 | 2.3 | 800 | 55.2 | 3 | 76.0 | .086 | .128 | ● ● ● ● ● ● ● ● ● ● |

Note: *2A, 3A, and 5A are not DOT sizes
-0100: 100' qty in EZ pack box



Series 1120, PFT - Airbrake Tubing Pallet Quantities

| Part Number | Standard Pallet | |
|-------------|-----------------|------|
| | ft | mtr |
| PFT-2A | 24000 | 7315 |
| PFT-2.5 | 24000 | 7315 |
| PFT-3A | 24000 | 7315 |
| 1120-4A | 24000 | 7315 |
| PFT-5A | 12000 | 3658 |
| 1120-6B | 12000 | 3658 |
| 1120-8B | 6000 | 1828 |
| 1120-10B | 3000 | 914 |
| 1120-12B | 3000 | 914 |



WARNING
 This product can expose you to chemicals including Nickel compounds, which is known to the State of California to cause cancer. For more information go to www.P65Warnings.ca.gov.

Diesel Fuel Tubing

Series PFT-FL, HTFL

Light weight tubing saves weight and installation labor in comparison to hose and hard-line tubing.



Features

- Designed for use in tractor, trailer and other mobile fuel systems
- Heat and light stabilized
- 100% pressure tested
- Light weight - saves weight and labor in comparison with hose and hard-line tubing
- HTFL for use in high temperature applications and available in pre-formed tubes for quicker installations

PFT-FL Notes

- Material: Heat and light stabilized Nylon
- Compatible with JP-5 (MIL-DTL-5624) and JP-8 (MIL-DTL-83133)
- The operating temperature range for service at rated pressures is -40°F (-40°C) to 200°F (93°C)
- Working pressure 150 psi (10.3 bar) at 73°F (23°C)
- Working pressure and burst pressure are at 73°F (23°C)

HTFL Notes

- Material: Heat and light stabilized Nylon
- Compatible with JP-5 (MIL-DTL-5624) and JP-8 (MIL-DTL-83133)
- Compatible with Biodiesel per Parflex PPB PL-18 hard-line tubing
- The operating temperature range for service at rated pressures is -50°F (-46°C) to +266°F (130°C)
- Working pressure and burst pressure are at 73°F (23°C)
- Vacuum rating at 28 inch Hg

Fittings

- Parker Fittings available from:
Fluid System Connectors Division
Otsego, MI
- (269) 692-6555
(269) 692-6634 FAX
parker.com/fsc
- For approved fittings and/or suggested use of tube supports, reference Tube/Fitting Compatibility Chart (pg. B-8/B-9) or contact Parker Fluid Systems Connectors Division

Colors

- PFT-FL ● Blue
- HTFL ● Brown

Order Information

Example: PFT-6B-BLU-0500-FL

PFT-6B-BLU-0500-FL – Diesel Fuel Tubing*

PFT-6B-BLU-0500-FL – Tube O.D. in sixteenths of an inch (3/8")

PFT-6B-BLU-0500-FL – Tube Type Reinforced and Jacketed

PFT-6B-BLU-0500-FL – Color Blue

PFT-6B-BLU-0500-FL – Package Quantity in feet (500')

PFT-6B-BLU-0500-FL – *Designator for Diesel Fuel Tubing

Order Information

Example: HTFL-6B-BRN-500

HTFL-6B-BRN-500 – High Temperature Diesel Fuel Tubing

HTFL-6B-BRN-500 – Tube O.D. in sixteenths of an inch (3/8")

HTFL-6B-BRN-500 – Reinforced and Jacketed

HTFL-6B-BRN-500 – Color Brown

HTFL-6B-BRN-500 – Package Quantity in feet (500')

WARNING

This product can expose you to chemicals including Nickel compounds, which is known to the State of California to cause cancer. For more information go to www.P65Warnings.ca.gov.

Diesel Fuel Tubing

Series PFT-FL, HTFL

A Hose

Series PFT-FL - Diesel Fuel Tubing

| Part Number | Nominal Tube O.D. | | Nominal Tube I.D. | | Nominal Wall I.D. | | Working Pressure 73°F(23°C) | | Minimum Burst Pressure | | Minimum Bend Radius | | Weight | | Color |
|--------------------|-------------------|------|-------------------|------|-------------------|-----|-----------------------------|------|------------------------|------|---------------------|------|----------|--------|-------|
| | inch | mm | inch | mm | inch | mm | psi | bar | psi | bar | inch | mm | lbs./ft. | kg/mtr | |
| PFT-4A-XXX-1000-FL | 1/4 | 6.4 | .170 | 4.3 | .040 | 1.0 | 150 | 10.3 | 1200 | 82.7 | 1 | 25.5 | .012 | .018 | |
| PFT-6B-XXX-500-FL | 3/8 | 9.5 | .251 | 6.4 | .062 | 1.6 | 150 | 10.3 | 1400 | 96.5 | 1-1/2 | 38.0 | .027 | .040 | ● |
| PFT-8B-XXX-500-FL | 1/2 | 12.7 | .376 | 9.6 | .062 | 1.6 | 150 | 10.3 | 950 | 65.5 | 2 | 51.0 | .039 | .058 | ● |
| PFT-10B-XXX-250-FL | 5/8 | 15.9 | .441 | 11.2 | .092 | 2.3 | 150 | 10.3 | 900 | 62.1 | 2-1/2 | 63.5 | .070 | .104 | ● |

Note: If color not referenced, contact the division for availability

B Tubing Thermoplastic

C Coiled Air Hose & Fittings

Series HTFL - High Temperature Diesel Fuel Tubing

| Part Number | Nominal Tube O.D. | | Nominal Tube I.D. | | Nominal Wall Thickness | | Working Pressure 73°F(23°C) | | Minimum Burst Pressure | | Minimum Bend Radius | | Weight | | Color |
|------------------|-------------------|------|-------------------|------|------------------------|-----|-----------------------------|------|------------------------|------|---------------------|------|----------|--------|-------|
| | inch | mm | inch | mm | inch | mm | psi | bar | inch | mm | inch | mm | lbs./ft. | kg/mtr | |
| HTFL-6B-XXX-500 | 3/8 | 9.5 | .251 | 6.4 | .062 | 1.6 | 175 | 12.1 | 1,400 | 96.5 | 1-1/2 | 38.0 | .028 | .042 | ● |
| HTFL-8B-XXX-500 | 1/2 | 12.7 | .376 | 9.6 | .062 | 1.6 | 155 | 10.7 | 950 | 65.5 | 2 | 51.0 | .039 | .058 | ● |
| HTFL-10B-XXX-250 | 5/8 | 15.9 | .441 | 11.2 | .092 | 2.3 | 140 | 9.7 | 900 | 62.1 | 2-7/8 | 73.0 | .071 | .106 | ● |

D Transportation

E Fittings



F Tooling, Equipment, & Accessories

G General Technical



WARNING

This product can expose you to chemicals including Nickel compounds, which is known to the State of California to cause cancer. For more information go to www.P65Warnings.ca.gov.

Tractor-to-Trailer Coils

Series BrakCoil®

Tractor-to-trailer
coiled connections



Features

- BrakCoil - Tractor-to-trailer coiled nylon air-brake connections
- Maintenance-free performance - will retract to its original shape even after long periods of extended use for years of city delivery and line haul testing
- Heavy-duty plated spring guards are rust-resistant for added protection
- More coils maximize working lengths
- No need for pogo sticks or spring hangers
- Color coding gives you mistake-free hook-ups - blue for service, red for emergency

Notes

- The operating temperature range for service is -40°F (-40°C) to 200°F (93°C)
- Working pressure 150 psi (10.3 bar) at 73°F (23°C)
- Working pressure and burst pressure are at 73°F (23°C)

Compliance

- DOT FMVSS 49CFR 571.106 @ -70°F to 200°F

Colors

- Blue
- Red

Order Information

BRAKCOIL®

BRAKCOIL kits are supplied complete - Parker pre-assembled, with everything needed, including spring guards and male pipe NTA brass fittings, ready to install. Special pipe thread sealant is factory applied. No cutting or assembly necessary. Just attach the gladhands (sold separately or pre-assembled). They are available in kits or as separate lines. A kit consists of both a red and blue tube assembly.

Series BrakCoil - Air Brake Connection

| Kit Part No. | Individual Coil Part No. | Tube O.D. | | Valve Tail Length | | Brass Male Ends (NPT) | | Working Length | | Number of Coils |
|--------------|--------------------------|-----------|------|-------------------|------|-----------------------|---------------|----------------|-----|-----------------|
| | | inch | mm | inch | mm | Valve inch | Gladhand inch | ft | mtr | |
| 731516 | 731512-RED 731512-BLU | 1/2 | 12.7 | 12 | 305 | 1/2 | 1/2 | 15 | 4.6 | 21-1/2 |
| 731522 | 731513-RED 731513-BLU | 1/2 | 12.7 | 40 | 1016 | 1/2 | 1/2 | 15 | 4.6 | 21-1/2 |
| 741526 | 731612-RED 731612-BLU | 1/2 | 12.7 | 40 | 1016 | 3/8 | 3/8 | 15 | 4.6 | 21-1/2 |
| 751641 | 741590-RED 741590-BLU | 1/2 | 12.7 | 6 | 152 | 1/2 | 1/2 | 12 | 3.7 | 18-1/2 |

Accessories

- Extended BRAKCOIL handle available, part no. 771164
- Gladhands available
 - Blue - Part # GH9211
 - Red - Part # GH9212



WARNING

This product can expose you to chemicals including Lead, which is known to the State of California to cause cancer and birth defects or other reproductive harm. For more information go to www.P65Warnings.ca.gov.

Tractor-to-Trailer Coils

Series Fifth Wheel Slider Coil

A Hose

Self-adjusts from 10" to fully extended 74" working length.



B Tubing Thermoplastic

Features

- Clutter-free hook-up and maintenance-free performance of adjustable length pneumatic tubing for fifth wheel sliding action
- Self-adjusts from 10" to fully extended 74" working length
- Universal, ready for immediate installation
- Coil set is strong and permanent - Even after prolonged use in fully extended position, coils will retract to shorter length without sagging and eliminating hazards of chafing and wear

Compliance

- SAE-J844 - Type A
- DOT FMVSS 49CFR 571.106

Colors

- Silver

C Coiled Air Hose & Fittings

Notes

- Constructed with 1/4" O.D. extruded Nylon, heat and light stabilized, single wall
- The operating temperature range for service at rated pressures is -40°F (-40°C) to 200°F (93°C)
- Working pressure 150 psi (10.3 bar) at 73°F (23°C)
- Working pressure and burst pressure are at 73°F (23°C)

D Transportation

Series Fifth Wheel Slider

| Part Number | Fittings | Pigtail Length | | Maximum Extended Length | | Retracted Length | |
|-------------|---------------|----------------|----|-------------------------|------|------------------|-----|
| | | inch | mm | inch | mm | inch | mm |
| 811537 | (2) 68NTA-4-4 | 2 | 51 | 74 | 1880 | 10 | 254 |

E Fittings



Order Information

Fifth Wheel Slider Coil

Part# 811537 comes complete with fittings.

WARNING

This product can expose you to chemicals including Lead, which is known to the State of California to cause cancer and birth defects or other reproductive harm. For more information go to www.P65Warnings.ca.gov.

F Tooling, Equipment, & Accessories

G General Technical

Custom Transportation Tubing

Custom Harnesses, Bundles & Formed Products

Formed products reduce installation times by up to 40%.



Features

- Preformed, pre-bundled tubing or hose custom designed to reduce installation timeimprove throughput with little to no tubing or hose scrap
- Individual tubes are pre-cut and assembled into a single unit

Options

- Color coding and/or numbering available for each tube
- Harnesses may contain any number of tube sizes ranging from 1/8" O.D. to 3/4" O.D.
- Harnesses can be supplied with special clamps, brackets and fittings to meet any need required by the customer
- Hoses - Contact Parflex Customer Service for custom formed hoses and hose assemblies



Cut Tubes

- Any tube offered by Parflex can be cut-to-length, with options for additional marking



Formed Tubes

- Tubes can be formed into shapes for ease of installation



Jacketed Bundles

- Two or more tubes can be bundled together with an extruded thermoplastic jacket



Harnesses

- Combine multiple cut tubes into a harness built specifically for your application



Formed Hoses

- Most Parflex thermoplastic hoses can be formed into application specific shapes

A Hose

B Tubing Thermoplastic

C Coiled Air Hose & Fittings

D Transportation

E Fittings

F Tooling, Equipment & Accessories

G General Technical

SCR Hose

Electrically Heated, On-vehicle DEF Dosing System Hose

Patented heated hose technology designed for heating and conveying DEF (Diesel Exhaust Fluid) throughout the SCR system on commercial vehicles.



Features

- Nylon and EPDM core tubes reinforced for strength and flexibility
- Helically-wrapped heating wires
- Extruded abrasion resistant jacket
- Heated fittings with protective overmolding
 - Protection against water ingress and damage of electrical components
 - Bolsters fitting strength and impact resistance
- Optional heat/abrasion shield
- 100% electrically tested, pressure tested, and cleaned before shipped
- Available in 12VDC, 24VDC, and unheated

Compliance

- IATF 16949
- ISO 14001
- IP6X, IPX8, and IPX9K

Notes

- Standard lengths available in 500 mm increments, ranging from 500 mm (0.5 m) O.A.L. through 6000 mm (6.0 m) in most configurations
- Temperature Range:
 - EPDM Temperature Range: -40°F (-40°C) to 248°F (120°C)
 - Nylon Temperature Range: -40°F (-40°C) to 248°F (120°C)



U.S. Patent No.
8,819,922
Check www.scrhose.com
for product updates

WARNING

This product can expose you to chemicals including Carbon-black extracts, which is known to the State of California to cause cancer, and Toluene, which is known to the State of California to cause birth defects or other reproductive harm. For more information go to www.P65Warnings.ca.gov.

SCR Hose

Electrically Heated, On-vehicle DEF Dosing System Hose

Series SCR - DEF Transfer Hose

| Core Tube Material | I.D. | | O.D. | | With Heat / Abrasion Shield (optional) | | Maximum Operating Pressure | | Vacuum Resistance | | Bend Radius | |
|--------------------|------|------|------|------|--|------|----------------------------|------|-------------------|-----|-------------|--------|
| | mm | inch | mm | inch | mm | inch | psi | bar | inch/Hg | bar | mm | inch |
| EPDM | 4.0 | .157 | 14.5 | .571 | 21.0 | .827 | 174 | 12.0 | 14.8 | 500 | 30.0 | 1-3/16 |
| | 5.5 | .217 | 14.5 | .571 | 21.0 | .827 | 174 | 12.0 | 14.8 | 500 | 40.0 | 1-9/16 |
| Nylon | 6.0 | .236 | 14.0 | .551 | 21.0 | .827 | 150 | 10.3 | 8.9 | 300 | 40.0 | 1-9/16 |

U.S. Patent No.
8,819,922
Check www.scrhose.com
for product updates



CUSTOM OPTIONS AVAILABLE

SCR options include, but are not limited to:

- different electrical connectors, including options for heat and abrasion shield over lead wires;
- 1/4, 5/16, and 3/8 fittings; wide variety of lengths;
- 12V or 24V

Parflex also has designs for other sizes and core tubes for SCR hoses. These designs ensure that Parflex hoses can be utilized on SCR systems from multiple suppliers.

WARNING

This product can expose you to chemicals including Carbon-black extracts, which is known to the State of California to cause cancer, and Toluene, which is known to the State of California to cause birth defects or other reproductive harm. For more information go to www.P65Warnings.ca.gov.



Fittings

Permanent/Crimp

Field Attachable

General Technical

Tooling, Equipment, & Accessories

Fittings

Transportation

Coiled Air Hose & Fittings

Tubing Thermoplastic

Hose



Table of Contents

INTRODUCTION / TECHNICAL

| | |
|--|------|
| Fitting Configurations..... | E-5 |
| Sanitary Sizing | E-6 |
| Pressure Rating - Fitting End Connections..... | E-8 |
| Hose Fitting Insertion Values | E-10 |
| Identifying Fitting Types | E-11 |
| Determining Thread Type..... | E-12 |
| German DIN Type..... | E-13 |
| British Standard Pipe..... | E-14 |
| North American Thread Types | E-15 |
| Japanese Fittings | E-17 |
| Fitting Thread Guide for Hose..... | E-18 |
| Media to Fitting Compatibility..... | E-20 |
| Metals Corrosion Scale..... | E-21 |

NOMENCLATURE

| | |
|----------------------------|-----|
| Fitting Nomenclature | E-4 |
|----------------------------|-----|

FIELD ATTACHABLE

| | |
|----------------------|------|
| 51 Series | E-22 |
| 51R Series | E-24 |
| 90 Series | E-26 |
| BU Series | E-31 |
| MS Series (FA) | E-32 |

PERMANENT/CRIMP

| | |
|------------------------------|------|
| 56 Series | E-33 |
| Rapid Assembly | E-50 |
| 91/91N Series | E-51 |
| 92 Series | E-61 |
| 93N Series | E-62 |
| 94/95 Series | E-64 |
| PAGE Fittings..... | E-65 |
| CG Series | E-72 |
| CY Series | E-77 |
| MS Series, (permanent) | E-80 |
| SF Series | E-81 |
| SQ Series | E-82 |

A
Hose

B
Tubing
Thermoplastic

C
Coiled Air Hose
& Fittings

D
Transportation

E
Fittings

F
Tooling, Equipment
& Accessories

G
General Technical

Fittings

Nomenclature

Legacy Fitting Nomenclature

Example: 10356-8-6

This example describes a permanent crimp 1/2" Male JIC 37° with a 3/8" I.D. hose size. This fitting is constructed of steel since the designated material is blank.

Order Information

Example: 10356-8-6

10356-8-6 – **Fitting Type** (1 = Permanent/Crimp)
(2 = Field Attachable Fitting)

10356-8-6 – **End Configuration Code - Male JIC 37°**

10356-8-6 – **Fitting Series - 56 Series**

10356-8-6 – **End Size (1/2")**

10356-8-6 – **Hose I.D. (3/8")**

10356-8-6C – **Alternate Material** (C=Stainless Steel)



CG

56

Legacy Fitting Material Selection

- Blank = Steel (unless otherwise noted)
- C = Stainless Steel
- S = Steel (Used only with 91N-series PTFE fittings)

NOTE: Fitting part numbers that start with a "2" are field attachable fittings.

PAGE Fitting Nomenclature

Example: 08-16SAN-S

This example describes a permanent sanitary flange step down, 1/2" I.D. hose with a 1" sanitary flange. This fitting is constructed of stainless steel since the designated material is -S.

As demonstrated below, the nomenclature associated with the PAGE fitting is not consistent with the traditional Parker products, as the end size and hose I.D. are reversed and located at the front of the part construction.



Order Information

Example: 08-16SAN-S

08-16SAN-S – **Hose I.D. (1/2")**

08-16SAN-S – **End Size (1")**

08-16SAN-S – **End Configuration Code - Sanitary Flange**

08-16SAN-S – **Alternate Material** (S =Stainless Steel)

PAGE Fitting Material Selection

- C = Steel
- S = Stainless Steel

NOTE: The PAGE fittings, which are designed for use with traditional PAGE fluoropolymer hoses only, are a two piece crimp connection and need to be combined with the corresponding crimp collars located on page E-48.

Fitting Configurations

by Connection and End Code

| | End Code | Description |
|-----------------|----------------|---|
| Pipe | 01 | Male NPTF Pipe - Rigid - Straight |
| | 13 | Male NPTF Pipe - Swivel - Straight |
| | 1L | Male NPTF Pipe - Swivel - 90° Elbow |
| | 02 | Female NPTF Pipe - Rigid - Straight |
| | 07 | Female NPSM Pipe - Swivel - Straight (60° Cone) |
| SAE Str. Thread | 05 | Male SAE Straight Thread with O-ring - Rigid - Straight |
| | 0G | Male SAE Straight Thread with O-ring - Swivel - Straight |
| | 0L | Male SAE Straight Thread with O-ring - Swivel - 90° Elbow |
| | 35 | Male SAE Straight Thread with O-ring - Adjustable - 90° Elbow |
| | | |
| Flare | 03 | Male JIC 37° - Rigid - Straight |
| | LB | Male JIC 37° - Bulkhead without Locknut - Straight |
| | 06 | Female JIC 37° - Swivel - Straight |
| | 37 | Female JIC 37° - Swivel - 45° Elbow - Short Drop |
| | L7 | Female JIC 37° - Swivel - 45° Elbow - Medium Drop |
| | 39 | Female JIC 37° - Swivel - 90° Elbow - Short Drop |
| | L9 | Female JIC 37° - Swivel - 90° Elbow - Medium Drop |
| | 41 | Female JIC 37° - Swivel - 90° Elbow - Long Drop |
| | 04 | Male SAE 45° - Rigid - Straight |
| | 08 | Female SAE 45° - Swivel - Straight |
| | 77 | Female SAE 45 / Swivel - 45° Elbow |
| | 79 | Female SAE 45 / Swivel - 90° Elbow |
| | 81 | Female SAE 45 / Swivel - 90° Elbow - Long Drop |
| | 06 | Female JIC 37°/SAE 45° Dual Flare - Swivel - Straight |
| | Inverted Flare | 28 |
| 67 | | Male Inverted SAE 45° - Swivel - 45° Elbow |
| 69 | | Male Inverted SAE 45° - Swivel - 90° Elbow |
| 29 | | Female Inverted SAE 45° - Rigid - Straight |
| | | |
| Seal-Lok | J0 | Male Seal-Lok - Rigid - Straight (with O-ring) |
| | JB | Male Seal-Lok - Bulkhead without Locknut-Straight (with O-ring) |
| | JS | Female Seal-Lok - Swivel - Straight - Long |
| | JC | Female Seal-Lok - Swivel - Straight - Short |
| | J2 | Female Seal-Lok - Swivel - 30° Elbow |
| | J6 | Female Seal-Lok - Swivel - 22 1/2° Elbow |
| | J7 | Female Seal-Lok - Swivel - 45° Elbow |
| | J9 | Female Seal-Lok - Swivel - 90° Elbow - Short Drop |
| | J5 | Female Seal-Lok - Swivel - 90° Elbow - Medium Drop |
| | J1 | Female Seal-Lok - Swivel - 90° Elbow - Long Drop |
| JIS | MU | Female Metric Swivel - Straight (30° Flare) |
| | FU | Female BSP Parallel Pipe - Swivel - Straight (30° Flare) |
| | UT | Male BSP Taper Pipe - Rigid - Straight (60° Cone) |
| | GU | Female BSP Parallel Pipe - Swivel - Straight (60° Cone) |
| | G1 | Female BSP Parallel Pipe - Swivel - 45° Elbow (60° Cone) |
| Metric | G2 | Female BSP Parallel Pipe - Swivel - 90° Elbow (60° Cone) |
| | D0 | Male Metric L - Rigid - Straight (24° Cone) |
| | 1D | Male Standpipe Metric L - Rigid - Straight |

| | Description | End Code | |
|--|---|---|----|
| Metric | Female Metric L - Swivel - Straight (Ball Nose) | C3 | |
| | Female Metric L - Swivel - 45° Elbow (Ball Nose) | C4 | |
| | Female Metric L - Swivel - 90° Elbow (Ball Nose) | C5 | |
| | Female Metric L - Swivel - Straight (24° Cone with O-ring) | CA | |
| | Female Metric L - Swivel - 45° Elbow (24° Cone with O-ring) | CE | |
| | Female Metric L - Swivel - 90° Elbow (24° Cone with O-ring) - | CF | |
| | Male Metric S - Rigid - Straight (24° Cone) | D2 | |
| | Male Standpipe Metric S - Rigid - Straight | 3D | |
| | Female Metric S - Swivel - Straight (Ball Nose) | C6 | |
| | Female Metric S - Swivel - 45° Elbow (Ball Nose) | C7 | |
| | Female Metric S - Swivel - 90° Elbow (Ball Nose) | C8 | |
| | Female Metric S - Swivel - Straight (24° Cone with O-ring) | C9 | |
| | Female Metric S - Swivel - 45° Elbow (24° Cone with O-ring) | 0C | |
| | Female Metric S - Swivel - 90° Elbow (24° Cone with O-ring) | 1C | |
| | BSP | Male BSP Taper Pipe - Rigid - Straight | 91 |
| Female BSP Parallel Pipe - Swivel - Straight (60° Cone) | | 92 | |
| Male BSP Parallel Pipe - Rigid - Straight (60° Cone) | | D9 | |
| Female BSP Parallel Pipe - Swivel - 45° Elbow (60° Cone) | | B1 | |
| Female BSP Parallel Pipe - Swivel - 90° Elbow (60° Cone) | | B2 | |
| Female BSP Parallel Pipe - Swivel - Straight (Flat Seat) | | B5 | |
| Male BSP Taper Pipe - Rigid - 45° Elbow | | BV | |
| Male BSP Taper Pipe - Rigid - 90° Elbow or Side Outlet | | BZ | |
| Specialty | | Male Ferulok Flareless Rigid-Straight (24° Cone with Nut & Ferrule) | 11 |
| | | Female Ferulok Flareless - Swivel - Straight (24° Cone) | 12 |
| | DIN Metric Banjo - Straight | 49 | |
| | ANSI B16.5 Flange | 4K | |
| | Female A-Lok® Compression | AL | |
| | Female Cam & Groove | FC | |
| | Sanitary Flange & Step Downs | FN | |
| | Mini Sanitary Flange | FV | |
| | Bulkhead w/Zerk Port Integrated | GK | |
| | Male I-Line® Sanitary | H1 | |
| | Female I-Line® Sanitary | H2 | |
| | Male Sanitary Bevel Seat | H4 | |
| | Female Sanitary Bevel Seat | H5 | |
| | Male Standpipe - Rigid - Straight (Inch Size Tube O.D.) | 34 | |
| | Male Standpipe - Rigid - Straight with V-Notch | TW | |
| Universal Tube Stub | TU | | |
| Male Rapid Assembly, Straight | WU | | |
| Male Rapid Assembly, 45° Elbow | WW | | |
| Male Rapid Assembly, 90° Elbow | WY | | |

A Hose

B Tubing Thermoplastic

C Coiled Air Hose & Fittings

D Transportation

E Fittings

F Tooling, Equipment & Accessories

G General Technical

Sanitary Sizing (PAGE Series)

Typical Dimensions

These actual size drawings are provided to eliminate sizing errors when specifying sanitary fittings. The outside diameter is the same for 1/8", 1/4", 3/8", 1/2" and the 3/4" (mini) styles. For your convenience and ordering accuracy, all of these drawings may be used as sizing I.D. and O.D. patterns. These fittings are ASME-BPE compliant.

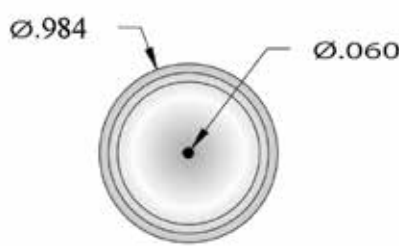

1/8" MINI T.C.

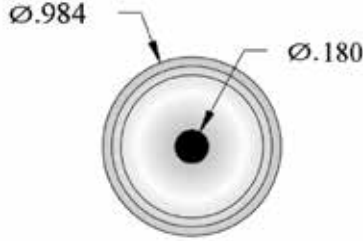

1/4" MINI T.C.

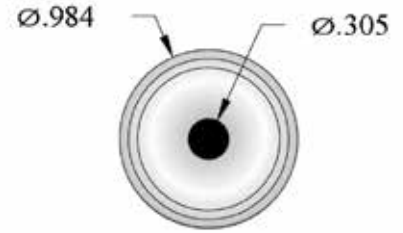

3/8" MINI T.C.

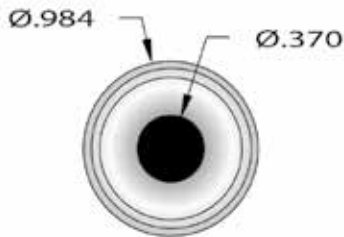

1/2" MINI T.C.

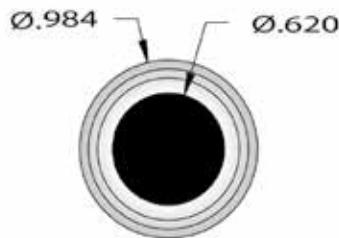

3/4" MINI T.C.

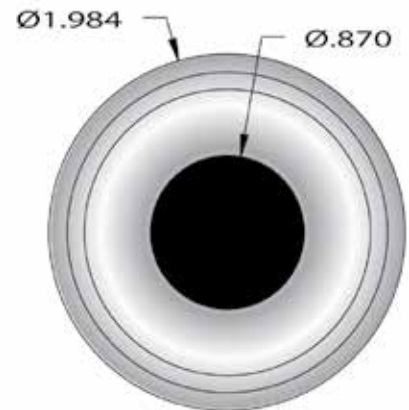

1" T.C.

(Cont.)

Sanitary Sizing (PAGE Series)

Typical Dimensions

These actual size drawings are provided to eliminate sizing errors when specifying sanitary fittings. The outside diameter is the same for 1/8", 1/4", 3/8", 1/2" and the 3/4" (mini) styles. For your convenience and ordering accuracy, all of these drawings may be used as sizing I.D. and O.D. patterns. These fittings are ASME-BPE compliant.

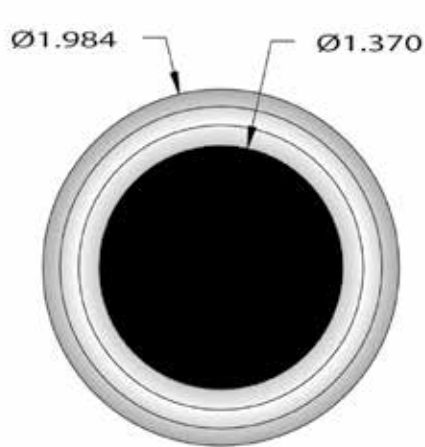

1 1/2" T.C.

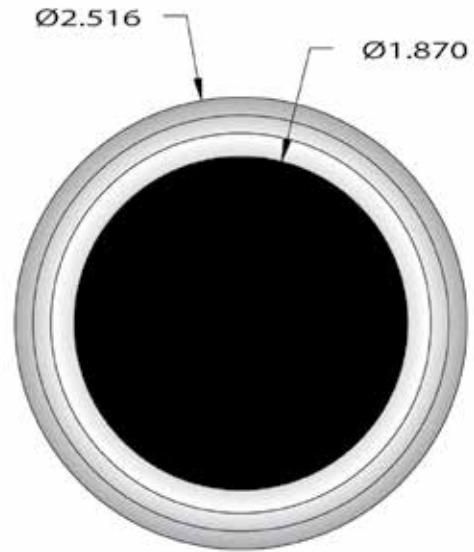

2" T.C.

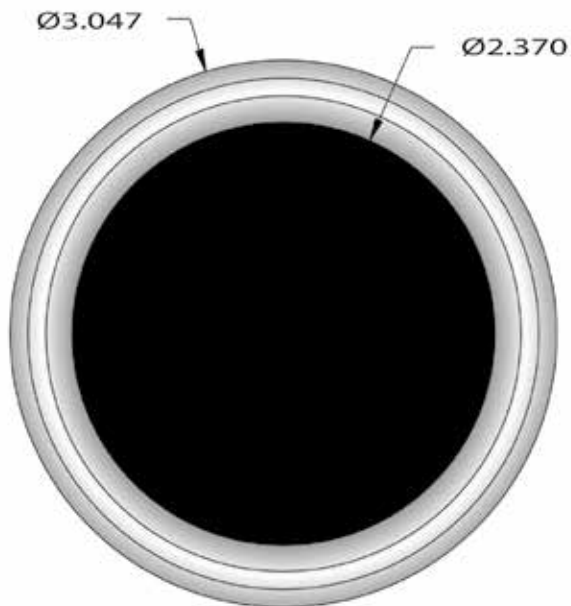

2 1/2" T.C.

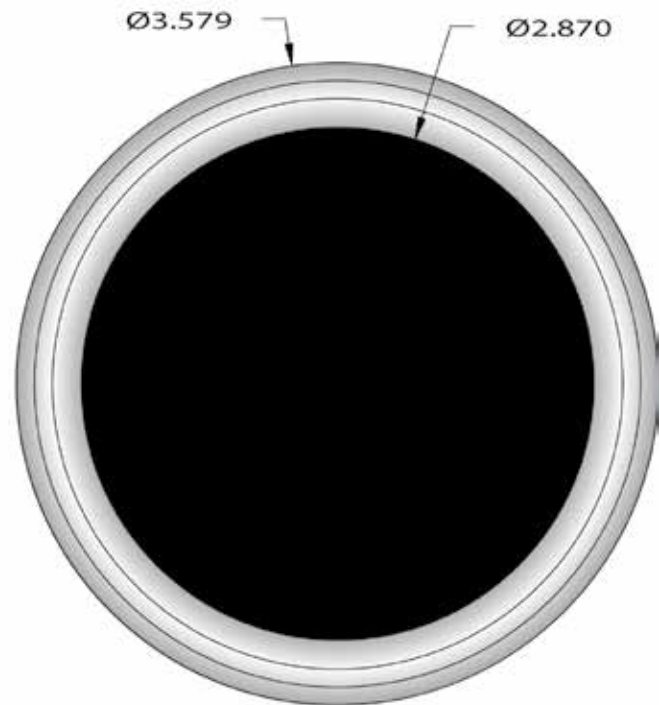

3" T.C.

Hose
A

Tubing
Thermoplastic
B

Coiled Air Hose
& Fittings
C

Transportation
D

Fittings
E

Tooling, Equipment
& Accessories
F

General Technical
G

Pressure Rating of Fitting End Connections

Inch Fittings

| Fitting End Connection | Part Number | Inch Fittings | | | | | | | | | | | | | | | | | | | | | | | | | | | | |
|--|---|--|---------------|--------------|--------------|---------------|---------------|--------------|--------------|--------------|--------------|--------------|--------------|--------------|--------------|--------------|--------------|--------------|--------------|-----------|-----------|-----------|-----------|--------------|--------------|-----------|-----------|-----------|--|--|
| | | -2 | | -4 | | -5 | | -6 | | -8 | | -10 | | -12 | | -16 | | -20 | | -24 | | -32 | | -40 | | -48 | | -64 | | |
| | | psi (MPa) | psi (MPa) | psi (MPa) | psi (MPa) | psi (MPa) | psi (MPa) | psi (MPa) | psi (MPa) | psi (MPa) | psi (MPa) | psi (MPa) | psi (MPa) | psi (MPa) | psi (MPa) | psi (MPa) | psi (MPa) | psi (MPa) | psi (MPa) | psi (MPa) | psi (MPa) | psi (MPa) | psi (MPa) | psi (MPa) | psi (MPa) | psi (MPa) | psi (MPa) | psi (MPa) | | |
| Male Pipe (NPTF) | 01 & MP | 12,000 (82.7) | 12,000 (82.7) | | | 10,000 (68.9) | 10,000 (68.9) | | | | | 7,500 (51.7) | 6,500 (44.8) | 5,000 (34.5) | 3,000 (20.7) | 2,500 (17.2) | 200 (1.4) | 175 (1.2) | 150 (1.0) | | | | | | | | | | | |
| Female Pipe (NPTF, NPSM) | 02,07 & FP | 7,500 (51.7) | 7,000 (48.3) | | | 6,000 (41.4) | 5,000 (34.5) | | | | | 4,000 (27.6) | 3,000 (20.7) | 2,500 (17.2) | 2,000 (13.8) | 2,000 (13.8) | | | | | | | | | | | | | | |
| Male Pipe (BSP) | 91 & D9 | 5,000 (34.5) | 9,000 (62.1) | | | 8,000 (55.2) | 6,250 (43.1) | | | | | 5,000 (34.5) | 4,000 (27.6) | 3,500 (24.1) | 3,000 (20.7) | 3,000 (20.7) | | | | | | | | | | | | | | |
| Female Pipe (BSP) | 92, B1, B2 & B4 | 5,000 (34.5) | 9,000 (62.1) | | | 8,000 (55.2) | 6,250 (43.1) | 5,500 (37.9) | 5,000 (34.5) | | | 4,000 (27.6) | 3,500 (24.1) | 3,000 (20.7) | 3,000 (20.7) | | | | | | | | | | | | | | | |
| Female Pipe (JIS) | FU, GU, MU & UT | | 5,000 (34.5) | | | 5,000 (34.5) | 5,000 (34.5) | | | | | 4,000 (27.6) | 3,000 (20.7) | 2,500 (17.2) | 1,500 (10.3) | 1,500 (10.3) | | | | | | | | | | | | | | |
| O-Ring Swivel and 45° Flare | 04, 13, 1L, S2, 0G, 0L, 48, 08, 77 & 79 | | 3,000 (20.7) | 3,000 (20.7) | 3,000 (20.7) | 3,000 (20.7) | 3,000 (20.7) | 2,750 (19.0) | 2,250 (15.5) | 2,000 (13.8) | 1,625 (11.2) | 1,250 (8.6) | 1,125 (7.8) | | | | | | | | | | | | | | | | | |
| 37° Flare & Straight* (2) Thread O-Ring Boss | 03, 05, 06, FJX, 37, 39, 41, L7 & L9 | | 6,000 (41.4) | 6,000 (41.4) | 5,000 (34.5) | 5,000 (34.5) | 5,000 (34.5) | 5,000 (34.5) | 5,000 (34.5) | 4,000 (27.6) | 3,000 (20.7) | 2,500 (17.2) | 2,500 (17.2) | 200 (1.4) | | | | | | | | | | | | | | | | |
| Cam & Groove | E, CL | | | | | | | | | | 250 (1.7) | 250 (1.7) | 250 (1.7) | 250 (1.7) | | | | | | | | | | 175 (1.2) | 150 (1.0) | | | | | |
| SAE Flareless | 11 & 12 | | 6,000 (41.4) | 6,000 (41.4) | 5,600 (38.6) | 5,600 (38.6) | 4,200 (29.0) | 4,200 (29.0) | 3,500 (24.1) | 3,500 (24.1) | 3,000 (20.7) | 3,000 (20.7) | 3,000 (20.7) | 3,000 (20.7) | | | | | | | | | | 3,000 (20.7) | 3,000 (20.7) | | | | | |
| SAE Inverted Flare | 28, 67 & 69 | | 2,750 (19.0) | 2,500 (17.2) | 2,250 (15.5) | 2,000 (13.8) | | | | | | | | | | | | | | | | | | | | | | | | |
| Seal-Lok® (O-Ring Face Seal) | JM, JC, JS, FORFS, J0, J1, J5, J7 & J9 | | 6,000 (41.4) | | 6,000 (41.4) | 6,000 (41.4) | 6,000 (41.4) | 6,000 (41.4) | 6,000 (41.4) | 6,000 (41.4) | 4,000 (27.6) | 4,000 (27.6) | | | 4,000 (27.6) | 4,000 (27.6) | | | | | | | | 4,000 (27.6) | 4,000 (27.6) | | | | | |
| A-Lok® | TU, AL, PLCF & TUBE | | 6,000 (41.4) | 6,000 (41.4) | 5,600 (38.6) | 5,600 (38.6) | 4,200 (29.0) | 4,200 (29.0) | 3,500 (24.1) | 3,500 (24.1) | 3,000 (20.7) | 3,000 (20.7) | 3,500 (24.1) | 3,000 (20.7) | 3,000 (20.7) | 3,000 (20.7) | 3,500 (24.1) | 3,000 (20.7) | 3,000 (20.7) | | | | | | | | | | | |
| Rapid Assembly* (1) | WU, WY, WW | | 3,000 (20.7) | | 3,000 (20.7) | | | | | | | | | | | | | | | | | | | | | | | | | |
| Sanitary Bevel Seat | FBS, MBS | | | | | | | | | 400 (2.8) | 400 (2.8) | 400 (2.8) | 400 (2.8) | 400 (2.8) | 400 (2.8) | 200 (1.4) | 175 (1.2) | 150 (1.0) | | | | | | | | | | | | |
| ANSI B16.5 150# Flange (to 100°F) | PF, SFR | | | | | | 285 (2.0) | | 285 (2.0) | 285 (2.0) | 285 (2.0) | 285 (2.0) | 285 (2.0) | 285 (2.0) | 200 (1.4) | 175 (1.2) | 150 (1.0) | | | | | | | | | | | | | |
| I-Line® Sanitary | FIL, MIL, MSAN, SAN | Consult Manufacturer of Seals and Clamps for Ratings | | | | | | | | | | | | | | | | | | | | | | | | | | | | |
| Grease Zerk | NA-6520 (GK) | Meets SAE J534:2015 requirements with 5,000 psi (34.5 MPa) blowout protection. | | | | | | | | | | | | | | | | | | | | | | | | | | | | |

* (1) Rapid Assembly connection has a temperature range of -40°F (-40°C) to 212°F (100°C)

* (2) .When used with 527BA hose only, Parflex -4 JIC and -4 O-ring boss fittings are rated for 7000 psi (48.3 MPa) working pressure

NOTES:

- All the above ratings are based on steel and stainless steel hose Parflex fittings.
- Parflex 106CG-16-16 / 106CG-16-16C is rated for 5000 psi (34.5 Mpa) working pressure.
- Fitting connections such as I-Line®, ANSI B16.5 Flange, Sanitary Bevel Seat, Cam and Groove, Seal-Lok® require elastomeric seals to function properly. When specifying or replacing seals, ensure the selected seal type meets the performance requirements of the application, including temperature, pressure, chemical compatibility and permeability.
- The maximum working pressure of a tube or hose assembly is the lower of the respective published maximum working pressures of the hose, tube and the fittings used.
- The maximum working pressures of hoses are listed on Page A-10 : A-17 with each hose description in Section A.

Pressure Rating of Fitting End Connections

Metric Fittings

| Fitting End Connection | Part Number | Metric Fittings | | | | | | | | | | | | | | | | | | | | | | | | | | | | | | | |
|-------------------------------------|-----------------|-----------------|--------------|--------------|--------------|--------------|-----------|--------------|--------------|-----------|--------------|--------------|-----------|--------------|--------------|-----------|--------------|--------------|-----------|--------------|--------------|-----------|--------------|-----------|-----------|-----------|-----------|-----------|--------------|--------------|-------------|-----|--|
| | | -6 | | -8 | | -10 | | -12 | | -14 | | -15 | | -16 | | -18 | | -20 | | -22 | | -25 | | -28 | | -30 | | -35 | | -38 | | -42 | |
| | | psi (MPa) | psi (MPa) | psi (MPa) | psi (MPa) | psi (MPa) | psi (MPa) | psi (MPa) | psi (MPa) | psi (MPa) | psi (MPa) | psi (MPa) | psi (MPa) | psi (MPa) | psi (MPa) | psi (MPa) | psi (MPa) | psi (MPa) | psi (MPa) | psi (MPa) | psi (MPa) | psi (MPa) | psi (MPa) | psi (MPa) | psi (MPa) | psi (MPa) | psi (MPa) | psi (MPa) | psi (MPa) | psi (MPa) | psi (MPa) | | |
| DIN Light "L" without O-Ring | C3, C4, C5 & 1D | 3,500 (24.1) | 3,500 (24.1) | 3,500 (24.1) | 3,500 (24.1) | | | 3,500 (24.1) | | | 2,250 (15.5) | | | 2,250 (15.5) | | | 1,400 (9.7) | | | 1,400 (9.7) | | | 1,400 (9.7) | | | | | | | | 1,400 (9.7) | | |
| DIN Light "L" with O-Ring | D0, CA, CE & CF | 4,500 (31.0) | 4,500 (31.0) | 4,500 (31.0) | 4,500 (31.0) | | | 4,500 (31.0) | | | 2,250 (15.5) | | | 2,250 (15.5) | | | 2,250 (15.5) | | | 2,250 (15.5) | | | 2,250 (15.5) | | | | | | | 2,250 (15.5) | | | |
| DIN Heavy "S" without O-Ring | C6, C7, C8 & 3D | | 9,000 (62.1) | 9,000 (62.1) | 9,000 (62.1) | 9,000 (62.1) | | | 5,750 (39.6) | | | 5,750 (39.6) | | | 5,750 (39.6) | | | 3,500 (24.1) | | | 3,500 (24.1) | | | | | | | | 3,500 (24.1) | | | | |
| DIN Heavy "S" with O-Ring | C9, 0C, 1C & D2 | | 9,000 (62.1) | 9,000 (62.1) | 9,000 (62.1) | 9,000 (62.1) | | | 6,000 (41.4) | | | 6,000 (41.4) | | | 6,000 (41.4) | | | 6,000 (41.4) | | | 6,000 (41.4) | | | | | | | | 4,500 (31.0) | | | | |

NOTES:

- All the above ratings are based on steel and stainless steel hose Parflex fittings.
- Parflex 106CG-16-16 / 106CG-16-16C is rated for 5000 psi (34.5 Mpa) working pressure.
- Fitting connections such as I-Line®, ANSI B16.5 Flange, Sanitary Bevel Seat, Cam and Groove, Seal-Lok® require elastomeric seals to function properly. When specifying or replacing seals, ensure the selected seal type meets the performance requirements of the application, including temperature, pressure, chemical compatibility and permeability.
- The maximum working pressure of a tube or hose assembly is the lower of the respective published maximum working pressures of the hose, tube and the fittings used.
- The maximum working pressures of hoses are listed on Page A-10 : A-17 with each hose description in Section A.

A Hose

B Tubing Thermoplastic

C Coiled Air Hose & Fittings

D Transportation

E Fittings

F Tooling, Equipment & Accessories

G General Technical

Hose Fitting Insertion Values

Inch & Metric

A Hose

Inch

| Hose Dash Size | 51 | 51R | 54 | 56 | CG | 90 | 91/91N | 92 | 93N | BU | CY | MS Field Attachable | MS Permanent |
|----------------|---------|--------|-------|-------|--------|-------|--------|------|-------|-------|-------|---------------------|--------------|
| -2 | | | | 5/8 | | | | | | 1/2 | 1/2 | | |
| -3 | 13/16 | 1-7/16 | 5/8 | 5/8 | 29/32 | | 7/16 | 9/16 | | 13/16 | 13/16 | | |
| -4 | 15/16 | 1-1/2 | 3/4 | 15/16 | 1-3/16 | 7/16 | 1/2 | | | | | | |
| -5 | 15/16 | | 7/8 | 1 | | 9/16 | 9/16 | | | | | 11/16 | 11/16 |
| -6 | 1-5/16 | 1-5/8 | 15/16 | 1 | 1-5/16 | 9/16 | 5/8 | | 7/16 | | | 15/16 | 3/4 |
| -8 | 1-19/32 | 1-3/4 | 15/16 | 1-1/8 | 1-9/16 | 5/8 | 11/16 | | 7/16 | | | | |
| -10 | | | | 1-1/8 | | 11/16 | 11/16 | | 3/4 | | | | |
| -12 | 1-13/16 | | | 1-3/8 | 2-3/16 | 11/16 | 3/4 | | 7/8 | | | | |
| -16 | 1-9/16 | | | 1-7/8 | 2-3/4 | 11/16 | 15/16 | | 15/16 | | | | |
| -20 | | | | | | 11/16 | 1 | | 1 | | | | |
| -24 | | | | | | | | | 1-1/8 | | | | |
| -24 | | | | | | | | | 1-3/8 | | | | |

Metric

| Hose Dash Size | 51 | 51R | 54 | 56 | CG | 90 | 91/91N | 92 | 93N | BU | CY | MS Field Attachable | MS Permanent |
|----------------|----|-----|----|----|----|----|--------|----|-----|----|----|---------------------|--------------|
| -2 | | | | 16 | | | | | | 13 | 13 | | |
| -3 | 21 | 36 | 16 | 16 | 23 | | 11 | 14 | | 21 | 21 | | |
| -4 | 24 | 38 | 19 | 24 | 30 | 11 | 13 | | | | | | |
| -5 | 24 | | 22 | 25 | | 14 | 14 | | | | | 17 | 17 |
| -6 | 33 | 41 | 24 | 25 | 33 | 14 | 16 | | 11 | | | 24 | 19 |
| -8 | 40 | 44 | 24 | 29 | 40 | 16 | 17 | | 11 | | | | |
| -10 | | | | 29 | | 17 | 17 | | 19 | | | | |
| -12 | 46 | | | 35 | 56 | 17 | 19 | | 22 | | | | |
| -16 | 40 | | | 48 | 70 | 17 | 24 | | 24 | | | | |
| -20 | | | | | | 17 | 25 | | 25 | | | | |
| -24 | | | | | | | | | 29 | | | | |
| -32 | | | | | | | | | 35 | | | | |

B Tubing Thermoplastic

C Coiled Air Hose & Fittings

D Transportation

E Fittings

F Tooling, Equipment, & Accessories

G General Technical

Identifying Fitting Types

Sealing and Thread Identification

In general fittings can be identified by their visual appearance, their sealing surface/sealing type or by their thread type/form. Viewing the following pages, the visual identification will be self explanatory. The sealing mechanism and the method of thread identification, however, needs further explanation.

Determining Sealing Mechanisms

- Thread interface
- O-ring
- Matching angle or metal-to-metal joint
- Mated angle with O-ring

Thread Interface

The sealing is assured by the flattening of the edges of the threads when the male is screwed into the female fitting. Typically the front of the male fittings is narrower than the back of the fittings – often referred to as tapered threads.

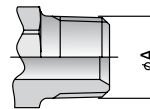

O-ring

The O-ring on the male is compressed against the corresponding female and assures the seal. This type of sealing mechanism should be the preferred choice for high-pressure applications.

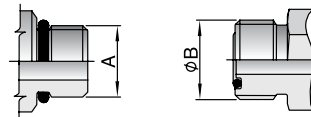

Matching Angle or Metal-to-Metal Joint

Sealing takes place where the two angled faces of the male and corresponding female meet and are wedged into one another by the tightening of the threaded nut. The sealing surfaces can either be convex or concave (seat) on the male or in the head of the pipe of the female as shown.

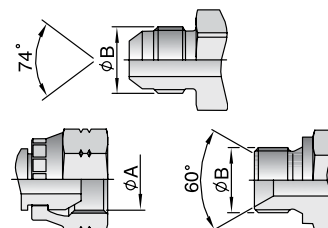

Matching Angle with O-ring

These fittings combine the functionality of both the matching angle seal with the O-ring. The O-ring is in the angled sealing surface of the fitting so that when the threaded male and female are screwed together the sealing surfaces wedge together and at the same time deform the O-ring between them.

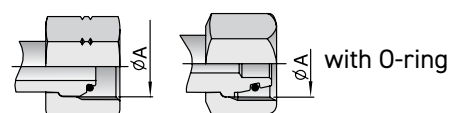

Determining Thread Type

Identifying Type

In general, the threads of various fittings look similar and hinder the easy identification of the thread. To assure the correct identification, the threads must be measured and compared to the tables listed in the following section.

Thread Gauge

Using a thread gauge, the number of threads per inch can be determined. Holding the gauge and coupling threads in front of a lighted background helps to obtain an accurate measurement.

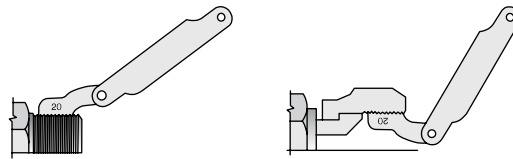

Caliper Measure

A vernier caliper should be used to measure the thread diameter of the largest point. (Outside diameter (O.D.) of male threads
Inside Diameter (I.D.) of female threads.)

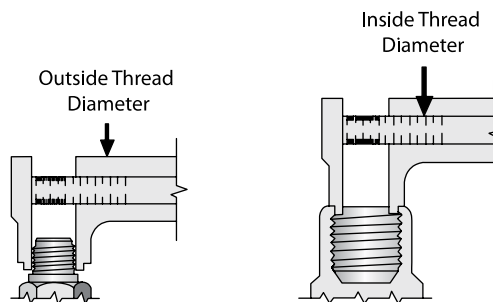

German DIN Hose Fittings

Metric Fittings

Often referred to as metric fittings, these fittings seal using the angled sealing surfaces (metal-to-metal) or the combination of metal-to-metal with O-rings.

They are available in light (L) or heavy series (S).

The sealing face angles are either 24° with or without O-rings, or 24°/60° universal cones.

Identification is made by measuring the thread size and also the tube outside diameter.

Defined by the outside diameter and the pitch (distance between 2 crests of the thread)
example: M22x1.5 - pitch of 1.5mm.

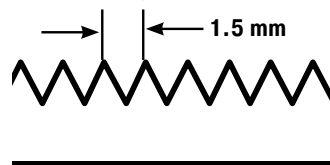

DIN Light (L) and Heavy Series (S) without O-ring

The male 24° cone will mate with the female universal 24° or 60° cone only. The male has a 60° sealing angle (seat) and straight metric threads. The female has a 24° and 60° universal seat and straight metric threads.

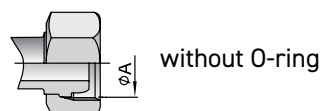

Standard

DIN 20078 Part 2¹⁾
(previously known as DIN 20078 A, D & E)

Parker end configurations light series
C3, C4, C5, C6

(Often referred to as "Ball nose cones") 1) obsolete standard, no exact replacement

DIN 24° Light (L) and Heavy Series (S) with O-ring

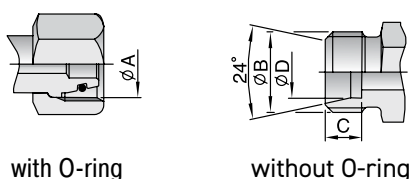

The male has a 24° sealing angle cone seat with straight metric threads.

The female has a 24° convex cone with O-ring and a swivel straight metric threaded nut.

Standard

ISO 12151-2 / ISO 8434-1 & ISO 8434-4
(Previously DIN 20 078 Part 4, 5, 8, 9)

Parker end configurations light series
CA, CE, CF, D0

Parker end configurations heavy series
C9, 0C, 1C, D2

| Tube O.D. DN | Spec | Thread metric | ØA mm | ØB mm | C mm | ØD mm |
|-----------------|------|------------------|----------|----------|---------|----------|
| 6.00 | 6L | M12X1.5 | 10.50 | 12.00 | 7.00 | 6.20 |
| 6.00 | 6S | M14X1.5 | 12.50 | 14.00 | 7.00 | 6.20 |
| 8.00 | 8L | M14x1.5 | 12.50 | 14.00 | 7.00 | 8.20 |
| 8.00 | 8S | M16x1.5 | 14.50 | 16.00 | 7.00 | 8.20 |
| 10.00 | 10L | M16x1.5 | 14.50 | 16.00 | 7.00 | 10.20 |
| 10.00 | 10S | M18x1.5 | 16.50 | 18.00 | 7.50 | 10.20 |
| 12.00 | 12L | M18x1.5 | 16.50 | 18.00 | 7.00 | 12.20 |
| 12.00 | 12S | M20x1.5 | 18.50 | 20.00 | 7.50 | 12.20 |
| 14.00 | 14S | M22x1.5 | 20.50 | 22.00 | 8.00 | 14.20 |
| 15.00 | 15L | M22x1.5 | 20.50 | 22.00 | 7.00 | 15.20 |
| 16.00 | 16S | M24x1.5 | 22.50 | 24.00 | 8.50 | 16.20 |
| 18.00 | 18L | M26x1.5 | 24.50 | 26.00 | 7.50 | 18.20 |
| 20.00 | 20S | M30x2 | 27.90 | 30.00 | 10.50 | 20.20 |
| 22.00 | 22L | M30x2 | 27.90 | 30.00 | 7.50 | 22.20 |
| 25.00 | 25S | M36x2 | 33.90 | 36.00 | 12.00 | 25.20 |
| 28.00 | 28L | M36x2 | 33.90 | 36.00 | 7.50 | 28.20 |
| 30.00 | 30S | M42x2 | 39.90 | 42.00 | 13.50 | 30.20 |
| 35.00 | 35L | M45x2 | 42.90 | 45.00 | 10.50 | 35.30 |
| 38.00 | 38S | M52x2 | 49.90 | 52.00 | 16.00 | 38.30 |
| 42.00 | 42L | M52x2 | 49.90 | 52.00 | 11.00 | 42.30 |

British Standard Pipe BSP

Also referred to as Whitworth threads, the BSP thread type fittings seal use metal-to-metal angled surfaces or a combination of metal-to-metal and an O-ring. The angle of the sealing surfaces is 60° for both forms.

There are two popular thread forms:

British Standard Pipe Parallel (BSPP) and British Standard Pipe Tapered (BSPT).

Identification is made by measuring the outside diameter of the thread and the number of threads per inch (25.4 mm)

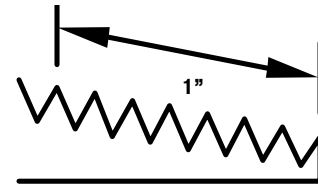

BSPP

BS5200

Parker end configurations 92, B1, B2, B4, D9

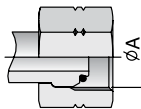
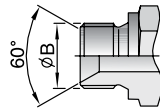
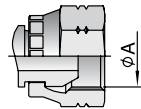

BSPP

metal-to-metal with O-ring

Standard ISO 12151-6

Some Parker end configurations may be non-standard parts.

BSPT

BS5200

Fittings seal through the thread interface mechanism. Care should be taken not to confuse the BSPT fitting with the NPTF male fitting. BSPT has a 55° thread angle.

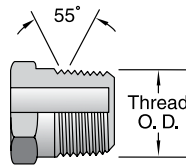

NPTF has 60° thread angle. Parker end configurations 91

BSP Flat Seal

These fittings have BSP parallel threads but the sealing surface is flat. The seal is made when the composite seal is compressed against the female flat face. Some Parker end configurations may be non-standard parts.

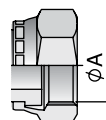

| Tube I.D./O.D. inch | Size | Thread BSP | ØB mm | ØA mm |
|---------------------|------|------------|-------|-------|
| 5/10 | -2 | 1/8x28 | 8.60 | 9.70 |
| 8/13 | -4 | 1/4x19 | 11.50 | 13.20 |
| 12/17 | -6 | 3/8x19 | 14.90 | 16.70 |
| 15/21 | -8 | 1/2x14 | 18.60 | 20.90 |
| 18/23 | -10 | 5/8x14 | 20.60 | 22.90 |
| 20/27 | -12 | 3/4x14 | 24.10 | 26.40 |
| 26/34 | -16 | 1x11 | 30.30 | 33.20 |
| 33/42 | -20 | 1-1/4x11 | 38.90 | 41.90 |
| 40/49 | -24 | 1-1/2x11 | 44.90 | 47.80 |
| 50/60 | -32 | 2x11 | 56.70 | 59.60 |

| Tube I.D./O.D. inch | Size | Thread BSP | ØA mm |
|---------------------|------|------------|-------|
| 5/10 | -2 | 1/8x28 | 9.73 |
| 8/13 | -4 | 1/4x19 | 13.16 |
| 12/17 | -6 | 3/8x19 | 16.66 |
| 15/21 | -8 | 1/2x14 | 20.96 |
| 20/27 | -12 | 3/4x14 | 26.44 |
| 26/34 | -16 | 1x11 | 33.25 |
| 33/42 | -20 | 1-1/4x11 | 41.91 |
| 40/49 | -24 | 1-1/2x11 | 47.80 |
| 50/60 | -32 | 2x11 | 59.61 |

| Tube I.D./O.D. inch | Size | Thread BSP | ØA mm |
|---------------------|------|------------|-------|
| 6/10 | -2 | 1/8x28 | 8.6 |
| 8/13 | -4 | 1/4x19 | 11.5 |
| 12/17 | -6 | 3/8x19 | 14.9 |
| 15/21 | -8 | 1/2x14 | 18.6 |
| 18/23 | -10 | 5/8x14 | 20.6 |
| 20/27 | -12 | 3/4x14 | 24.1 |
| 26/34 | -16 | 1x11 | 30.3 |

North American Thread Types

NPTF

This type of fitting uses the thread interface to seal and as such has a tapered thread that deforms and forms the seal. They have 30° sealing angle surfaces, forming a 60° inverted (concave) seat. The fittings are most frequently seen on machines of US origin.

Dryseal American Standard Taper Pipe Thread (NPTF)

The NPTF male will mate with the NPTF, NPSF, or NPSM females.

Care should be taken not to confuse the NPTF fitting with the BSPT male fitting. NPTF fittings have a 60° thread angle. BSPT has a 55° thread angle.

Standard
SAE J516
Parker end configurations O1

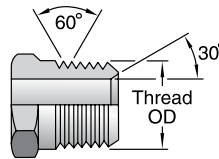

ØA dimension is measured on the pitch of the thread

| Size | Thread NPTF | ØA mm | ØB mm |
|------|----------------|----------|----------|
| -2 | 1/8x27 | 10.24 | 8.73 |
| -4 | 1/4x18 | 13.61 | 11.90 |
| -6 | 3/8x18 | 17.05 | 15.90 |
| -8 | 1/2x14 | 21.22 | 19.05 |
| -12 | 3/4x14 | 26.56 | 24.60 |
| -16 | 1x11.5 | 33.22 | 30.95 |
| -20 | 1-1/4x11.5 | 41.98 | 39.69 |
| -24 | 1-1/2x11.5 | 48.05 | 45.24 |
| -32 | 2x11.5 | 60.09 | 57.15 |

SAE JIC 37°

Commonly referred to as JIC fittings, these metal-to-metal sealing type fittings have a 37° flare (sealing surface angle) and straight United National Fine Threads (UNF).

The original design specification for the fittings comes from the Society of Automotive Engineers (SAE) and these fittings are the most common American fitting types in Europe.

Standard
ISO 12151-5, ISO8434-2 and SAE J516

Parker JIC hose fittings are fully compatible with Parker Triple-Lok Tube Fittings and adapters.

Parker end configurations
03, 06, 37, 39, 41, L9

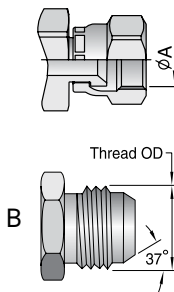

| Tube I.D. inch | Tube O.D. mm | Thread UNF | Size | ØA mm | ØB mm |
|-------------------|-----------------|---------------|------|----------|----------|
| 3/16 | | 3/8x24 | -3 | 8.60 | 9.50 |
| 1/4 | 6 | 7/16x20 | -4 | 10.00 | 11.10 |
| 5/16 | 8 | 1/2x20 | -5 | 11.60 | 12.70 |
| 3/8 | 10 | 9/16x18 | -6 | 13.00 | 14.30 |
| 1/2 | 12 | 3/4x16 | -8 | 17.60 | 19.10 |
| 5/8 | 14-15-16 | 7/8x14 | -10 | 20.50 | 22.20 |
| 3/4 | 18-20 | 1-1/16x12 | -12 | 24.60 | 27.00 |
| 7/8 | 22 | 1-3/16x12 | -14 | 28.30 | 30.10 |
| 1 | 25 | 1-5/16x12 | -16 | 31.30 | 33.30 |
| 1-1/4 | 30-32 | 1-5/8x12 | -20 | 39.20 | 41.30 |
| 1-1/2 | 38 | 1-7/8x12 | -24 | 45.60 | 47.60 |
| 2 | | 2-1/2x12 | x32 | 61.50 | 63.50 |

(Cont.)

North American Thread Types

A Hose

SAE 45° Flare

The angle of the flare is commonly used as a name when referring to these metal-to-metal sealing fittings.

The female fittings have a 90° concave inverted seat, created by the 45° angle sealing surfaces.

The SAE 45° flare male will mate with an SAE 45° flare female only or a dual seat JIC 37°/SAE45°.

Standard
SAE J516

Parker end configurations
04, 08, 77, 79, 81

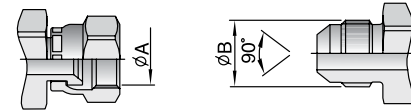

| Tube I.D inch | Size | Thread UNF | Size | ØA mm | ØB mm |
|------------------|------|---------------|-------|----------|----------|
| 1/4 | x4 | 7/16x20 | 9.90 | 11.10 | 9.50 |
| 5/16 | -5 | 1/2x20 | 11.50 | 12.70 | 11.10 |
| 3/8 | -6 | 5/8x18 | 14.30 | 15.90 | 12.70 |
| 1/2 | -8 | 3/4x16 | 17.50 | 19.10 | 14.30 |
| 5/8 | -10 | 7/8x14 | 20.60 | 22.20 | 19.10 |
| 3/4 | -12 | 1-1/16x14 | 25.00 | 27.00 | 22.20 |

B Tubing Thermoplastic

C Coiled Air Hose & Fittings

SAE O-ring (Boss Type)

This male fitting has straight threads, a sealing face and an O-ring. It is compatible only with female boss type fittings generally found in the ports of machines. Sealing is achieved through the O-ring of the male and through the sealing face of the female.

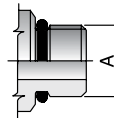

Parker end configurations
05

| Thread UNF | Size | ØA mm | Thread UNF | Size | ØA mm |
|---------------|------|----------|---------------|------|----------|
| 5/16x24 | -2 | 7.93 | 1-1/16x12 | -12 | 27.00 |
| 3/8x24 | -3 | 9.52 | 1-3/16x12 | -14 | 30.10 |
| 7/16x20 | -4 | 11.11 | 1-5/16x12 | -16 | 33.30 |
| 1/2x20 | -5 | 12.70 | 1-5/8x12 | -20 | 41.30 |
| 9/16x18 | -6 | 14.28 | 1-7/8x12 | -24 | 47.60 |
| 3/4x16 | -8 | 19.10 | 2-1/2x12 | -32 | 63.50 |
| 7/8x14 | -10 | 22.22 | | | |

D Transportation

F Fittings

O-ring Face Seal (ORFS)

ORFS fittings are becoming the most popular international fitting type used on global OEM machines due to their high level of sealing and their good vibration resistance. The fittings use the O-ring compression mechanism to seal.

The female fittings have flat faces and straight threaded UNF swivel nuts. The male fittings have the O-ring in a groove in the flat face.

Seen as a major advantage, these fittings offer the possibility to build the hose assemblies into fixed distances/spaces, without having to move back other system components due the flat faces of the male and female fittings – the hose assembly can be slotted in.

Standard
ISO 12151-1, ISO8434-3 and SAE J516

Parker end configurations
JC, JM/J0, JS, JU, J1, J3, J5, J7, J9

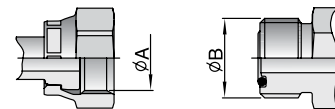

| Tube I.D inch | Tube O.D. mm | Thread UNF | Size | ØA mm | ØB mm |
|------------------|-----------------|---------------|------|----------|----------|
| 1/4 | 6 | 9/16x18 | -4 | 13.00 | 14.20 |
| 3/8 | 10 | 11/16x16 | -6 | 15.90 | 17.50 |
| 1/2 | 12 | 13/16x16 | -8 | 19.10 | 20.60 |
| 5/8 | 16 | 1x14 | -10 | 23.80 | 25.40 |
| 3/4 | 20 | 1-3/16x12 | -12 | 28.20 | 30.10 |
| 1 | 25 | 1-7/16x12 | -16 | 34.15 | 36.50 |
| 1-1/4 | 32 | 1-11/16x12 | -20 | 40.50 | 42.90 |
| 1-1/2 | 38 | 2x12 | -24 | 48.80 | 50.80 |

F Tooling, Equipment, & Accessories

G General Technical

Japanese Fittings

JIS

The Japanese Industrial Standard (JIS) is seen on most Japanese equipment and uses a 30° sealing angle seat and either British Standard Pipe Parallel or metric threads. Care must be taken not to confuse the JIS fittings with BSP or JIC fittings.

Japanese Fittings - JIS

The sealing mechanism of the fittings is the 30° metal-to-metal angled surfaces.

Parker end configurations
MU, XU (Metric), FU (BSP)

JIS 30° Metric

| Symbol | Thread metric | ØA mm | ØB mm |
|--------|------------------|----------|----------|
| MU-6 | M14x1.5 | 12.50 | 14.00 |
| MU-9 | M18x1.5 | 16.50 | 18.00 |
| MU-12 | M22x1.5 | 20.50 | 22.00 |
| MU-15 | M27x2 | 25.00 | 27.00 |
| MU-19 | M27x2 | 25.00 | 27.00 |
| MU-25 | M33x2 | 31.00 | 33.00 |
| MU-32 | M42x2 | 40.00 | 42.00 |
| MU-38 | M50x2 | 48.00 | 50.00 |
| MU-50 | M60x2 | 58.00 | 60.00 |

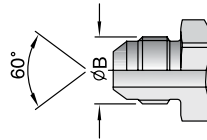

JIS 30° BSP

| Symbol | Thread BSP | ØA mm | ØB mm |
|------------|---------------|----------|----------|
| GUI-3 | 1/8x28 | 8.60 | 9.70 |
| GUI-5/-6 | 1/4x19 | 11.50 | 13.20 |
| GUI-8/-9 | 3/8x19 | 14.90 | 16.70 |
| GUI-12 | 1/2x14 | 18.60 | 20.90 |
| GUI-15/-19 | 3/4x14 | 24.10 | 26.40 |
| GUI-25 | 1x11 | 30.30 | 33.20 |
| GUI-32 | 1-1/4x11 | 38.90 | 41.90 |
| GUI-38 | 1-1/2x11 | 44.90 | 47.80 |
| GUI-50 | 2x11 | 56.70 | 59.60 |

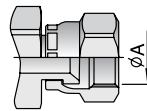



Fitting Thread Guide For Hose

Thread Size - Inch

There are more than one hundred types of threads for fittings. Below are some of the most common thread styles offered by Parflex.

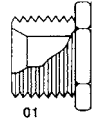
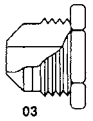
The end code in a fitting part number is located directly after the first digit. i.e. 1C356-10-6

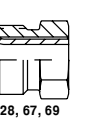
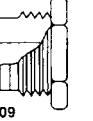
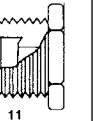
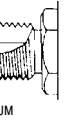
| End Code |  01 |  03 |  04 |  05 |  28, 67, 69 |  09 |  11 |  JM |
|-----------|--|--|--|--|---|--|--|--|
| Dash Size | NPTF Pipe Thread Size | SAE (JIC) 37° Flare Thread Size | SAE 45° Flare Thread Size | “O” Ring Style Straight Thread Size | SAE Inverted Flare Thread Size | PTT 30° Flare Thread Size | SAE Flareless Thread Size | Seal-Lok™ Thread |
| 2 | 1/8 - 27 | 5/16 - 24 | 5/16 - 24 | 5/16 - 24 | - | - | 5/16 - 24 | - |
| 3 | - | 3/8 - 24 | 3/8 - 24 | 3/8 - 24 | 3/8 - 24 | - | 3/8 - 24 | - |
| 4 | 1/4 - 18 | 7/16 - 20 | 7/16 - 20 | 7/16 - 20 | 7/16 - 18 | - | 7/16 - 20 | 9/16 - 18 |
| 5 | - | 1/2 - 20 | 1/2 - 20 | 1/2 - 20 | 1/2 - 20 | - | 1/2 - 20 | - |
| 6 | 3/8 - 18 | 9/16 - 18 | 5/8 - 18 | 9/16 - 18 | 5/8 - 18 | - | 9/16 - 18 | 11/16 - 16 |
| 8 | 1/2 - 14 | 3/4 - 16 | 3/4 - 16 | 3/4 - 16 | 3/4 - 18 | - | 3/4 - 16 | 13/16 - 16 |
| 10 | - | 7/8 - 14 | 7/8 - 14 | 7/8 - 14 | 7/8 - 18 | - | 7/8 - 14 | 1 - 14 |
| 12 | 3/4 - 14 | 1 1/16 - 12 | 1 1/16 - 14 | 1 1/16 - 12 | 1 1/16 - 16 | - | 1 1/16 - 12 | 1 3/16 - 12 |
| 14 | - | 1 3/16 - 12 | - | 1 3/16 - 12 | - | - | 1 3/16 - 12 | - |
| 16 | 1 - 11 1/2 | 1 5/16 - 12 | - | 1 5/16 - 12 | - | 1 5/16 - 14 | 1 5/16 - 12 | 1 7/16 - 12 |
| 20 | 1 1/4 - 11 1/2 | 1 5/8 - 12 | - | 1 5/8 - 12 | - | 1 5/8 - 14 | 1 5/8 - 12 | - |
| 24 | 1 1/2 - 11 1/2 | 1 7/8 - 12 | - | 1 7/8 - 12 | - | 1 7/8 - 14 | 1 7/8 - 12 | - |
| 32 | 2 - 11 1/2 | 2 1/2 - 12 | - | 2 1/2 - 12 | - | 2 1/2 - 12 | 2 1/2 - 12 | - |



(Cont.)

Fitting Thread Guide For Hose

Thread Size - Metric

There are more than one hundred types of threads for fittings. Below are some of the most common thread styles offered by Parflex.

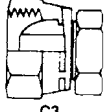
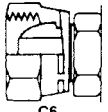
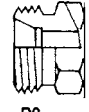
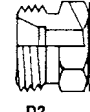
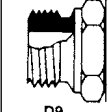
The end code in a fitting part number is located directly after the first digit. i.e. 1C356-10-6

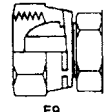
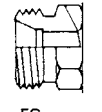
| End Code |  |  |  |  |  |  |  |  |  |
|-----------|---|---|---|---|---|--|---|---|---|
| Dash Size | Metric Swivel Female Thread Size | Metric Swivel Female Thread Size | Male Stud Thread Size | Male Stud Thread Size | Male BSPP Thread Size | BSP Swivel Female Thread Size | French Swivel Female Gas Series | French Swivel Female Metric Series | French Male Stud Gas Series |
| 4 | - | - | - | - | 1/4" | 1/4" | - | - | - |
| 6 | M12 x 1,5 | - | M12 x 1,5 | - | 3/8" | 3/8" | - | M12 x 1 | - |
| 8 | M14 x 1,5 | M16 x 1,5 | M14 x 1,5 | M16 x 1,5 | 1/2" | 1/2" | - | M14 x 1,5 | - |
| 10 | M16 x 1,5 | M18 x 1,5 | M16 x 1,5 | M18 x 1,5 | - | 5/8" | - | M16 x 1,5 | - |
| 12 | M18 x 1,5 | M20 x 1,5 | M18 x 1,5 | M20 x 1,5 | 3/4" | 3/4" | - | M18 x 1,5 | - |
| - | - | - | - | - | - | - | M20 x 1,5 | - | M20 x 1,5 |
| 14 | - | M22 x 1,5 | - | M22 x 1,5 | - | - | - | M20 x 1,5 | - |
| 15 | M22 x 1,5 | - | M22 x 1,5 | - | - | - | - | M22 x 1,5 | - |
| 16 | - | M24 x 1,5 | - | M24 x 1,5 | 1" | 1" | - | M24 x 1,5 | - |
| - | - | - | - | - | - | - | M24 x 1,5 | - | M24 x 1,5 |
| 18 | M26 x 1,5 | - | M26 x 1,5 | - | - | - | - | M27 x 1,5 | - |
| 20 | - | M30 x 2 | - | M30 x 2 | - | - | - | M27 x 1,5 | - |
| - | - | - | - | - | - | - | M30 x 1,5 | - | M30 x 1,5 |
| 22 | M30 x 2 | - | M30 x 2 | - | - | - | - | M30 x 1,5 | - |
| 25 | - | M36 x 2 | - | M36 x 2 | - | - | - | M33 x 1,5 | - |
| - | - | - | - | - | - | - | M36 x 1,5 | - | M36 x 1,5 |
| 28 | M36 x 2 | - | M36 x 2 | - | - | - | - | - | - |
| 30 | - | M42 x 2 | - | M42 x 2 | - | - | - | M39 x 1,5 | - |
| 33 | - | - | - | - | - | - | M45 x 1,5 | - | M45 x 1,5 |

A Hose

B Tubing Thermoplastic

C Coiled Air Hose & Fittings

D Transportation

E Fittings

F Tooling, Equipment & Accessories

G General Technical

Media to Fitting Compatibility

A Hose

| Media | Fitting Material | | |
|-------------------------------|------------------|-------|--------|
| | Brass | Steel | 316 SS |
| Acetylene | NR | F | S |
| Air (oil free) @ 190° F | S | F | S |
| Air (oil free) @ 300° F | S | F | S |
| Air (oil free) @ 400° F | S | F | S |
| Alcohol, Ethyl | S | NR | NR |
| Animal Oils (Lard Oil) | F | F | F |
| Aromatic Fuel - 50% | ID | ID | ID |
| Aromatic Solvents | ID | ID | F |
| Asphalt | NR | NR | S |
| ASTM Oil #1 | S | S | S |
| ASTM Oil #2 | S | S | S |
| ASTM Oil #3 | S | S | S |
| ASTM Oil #4 | S | S | S |
| ATF Oil | S | S | S |
| Automotive Brake Fluid | ID | ID | ID |
| Benzene | NR | F | NR |
| Brine (Sodium Chloride) | NR | NR | S |
| Butane | NR | S | S |
| Carbon Dioxide | S | F | S |
| Carbon Monoxide | S | S | S |
| Chlorine (Dry) | F | F | NR |
| Compressed Air | S | F | S |
| Crude Oil | NR | F | S |
| Cutting Oil | ID | S | S |
| Diesel Fuel | S | S | S |
| Ethanol | S | NR | NR |
| Ethers | S | S | S |
| Freon 11 | S | ID | ID |
| Freon 12 | S | S | NR |
| Freon 22 | S | NR | S |
| Fuel Oil | NR | S | S |
| Gasoline | S | F | S |
| Gas, Liquid Propane (LPG) | S | S | S |
| Gas, Natural | F | S | S |
| Helium | S | S | S |
| Hydraulic Oil, Petroleum Base | S | S | S |
| Hydraulic Oil, Water Base | ID | S | S |
| Hydrogen Gas | S | S | S |
| Jet Fuel | S | S | S |

B Tubing Thermoplastic

| Media | Fitting Material | | |
|--|------------------|-------|--------|
| | Brass | Steel | 316 SS |
| Kerosene | S | S | S |
| Lubricating Oil SAE 10, 20, 30, 40, 50 | S | S | S |
| Methanol | S | S | S |
| MIL-F-8192 (JP-9) | S | S | S |
| MIL-H-5606 | S | S | S |
| MIL-H-6083 | S | S | S |
| MIL-H-7083 | S | S | S |
| MIL-H-8446 (MLO-8515) | F | S | S |
| Mil-L-2104 & 2104B | S | S | S |
| MIL-L-7808 | NR | F | S |
| Mineral Oil | S | S | S |
| Nitrogen | S | S | S |
| Petrolatum | S | S | S |
| Petroleum Oil (<250° F) | S | S | S |
| Propane | S | S | S |
| R134A | S | S | S |
| Sea Water | F | NR | S |
| Skydrol 500, Type 2 | NR | S | S |
| Skydrol 7000, Type 2 | NR | S | S |
| Soap Solutions | NR | NR | S |
| Steam (<400° F) | F | S | S |
| Stoddard Solvent | F | S | S |
| Transmission Fluid (Type A) | S | S | S |
| Trichloroethane | ID | F | S |
| Water | S | F | S |

C Coiled Air Hose & Fittings

D Transportation

M Fittings

T Tooling, Equipment, & Accessories

G General Technical

Rating Codes

- S = Satisfactory
- F = Fair
- NR = Not recommended
- ID = Insufficient data

Metals Corrosion Scale

Electromotive or Galvanic Series for Metals

The susceptibility of different base metals to corrosion while in contact depends upon the difference between the contact potentials or the electromotive voltages of the metals involved. The greater the potential difference is, the greater is the tendency for corrosion. The metal with the higher potential forms the anode and is corroded. The larger the separation distance in the electromotive chart between the two metals in contact, the higher the contact potential and chances for corrosion. For example, zinc and aluminum are very short distance apart in the chart; therefore potential for corrosion when these two metals are in contact is very low. On the other hand, aluminum and passivated 316 stainless steel are far apart; hence, when in contact, the potential for corrosion is very high. Aluminum, being more anodic metal, will corrode in this combination.

As a general guideline, if the metals are half the length of the chart or more apart, the combination should be avoided. Also, it is not a good idea to combine an anodic metal part with thin cross section, such as thin wall tubing, with a cathodic or less anodic metal part of a heavy cross section, such as a fitting.

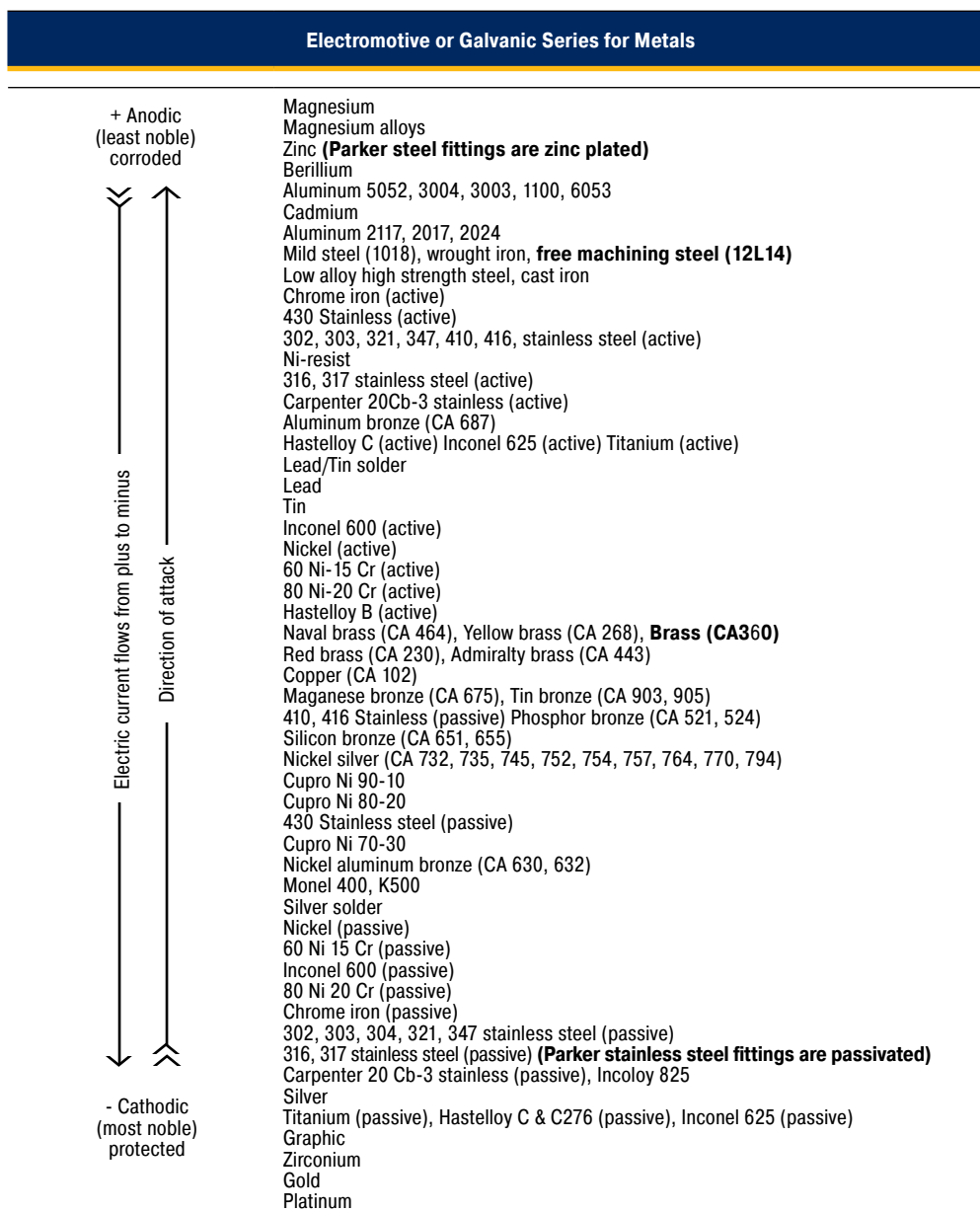

A Hose

B Tubing Thermoplastic

C Coiled Air Hose & Fittings

D Transportation

E Fittings

F Tooling, Equipment & Accessories

G General Technical

Fittings - Field Attachable

51 Series

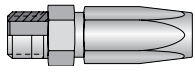
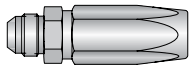
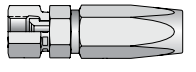
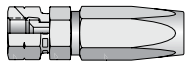
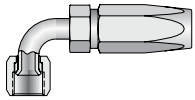
| | | | | | | | | | | |
|-------------------------------|---|-----------------------|---|----------------------|--|----------------------|---|----------------|---|-------------------------------------|
| 51 Series Field Attachable | 201 | Male Taper Pipe Rigid | 203 | Male (JIC) 37° Rigid | 206 | SAE (JIC) 37° Swivel | 208 | SAE 45° Swivel | 239 | JIC 37° Swivel 90° Elbow Short Drop |
| |  | |  | |  | |  | |  | |
| | E-22 | | E-22 | | E-23 | | E-23 | | E-23 | |

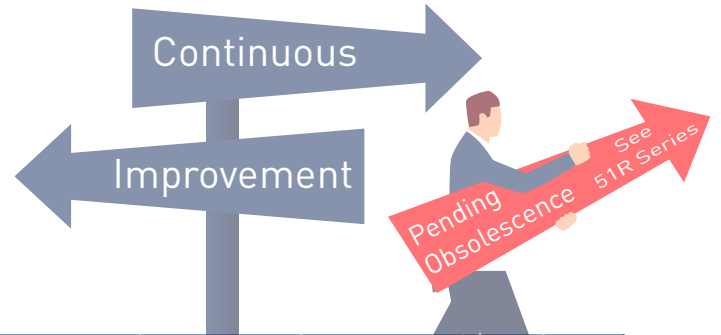

20151 Male Taper Pipe Rigid

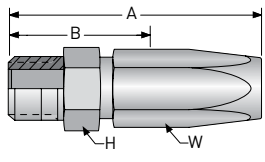

Construction: Steel.

| Part Number | Thread Size | Hose I.D. | | A | | Cutoff Allow. B | | H Hex inch | W Hex inch |
|-------------|-------------|-----------|----|------|----|-----------------|----|------------|------------|
| | | inch | mm | inch | mm | inch | mm | | |
| 20151-2-3 | 1/8-27 | 3/16 | 5 | 1.71 | 43 | 1 | 25 | 7/16 | 5/8 |
| 20151-4-3 | 1/4-18 | 3/16 | 5 | 1.90 | 48 | 1-1/8 | 29 | 9/16 | 5/8 |
| 20151-2-4 | 1/8-27 | 1/4 | 6 | 1.90 | 48 | 1 | 25 | 1/2 | 5/8 |
| 20151-4-4 | 1/4-18 | 1/4 | 6 | 2.08 | 53 | 1-3/16 | 30 | 9/16 | 5/8 |
| 20151-4-5 | 1/4-18 | 5/16 | 8 | 2.17 | 55 | 1-7/16 | 37 | 9/16 | 3/4 |
| 20151-6-5 | 3/8-18 | 5/16 | 8 | 2.17 | 55 | 1-7/16 | 37 | 3/4 | 3/4 |
| 20151-4-6 | 1/4-18 | 3/8 | 10 | 2.61 | 66 | 1-7/16 | 37 | 3/4 | 7/8 |
| 20151-6-6 | 3/8-18 | 3/8 | 10 | 2.61 | 66 | 1-7/16 | 37 | 3/4 | 7/8 |
| 20151-8-6 | 1/2-14 | 3/8 | 10 | 2.80 | 71 | 1-9/16 | 40 | 7/8 | 7/8 |
| 20151-6-8 | 3/8-18 | 1/2 | 13 | 2.99 | 76 | 1-1/2 | 38 | 7/8 | 1-1/16 |
| 20151-8-8 | 1/2-14 | 1/2 | 13 | 3.17 | 81 | 1-11/16 | 43 | 7/8 | 1-1/16 |
| 20151-12-12 | 3/4-14 | 3/4 | 19 | 3.42 | 87 | 1-3/4 | 44 | 1-1/8 | 1-3/8 |
| 20151-16-16 | 1-11-1/2 | 1 | 25 | 3.74 | 95 | 2-1/4 | 57 | 1-3/8 | 1-9/16 |

20351 Male (JIC) 37° Rigid

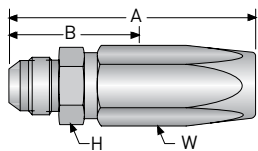

Construction: Steel.

| Part Number | Thread Size | Hose I.D. | | A | | Cutoff Allow. B | | H Hex inch | W Hex inch |
|-------------|-------------|-----------|----|------|----|-----------------|----|------------|------------|
| | | inch | mm | inch | mm | inch | mm | | |
| 20351-4-3 | 7/16-20 | 3/16 | 5 | 1.88 | 48 | 1-1/8 | 29 | 1/2 | 5/8 |
| 20351-5-4 | 1/2-20 | 1/4 | 6 | 2.06 | 52 | 1-1/8 | 29 | 9/16 | 5/8 |
| 20351-6-5 | 9/16-18 | 5/16 | 8 | 2.16 | 55 | 1-5/16 | 33 | 5/8 | 3/4 |
| 20351-6-6 | 9/16-18 | 3/8 | 10 | 2.61 | 66 | 1-7/16 | 37 | 3/4 | 7/8 |
| 20351-8-6 | 3/4-16 | 3/8 | 10 | 2.71 | 69 | 1-7/16 | 37 | 13/16 | 7/8 |
| 20351-8-8 | 3/4-16 | 1/2 | 13 | 3.08 | 78 | 1-5/8 | 41 | 7/8 | 1-1/16 |

WARNING

This product can expose you to chemicals including Lead, which is known to the State of California to cause cancer and birth defects or other reproductive harm. For more information go to www.P65Warnings.ca.gov.

Fittings - Field Attachable

51 Series

20651 SAE (JIC) 37° Swivel

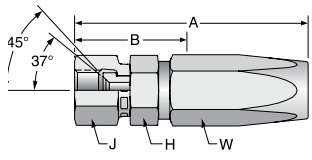

Construction: Steel.

| Part Number | Thread Size | Hose I.D. | | A | | Cutoff Allow. B | | H Hex | J Hex | W Hex |
|-------------|-------------|-----------|----|------|----|-----------------|----|-------|-------|--------|
| | | inch | mm | inch | mm | inch | mm | inch | inch | inch |
| 20651-4-3 | 7/16-20 | 3/16 | 5 | 1.99 | 51 | 1-1/4 | 32 | 9/16 | 9/16 | 5/8 |
| 20651-4-4 | 7/16-20 | 1/4 | 6 | 2.18 | 55 | 1-1/4 | 32 | 9/16 | 9/16 | 5/8 |
| 20651-5-4 | 1/2-20 | 1/4 | 6 | 2.24 | 57 | 1-7/16 | 37 | 5/8 | 5/8 | 5/8 |
| 20651-6-4 | 9/16-18 | 1/4 | 6 | 2.34 | 59 | 1-7/16 | 37 | 11/16 | 11/16 | 5/8 |
| 20651-6-5 | 9/16-18 | 5/16 | 8 | 2.37 | 60 | 1-1/2 | 38 | 11/16 | 11/16 | 3/4 |
| 20651-6-6 | 9/16-18 | 3/8 | 10 | 2.74 | 70 | 1-7/16 | 37 | 11/16 | 11/16 | 7/8 |
| 20651-8-6 | 3/4-16 | 3/8 | 10 | 2.88 | 73 | 1-5/8 | 41 | 7/8 | 7/8 | 7/8 |
| 20651-8-8 | 3/4-16 | 1/2 | 13 | 3.25 | 83 | 1-3/4 | 44 | 7/8 | 7/8 | 1-1/16 |
| 20651-10-8 | 7/8-14 | 1/2 | 13 | 3.37 | 86 | 1-7/8 | 48 | 1 | 1 | 1-1/16 |
| 20651-12-12 | 1-1/16-12 | 3/4 | 19 | 3.75 | 95 | 2-1/8 | 54 | 1-1/4 | 1-1/4 | 1-3/8 |
| 20651-16-16 | 1-5/16-12 | 1 | 25 | 3.87 | 98 | 2-1/4 | 57 | 1-1/2 | 1-1/2 | 1-9/16 |

NOTE: Sizes -4, -5, -8 and -10 incorporate a dual seat.

20851 SAE 45° Swivel

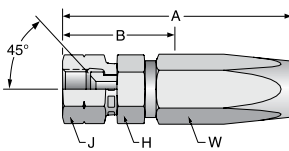

Construction: Steel.

| Part Number | Thread Size | Hose I.D. | | A | | Cutoff Allow. B | | H Hex | J Hex | W Hex |
|-------------|-------------|-----------|----|------|----|-----------------|----|-------|-------|-------|
| | | inch | mm | inch | mm | inch | mm | inch | inch | inch |
| 20851-6-6 | 5/8-18 | 3/8 | 10 | 2.82 | 72 | 1-9/16 | 40 | 3/4 | 3/4 | 7/8 |

23951 JIC 37° Swivel 90° Elbow Short Drop

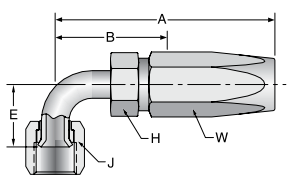

Construction: Steel.



| Part Number | Thread Size | Hose I.D. | | A | | Cutoff Allow. B | | H Hex | J Hex | W Hex |
|-------------|-------------|-----------|----|------|----|-----------------|----|-------|-------|-------|
| | | inch | mm | inch | mm | inch | mm | inch | inch | inch |
| 23951-4-3 | 7/16-20 | 3/16 | 5 | 1.77 | 45 | 1 | 25 | 0.83 | 21 | 3/8 |
| 23951-6-6 | 9/16-18 | 3/8 | 10 | 2.70 | 69 | 1-7/16 | 37 | 0.85 | 22 | 9/16 |
| 23951-8-6 | 3/4-16 | 3/8 | 10 | 2.90 | 74 | 1-5/8 | 41 | 1.09 | 28 | 11/16 |

WARNING

This product can expose you to chemicals including Lead, which is known to the State of California to cause cancer and birth defects or other reproductive harm. For more information go to www.P65Warnings.ca.gov.

Fittings - Field Attachable

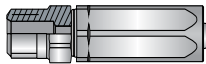
51R Series

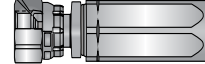
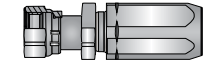
| | | | | | | | | |
|--------------------------------|---|-----------------------|---|----------------------|---|-----------------------------|---|-------------------------------------|
| 51R Series Field Attachable | 201 | Male Taper Pipe Rigid | 203 | Male (JIC) 37° Rigid | 206 | Female SAE (JIC) 37° Swivel | 2JS | Female Seal-Lok Swivel Straight Lg. |
| |  | |  | |  | |  | |
| | E-24 | | E-24 | | E-25 | | E-25 | |

20151R Male Taper Pipe Rigid

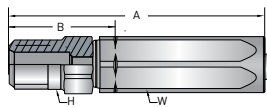

Construction: Steel.

| Part Number | Thread Size | Hose I.D. | | A | | Cutoff Allow. B | | H Hex | W Hex |
|-------------|-------------|-----------|----|------|----|-----------------|----|-------|--------|
| | | inch | mm | inch | mm | inch | mm | inch | inch |
| 20151R-4-3 | 1/4-18 | 3/16 | 5 | 2.59 | 66 | 1-1/8 | 29 | 9/16 | 5/8 |
| 20151R-4-4 | 1/4-18 | 1/4 | 6 | 2.67 | 68 | 1-1/8 | 29 | 9/16 | 5/8 |
| 20151R-6-6 | 3/8-18 | 3/8 | 10 | 2.90 | 74 | 1-5/16 | 33 | 3/4 | 7/8 |
| 20151R-8-8 | 1/2-14 | 1/2 | 13 | 3.32 | 84 | 1-1/2 | 39 | 7/8 | 1-1/16 |

20351R Male (JIC) 37° Rigid

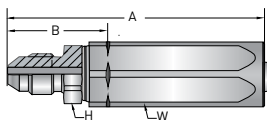

Construction: Steel.

| Part Number | Thread Size | Hose I.D. | | A | | Cutoff Allow. B | | H Hex | W Hex |
|-------------|-------------|-----------|----|------|----|-----------------|----|-------|--------|
| | | inch | mm | inch | mm | inch | mm | inch | inch |
| 20351R-4-3 | 7/16-20 | 3/16 | 5 | 2.54 | 65 | 1-1/8 | 29 | 1/2 | 5/8 |
| 20351R-4-4 | 7/16-20 | 1/4 | 6 | 2.63 | 67 | 1-1/8 | 29 | 1/2 | 5/8 |
| 20351R-6-6 | 9/16-18 | 3/8 | 10 | 2.61 | 66 | 1-7/16 | 37 | 3/4 | 7/8 |
| 20351R-8-8 | 3/4-16 | 1/2 | 13 | 3.08 | 78 | 1-5/8 | 41 | 7/8 | 1-1/16 |

WARNING

This product can expose you to chemicals including Lead, which is known to the State of California to cause cancer and birth defects or other reproductive harm. For more information go to www.P65Warnings.ca.gov.

E-24 Parker Hannifin Corporation | Parflex Division | Ravenna, Ohio | parker.com/pfd

updated Oct. 2, 2023

Fittings - Field Attachable

51R Series

20651R SAE (JIC) 37° Swivel

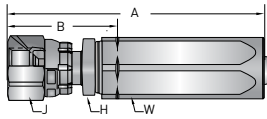

Construction: Steel.

| Part Number | Thread Size | Hose I.D. | | A | | Cutoff Allow. B | | H Hex | J Hex | W Hex |
|-------------|-------------|-----------|----|------|----|-----------------|----|-------|-------|--------|
| | | inch | mm | inch | mm | inch | mm | inch | inch | inch |
| 20651R-4-3 | 7/16-20 | 3/16 | 5 | 2.56 | 65 | 1-1/8 | 29 | 9/16 | 9/16 | 5/8 |
| 20651R-4-4 | 7/16-20 | 1/4 | 6 | 2.65 | 67 | 1-1/8 | 29 | 9/16 | 9/16 | 5/8 |
| 20651R-6-6 | 9/16-18 | 3/8 | 10 | 2.93 | 75 | 1-5/16 | 33 | 11/16 | 11/16 | 7/8 |
| 20651R-8-8 | 3/4-16 | 1/2 | 13 | 3.30 | 84 | 1-1/2 | 39 | 7/8 | 7/8 | 1-1/16 |

2JS51R Female Seal-Lok - Swivel - Straight - Long

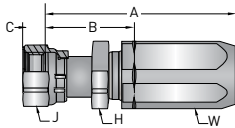

Construction: Steel.

| Part Number | Thread Size | Hose I.D. | | A | | Cutoff Allow. B | | H Hex | J Hex | W Hex |
|-------------|-------------|-----------|----|------|----|-----------------|----|-------|-------|--------|
| | | inch | mm | inch | mm | inch | mm | inch | inch | inch |
| 2JS51R-6-6 | 9/16-18 | 3/8 | 10 | 2.83 | 72 | 1-1/4 | 32 | 13/16 | 13/16 | 7/8 |
| 2JS51R-8-8 | 3/4-16 | 1/2 | 13 | 3.13 | 80 | 1-3/8 | 35 | 15/16 | 15/16 | 1-1/16 |

NOTE: When measuring overall length to the end of the nut, B+C dimensions must be used to calculate cut-off allowance.







WARNING

This product can expose you to chemicals including Lead, which is known to the State of California to cause cancer and birth defects or other reproductive harm. For more information go to www.P65Warnings.ca.gov.

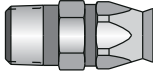
Fittings - Field Attachable

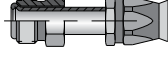
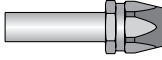
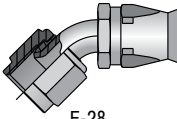
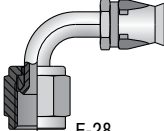
90 Series

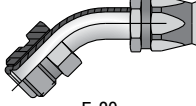
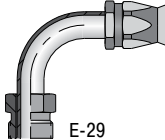
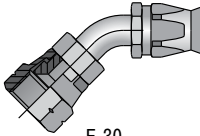
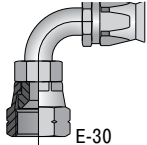
| | | | | | | | | | | |
|-------------------------------|---|--------------------------|---|--------------------------------|---|---------------------------|---|------------------------------------|---|------------------------------------|
| 90 Series Field Attachable | 201 | Male Taper Pipe Rigid | 206 | SAE (JIC) 37° Swivel | 208 | SAE 45° Swivel | 228 | SAE Male Inverted Swivel Straight | 234 | Straight Tube |
| |  | |  | |  | |  | |  | |
| | E-26 | | E-27 | | E-27 | | E-27 | | E-28 | |
| Coiled Air Hose & Fittings | 237 | JIC 37° Swivel 45° Elbow | 239 | JIC 37° Swivel 90° Elbow Short | 261 | SAE Compression Air Brake | 267 | SAE Male Inverted Swivel 45° Elbow | 269 | SAE Male Inverted Swivel 90° Elbow |
| |  | |  | |  | |  | |  | |
| | E-28 | | E-28 | | E-29 | | E-29 | | E-29 | |
| Coiled Air Hose & Fittings | 277 | SAE 45° Swivel 45° Elbow | 279 | SAE 45° Swivel 90° Elbow | | | | | | |
| |  | |  | | | | | | | |
| E-30 | | E-30 | | | | | | | | |

20190 Male Taper Pipe Rigid

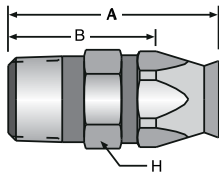

Construction: Brass nipple and ferrule, steel socket. Add "C" for Stainless Steel.

| Part Number | Thread Size | Hose Size | A | | Cutoff Allow. B | | H Hex inch |
|-------------|--------------|-----------|------|----|-----------------|----|------------|
| | | | inch | mm | inch | mm | |
| 20190-2-4 | 1/8-27 | -4 | 1.33 | 34 | 7/8 | 22 | 9/16 |
| 20190-4-4 | 1/4-18 | -4 | 1.58 | 40 | 1-1/16 | 27 | 9/16 |
| 20190-4-5 | 1/4-18 | -5 | 1.66 | 42 | 1-1/8 | 29 | 5/8 |
| 20190-4-6 | 1/4-18 | -6 | 1.66 | 42 | 1-1/8 | 29 | 11/16 |
| 20190-6-6 | 3/8-18 | -6 | 1.66 | 42 | 1-1/8 | 29 | 11/16 |
| 20190-6-8 | 3/8-18 | -8 | 1.77 | 45 | 1-3/16 | 30 | 7/8 |
| 20190-8-8 | 1/2-14 | -8 | 1.97 | 50 | 1-7/16 | 37 | 7/8 |
| 20190-8-10 | 1/2-14 | -10 | 2.13 | 54 | 1-7/16 | 37 | 1 |
| 20190-12-12 | 3/4-14 | -12 | 2.26 | 57 | 1-9/16 | 40 | 1-1/8 |
| 20190-12-16 | 3/4-14 | -16 | 2.29 | 58 | 1-5/8 | 41 | 1-3/8 |
| 20190-16-16 | 1-11-1/2 | -16 | 2.46 | 62 | 1-7/8 | 48 | 1-3/8 |
| 20190-20-20 | 1-1/4-11-1/2 | -20 | 2.69 | 68 | 2-1/8 | 52 | 2 |

WARNING

This product can expose you to chemicals including Lead, which is known to the State of California to cause cancer and birth defects or other reproductive harm. For more information go to www.P65Warnings.ca.gov.

Fittings - Field Attachable

90 Series

20690 SAE (JIC) 37° Swivel

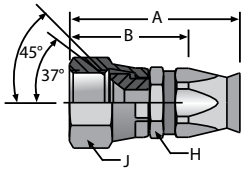

Construction: Brass nipple and ferrule, steel socket. Add "C" for Stainless Steel.

| Part Number | Thread Size | Hose Size | A | | Cutoff Allow. B | | H Hex inch | J Hex inch |
|-------------|-------------|-----------|------|----|-----------------|----|------------|------------|
| | | | inch | mm | inch | mm | | |
| 20690-4-4 | 7/16-20 | -4 | 1.58 | 40 | 1-1/8 | 29 | 9/16 | 9/16 |
| 20690-5-5 | 1/2-20 | -5 | 1.66 | 42 | 1-1/8 | 29 | 5/8 | 5/8 |
| 20690-6-6 | 9/16-18 | -6 | 1.74 | 44 | 1-3/16 | 35 | 11/16 | 11/16 |
| 20690-8-6 | 3/4-16 | -6 | 1.85 | 47 | 1-5/16 | 33 | 7/8 | 7/8 |
| 20690-8-8 | 3/4-16 | -8 | 1.98 | 50 | 1-3/8 | 35 | 7/8 | 7/8 |
| 20690-8-10 | 3/4-16 | -10 | 2.07 | 53 | 1-7/16 | 37 | 1 | 7/8 |
| 20690-10-10 | 7/8-14 | -10 | 2.22 | 56 | 1-1/2 | 38 | 1 | 1 |
| 20690-12-12 | 1-1/16-12 | -12 | 2.33 | 59 | 1-5/8 | 41 | 1-1/4 | 1-1/4 |
| 20690-16-16 | 1-5/16-12 | -16 | 2.52 | 64 | 1-15/16 | 49 | 1-3/8 | 1-1/2 |
| 20690-20-20 | 1-5/8-12 | -20 | 2.99 | 76 | 2-5/16 | 59 | 2 | 2 |

NOTE: Sizes -4, -5, -8 and -10 incorporate a dual seat.

20890 SAE 45° Swivel

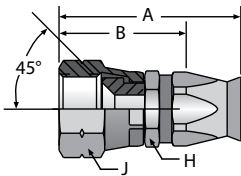

Construction: Brass nipple and ferrule, steel socket. Add "C" for Stainless Steel.

| Part Number | Thread Size | Hose Size | A | | Cutoff Allow. B | | H Hex inch | J Hex inch |
|-------------|-------------|-----------|------|----|-----------------|----|------------|------------|
| | | | inch | mm | inch | mm | | |
| 20890-6-6 | 5/8-18 | -6 | 1.77 | 45 | 1-1/4 | 32 | 11/16 | 3/4 |
| 20890-12-12 | 1-1/16-14 | -12 | 2.34 | 59 | 1-11/16 | 43 | 1-1/8 | 1-1/4 |

22890 SAE Male Inverted Swivel Straight

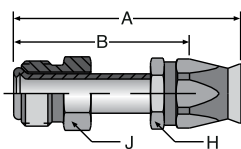

Construction: Steel nipple, nut and socket. Add "C" for Stainless Steel.

| Part Number | Thread Size | Hose Size | A | | Cutoff Allow. B | | H Hex inch | J Hex inch |
|-------------|-------------|-----------|------|----|-----------------|----|------------|------------|
| | | | inch | mm | inch | mm | | |
| 22890-4-4 | 7/16-24 | -4 | 2.15 | 55 | 1-11/16 | 43 | 9/16 | 7/16 |
| 22890-5-5 | 1/2-20 | -5 | 2.21 | 56 | 1-11/16 | 43 | 5/8 | 1/2 |
| 22890-5-6 | 1/2-20 | -6 | 2.20 | 56 | 1-11/16 | 43 | 11/16 | 1/2 |
| 22890-6-6 | 5/8-18 | -6 | 2.22 | 56 | 1-11/16 | 43 | 11/16 | 5/8 |
| 22890-8-8 | 3/4-18 | -8 | 2.34 | 59 | 1-13/16 | 46 | 13/16 | 3/4 |
| 22890-10-10 | 7/8-18 | -10 | 2.53 | 64 | 1-7/8 | 48 | 15/16 | 7/8 |
| 22890-12-12 | 1-1/16-16 | -12 | 3.01 | 76 | 2-3/8 | 60 | 1-1/8 | 1-1/16 |

WARNING

This product can expose you to chemicals including Lead, which is known to the State of California to cause cancer and birth defects or other reproductive harm. For more information go to www.P65Warnings.ca.gov.

Fittings - Field Attachable

90 Series

23490 Straight Tube

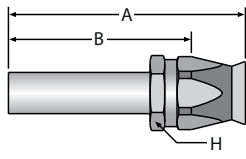

Construction: Brass nipple and ferrule, steel socket.

| Part Number | Hose Size | Tube Size | | A | | Cutoff Allow. B | | H Hex |
|-------------|-----------|-----------|----|------|----|-----------------|----|-------|
| | | inch | mm | inch | mm | inch | mm | inch |
| 23490-8-8 | -8 | 1/2 | 6 | 3.06 | 78 | 2-1/2 | 64 | 13/16 |
| 23490-8-10 | -10 | 1/2 | 8 | 3.15 | 80 | 2-1/2 | 64 | 1 |
| 23490-10-8 | -8 | 5/8 | 8 | 3.26 | 83 | 2-5/8 | 67 | 13/16 |
| 23490-10-10 | -10 | 5/8 | 10 | 3.28 | 83 | 2-5/8 | 67 | 1 |
| 23490-12-12 | -12 | 3/4 | 13 | 3.28 | 83 | 2-11/16 | 68 | 1-1/8 |

NOTE: 26T90 fitting includes 23490 with the 60HAB sleeve & 61HAB nut.

23790 JIC 37° Swivel 45° Elbow

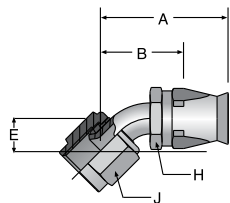

Construction: Steel nipple, nut and socket. Add "C" for Stainless Steel.

| Part Number | Thread Size | Hose Size | A | | Cutoff Allow. B | | E | | H Hex | J Hex |
|-------------|-------------|-----------|------|----|-----------------|----|------|----|-------|-------|
| | | | inch | mm | inch | mm | inch | mm | inch | inch |
| 23790-4-4 | 7/16-20 | -4 | 1.79 | 45 | 1-3/8 | 35 | 0.33 | 8 | 9/16 | 9/16 |
| 23790-5-5 | 1/2-20 | -5 | 1.86 | 47 | 1-3/8 | 35 | 0.36 | 9 | 5/8 | 5/8 |
| 23790-6-6 | 9/16-18 | -6 | 1.96 | 50 | 1-7/16 | 37 | 0.39 | 10 | 11/16 | 11/16 |
| 23790-8-6 | 3/4-16 | -6 | 2.11 | 54 | 1-11/16 | 43 | 0.55 | 14 | 11/16 | 7/8 |
| 23790-8-8 | 3/4-16 | -8 | 2.40 | 61 | 1-3/4 | 44 | 0.55 | 14 | 13/16 | 7/8 |
| 23790-10-10 | 7/8-14 | -10 | 2.45 | 62 | 1-7/8 | 48 | 0.63 | 16 | 15/16 | 1 |
| 23790-12-12 | 1-1/16-12 | -12 | 3.04 | 77 | 2-7/16 | 62 | 0.78 | 20 | 1-1/8 | 1-1/4 |
| 23790-16-16 | 1-5/16-12 | -16 | 3.28 | 83 | 2-11/16 | 68 | 0.90 | 23 | 1-3/8 | 1-1/2 |
| 23790-20-20 | 1-5/8-12 | -20 | 3.70 | 94 | 3-1/16 | 78 | 1.18 | 30 | 1-3/4 | 2 |

23990 JIC 37° Swivel 90° Elbow Short Drop

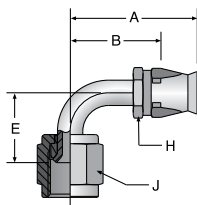

Construction: Steel nipple, nut and socket. Add "C" for Stainless Steel.

| Part Number | Thread Size | Hose Size | A | | Cutoff Allow. B | | E | | H Hex | J Hex |
|-------------|-------------|-----------|------|----|-----------------|----|------|----|-------|-------|
| | | | inch | mm | inch | mm | inch | mm | inch | inch |
| 23990-4-4 | 7/16-20 | -4 | 1.67 | 41 | 1-1/4 | 32 | 0.68 | 17 | 9/16 | 9/16 |
| 23990-5-5 | 1/2-20 | -5 | 1.75 | 44 | 1-1/4 | 32 | 0.77 | 20 | 5/8 | 5/8 |
| 23990-6-6 | 9/16-18 | -6 | 1.86 | 47 | 1-3/8 | 35 | 0.85 | 22 | 11/16 | 11/16 |
| 23990-8-6 | 3/4-16 | -6 | 1.95 | 50 | 1-7/16 | 37 | 1.09 | 28 | 11/16 | 7/8 |
| 23990-8-8 | 3/4-16 | -8 | 2.15 | 55 | 1-1/2 | 38 | 1.09 | 28 | 13/16 | 7/8 |
| 23990-10-10 | 7/8-14 | -10 | 2.38 | 60 | 1-3/4 | 44 | 1.23 | 31 | 15/16 | 1 |
| 23990-12-12 | 1-1/16-12 | -12 | 2.95 | 75 | 2-5/16 | 59 | 1.82 | 46 | 1-1/8 | 1-1/4 |
| 23990-16-16 | 1-5/16-12 | -16 | 3.13 | 80 | 2-1/2 | 64 | 2.14 | 54 | 1-3/8 | 1-1/2 |
| 23990-20-20 | 1-5/8-12 | -20 | 3.54 | 90 | 2-7/8 | 73 | 2.57 | 65 | 1-3/4 | 2 |

WARNING

This product can expose you to chemicals including Lead, which is known to the State of California to cause cancer and birth defects or other reproductive harm. For more information go to www.P65Warnings.ca.gov.

Fittings - Field Attachable

90 Series

26190 SAE Compression Air Brake

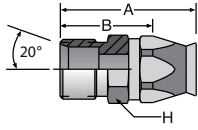

Construction: Brass nipple and ferrule, steel socket.

| Part Number | Thread Size | Hose Size | A | | Cutoff Allow. B | | H Hex |
|-------------|-------------|-----------|------|----|-----------------|----|-------|
| | | | inch | mm | inch | mm | inch |
| 26190-8-8 | 11/16-20 | -8 | 1.69 | 43 | 1-1/16 | 27 | 13/16 |
| 26190-8-10 | 11/16-20 | -10 | 1.86 | 47 | 1-3/16 | 30 | 1 |
| 26190-10-10 | 13/16-18 | -10 | 1.92 | 49 | 1-1/4 | 32 | 1 |
| 26190-12-10 | 1-18 | -10 | 2.09 | 53 | 1-7/16 | 37 | 1 |
| 26190-12-12 | 1-18 | -12 | 2.09 | 53 | 1-7/16 | 37 | 1-1/8 |

26790 SAE Male Inverted Swivel 45° Elbow

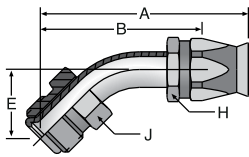

Construction: Steel nipple, nut and socket. Add "C" for Stainless Steel.

| Part Number | Thread Size | Hose Size | A | | Cutoff Allow. B | | E | | H Hex | J Hex |
|-------------|-------------|-----------|------|----|-----------------|----|------|----|-------|--------|
| | | | inch | mm | inch | mm | inch | mm | inch | inch |
| 26790-4-4 | 7/16-24 | -4 | 2.11 | 54 | 1-11/16 | 43 | 0.63 | 16 | 9/16 | 7/16 |
| 26790-5-5 | 1/2-20 | -5 | 2.51 | 64 | 2 | 51 | 0.94 | 24 | 5/8 | 1/2 |
| 26790-5-6 | 1/2-20 | -6 | 2.55 | 65 | 2-1/16 | 52 | 0.94 | 24 | 11/16 | 1/2 |
| 26790-6-6 | 5/8-18 | -6 | 2.61 | 66 | 2-1/8 | 54 | 0.94 | 24 | 11/16 | 5/8 |
| 26790-8-8 | 3/4-18 | -8 | 2.97 | 75 | 2-3/8 | 60 | 0.94 | 24 | 13/16 | 3/4 |
| 26790-8-10 | 3/4-18 | -10 | 3.05 | 77 | 2-7/16 | 62 | 0.94 | 24 | 15/16 | 3/4 |
| 26790-10-10 | 7/8-18 | -10 | 3.43 | 87 | 2-11/16 | 68 | 1.02 | 26 | 15/16 | 7/8 |
| 26790-12-12 | 1-1/16-16 | -12 | 3.83 | 97 | 3-3/16 | 81 | 1.15 | 29 | 1-1/8 | 1-1/16 |

26990 SAE Male Inverted Swivel 90° Elbow

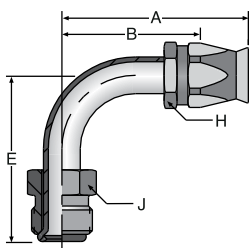

Construction: Steel nipple, nut and socket. Add "C" for Stainless Steel.

| Part Number | Thread Size | Hose Size | A | | Cutoff Allow. B | | E | | H Hex | J Hex |
|-------------|-------------|-----------|------|----|-----------------|----|------|----|-------|--------|
| | | | inch | mm | inch | mm | inch | mm | inch | inch |
| 26990-4-4 | 7/16-24 | -4 | 1.79 | 45 | 1-5/16 | 33 | 1.19 | 30 | 9/16 | 7/16 |
| 26990-5-5 | 1/2-20 | -5 | 2.01 | 51 | 1-1/2 | 38 | 1.65 | 42 | 5/8 | 1/2 |
| 26990-5-6 | 1/2-20 | -6 | 2.05 | 52 | 1-9/16 | 40 | 1.65 | 42 | 11/16 | 1/2 |
| 26990-6-6 | 5/8-18 | -6 | 2.03 | 52 | 1-1/2 | 38 | 1.70 | 43 | 11/16 | 5/8 |
| 26990-8-8 | 3/4-18 | -8 | 2.30 | 58 | 1-11/16 | 43 | 1.78 | 45 | 13/16 | 3/4 |
| 26990-8-10 | 3/4-18 | -10 | 2.39 | 61 | 1-3/4 | 44 | 1.78 | 45 | 15/16 | 3/4 |
| 26990-10-10 | 7/8-18 | -10 | 3.16 | 80 | 2-1/2 | 64 | 2.18 | 55 | 15/16 | 7/8 |
| 26990-12-12 | 1-1/16-16 | -12 | 3.56 | 90 | 2-15/16 | 75 | 2.51 | 64 | 1-1/8 | 1-1/16 |



WARNING

This product can expose you to chemicals including Lead, which is known to the State of California to cause cancer and birth defects or other reproductive harm. For more information go to www.P65Warnings.ca.gov.

Fittings - Field Attachable

90 Series

A Hose

27790 SAE 45° Swivel 45° Elbow

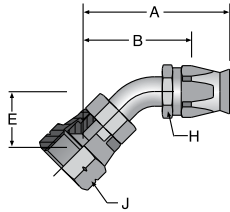

| Part Number | Thread Size | Hose Size | A | | Cutoff Allow. B | | E | | H Hex inch | J Hex inch |
|-------------|-------------|-----------|------|----|-----------------|----|------|----|------------|------------|
| | | | inch | mm | inch | mm | inch | mm | | |
| 27790-6-6 | 5/8-18 | -6 | 1.72 | 44 | 1-3/16 | 30 | 0.39 | 10 | 11/16 | 3/4 |
| 27790-12-12 | 1-1/16-14 | -12 | 3.03 | 77 | 2-3/8 | 60 | 0.78 | 20 | 1-1/8 | 1-1/4 |

Construction: Steel nipple, nut and socket. Add "C" for Stainless Steel.

B Tubing Thermoplastic

C Coiled Air Hose & Fittings

27990 SAE 45° Swivel 90° Elbow

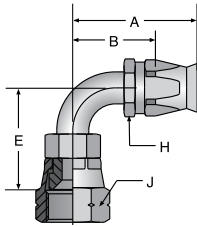

| Part Number | Thread Size | Hose Size | A | | Cutoff Allow. B | | E | | H Hex inch | J Hex inch |
|-------------|-------------|-----------|------|----|-----------------|----|------|----|------------|------------|
| | | | inch | mm | inch | mm | inch | mm | | |
| 27990-6-6 | 5/8-18 | -6 | 1.86 | 47 | 1-3/8 | 35 | .85 | 22 | 11/16 | 3/4 |
| 27990-8-8 | 3/4-16 | -8 | 2.09 | 53 | 1-1/2 | 38 | 1.09 | 28 | 13/16 | 7/8 |
| 27990-12-12 | 1-1/16-14 | -12 | 2.95 | 75 | 2-5/16 | 39 | 1.82 | 46 | 1-1/8 | 1-1/4 |

Construction: Steel nipple, nut and socket. Add "C" for Stainless Steel.

D Transportation

M Fittings

F Tooling, Equipment, & Accessories

G General Technical

WARNING

This product can expose you to chemicals including Lead, which is known to the State of California to cause cancer and birth defects or other reproductive harm. For more information go to www.P65Warnings.ca.gov.

Fittings - Field Attachable

BU Series

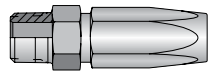
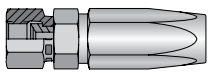
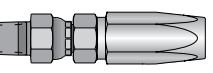
| BU Series | 201 | 206 | 213 |
|------------------|---|---|--|
| Field Attachable | Male Taper Pipe Rigid | Female SAE (JIC) 37° Swivel | Male Taper Pipe Swivel |
| |  |  |  |
| | E-31 | E-31 | E-31 |

201BU Male Taper Pipe Rigid

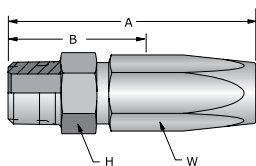

Construction: Steel.

| Part Number | Thread Size | Hose I.D. | | A | | Cutoff Allow. B | | H Hex | W Hex |
|-------------|-------------|-----------|----|------|----|-----------------|----|-------|-------|
| | | inch | mm | inch | mm | inch | mm | inch | inch |
| 201BU-2-2 | 1/8-27 | 1/8 | 3 | 1.50 | 38 | 1 | 25 | 7/16 | 7/16 |

206BU Female SAE (JIC) 37° Swivel

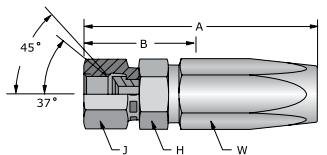

Construction: Steel.

| Part Number | Thread Size | Hose I.D. | | A | | Cutoff Allow. B | | H Hex | J Hex | W Hex |
|-------------|-------------|-----------|----|------|----|-----------------|----|-------|-------|-------|
| | | inch | mm | inch | mm | inch | mm | inch | inch | inch |
| 206BU-3-2 | 3/8-24 | 1/8 | 3 | 1.72 | 44 | 1-3/16 | 30 | 1/2 | 9/16 | 7/16 |
| 206BU-4-2 | 7/16-20 | 1/8 | 3 | 1.77 | 45 | 1-3/16 | 30 | 9/16 | 9/16 | 7/16 |

NOTE: Size -4 incorporates a dual seat.

213BU Male Taper Pipe Swivel

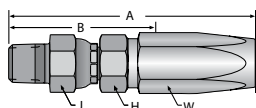

Construction: Steel.

| Part Number | Thread Size | Hose I.D. | | A | | Cutoff Allow. B | | H Hex | J Hex | W Hex |
|-------------|-------------|-----------|----|------|----|-----------------|----|-------|-------|-------|
| | | inch | mm | inch | mm | inch | mm | inch | inch | inch |
| 213BU-2-2 | 1/8-27 | 1/8 | 3 | 2.07 | 53 | 1-1/2 | 38 | 1/2 | 1/2 | 7/16 |

NOTE: Nitrile O-ring.

WARNING

This product can expose you to chemicals including Lead, which is known to the State of California to cause cancer and birth defects or other reproductive harm. For more information go to www.P65Warnings.ca.gov.

Fittings - Field Attachable

MS Series

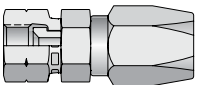
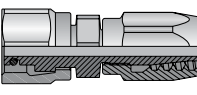
| | | | | |
|-------------------------------|---|----------------|---|-----------------------|
| MS Series Field Attachable | 208 | SAE 45° Swivel | 2TF | Marine Tube Connector |
| |  <p>E-32</p> | |  <p>E-32</p> | |

NOTE: MS Series is also available in a permanent crimp design. The fittings are listed in the Crimp Section, pg. G-6.

208MS SAE 45° Swivel (Brass)

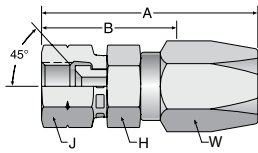

| Part Number | Thread Size | Hose I.D. | | A | | Cutoff Allow. B | | H Hex | J Hex | W Hex |
|-------------|-------------|-----------|----|------|----|-----------------|----|-------|-------|-------|
| | | inch | mm | inch | mm | inch | mm | inch | inch | inch |
| 208MS-6-5B | 5/8-18 | 5/16 | 8 | 2.06 | 52 | 1 5/16 | 33 | 13/16 | 5/8 | 5/8 |
| 208MS-6-6B | 5/8-18 | 3/8 | 10 | 2.37 | 60 | 1 7/16 | 37 | 13/16 | 5/8 | 5/8 |

Construction: Brass.

2TFMS Marine Tube Connector (Brass)

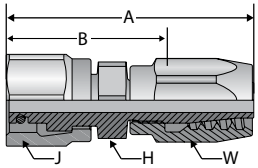

| Part Number | Thread Size | Hose I.D. | | A | | Cutoff Allow. B | | H Hex | J Hex | W Hex |
|-------------|-------------|-----------|----|------|----|-----------------|----|-------|-------|-------|
| | | inch | mm | inch | mm | inch | mm | inch | inch | inch |
| 2TFMS-6-5B | 9/16-24 | 5/16 | 8 | 2.02 | 51 | 1 5/16 | 33 | 3/4 | 5/8 | 5/8 |

NOTE: Nitrile O-ring.

Construction: Brass.







Connector Mates are manufactured by the Fluid Systems Connection Division. Refer to Catalog 3501E for more information.

WARNING

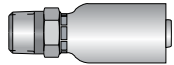
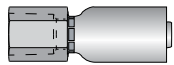
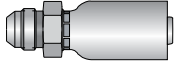
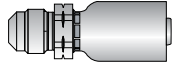
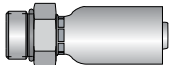
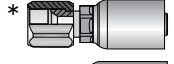
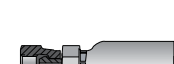
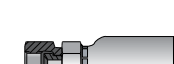
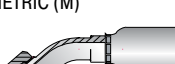
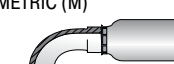
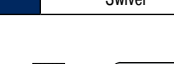
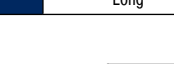
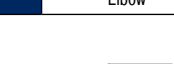
This product can expose you to chemicals including Lead, which is known to the State of California to cause cancer and birth defects or other reproductive harm. For more information go to www.P65Warnings.ca.gov.

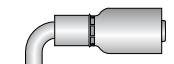
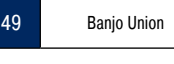
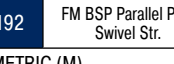
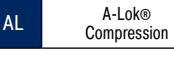
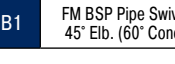
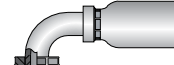
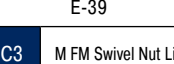
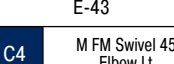
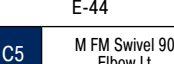
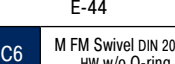
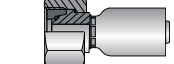
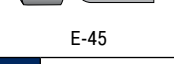
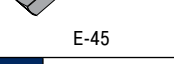
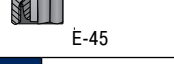
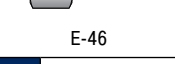
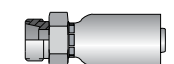
Fittings - Permanent Crimp

56 Series

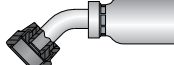
| | | | | | | | | | | |
|------------------------|---|-----------------------------|---|----------------------------------|---|------------------------------------|---|--|---|--|
| 56 Series Permanent | 101 | Male Taper Pipe Rigid | 102 | Female Taper Pipe Rigid | 103 | Male (JIC) 37° Rigid | 104 | Male SAE 45° Rigid | 105 | Male Str. Thread O-ring |
| |  | E-34 |  | E-34 |  | E-35 |  | E-35 |  | E-35 |
| | 106 | SAE (JIC) 37° Swivel | 107 | Female Pipe Swivel | 108 | Female SAE 45° Swivel | 10C | M FM Swivel 24° O-ring 45° Elb. Lt. | 11C | M FM Swivel 24° O-ring 90° Elb. Lt. |
| | *  | E-36 |  | E-36 |  | E-37 | METRIC (M)  | E-43 | METRIC (M)  | E-43 |
| | 113 | Male Pipe Swivel | 13E | Male (JIC) 37° Long | 137 | FM JIC 37° Swivel 45° Elbow | 139 | FM JIC 37° Swivel 90° Elbow | 141 | FM JIC 37° Swivel 90° Elbow-Lg |
| |  | E-37 |  | E-37 |  | E-38 |  | E-38 |  | E-39 |
| | 149 | Banjo Union | 192 | FM BSP Parallel Pipe Swivel Str. | 1AL | A-Lok® Compression | 1B1 | FM BSP Pipe Swivel 45° Elb. (60° Cone) | 1B2 | FM BSP Pipe Swivel 90° Elb. (60° Cone) |
| |  | E-39 | METRIC (M)  | E-43 |  | E-44 |  | E-44 |  | E-44 |
| | 1C3 | M FM Swivel Nut Light | 1C4 | M FM Swivel 45° Elbow Lt. | 1C5 | M FM Swivel 90° Elbow Lt. | 1C6 | M FM Swivel DIN 20078 HW w/o O-ring | 1C9 | M FM Swivel DIN 20078 HW O-ring |
| | METRIC (M)  | E-45 | METRIC (M)  | E-45 | METRIC (M)  | E-45 | METRIC (M)  | E-46 | METRIC (M)  | E-46 |
| | 1CA | M FM Swivel 24° Lt. O-ring | 1CE | M FM Swivel 24° O-ring 45° Elb. | 1CF | M FM Swivel 24° O-ring 90° Elb. | 1D0 | M Male Stud DIN 20078 Lt. | 1D2 | M Male Stud 24° Heavy |
| | METRIC (M)  | E-47 | METRIC (M)  | E-47 | METRIC (M)  | E-48 | METRIC (M)  | E-49 | METRIC (M)  | E-49 |
| | 1D9 | Male BSPP - Str. (60° Cone) | 1FU | JIS/BSP 30° Flare Swivel Female | 1J0 | Male Seal-Lok™ Rigid Str. w/O-ring | 1J1 | Female Seal-Lok™ 90° Elbow Long | 1J2 | Female Seal-Lok™ 30° Elbow |
| |  | E-49 |  | E-48 |  | E-40 |  | E-40 |  | E-41 |

***ToughShield Plus** ToughShield Plus, featuring Parker's Zinc Nickel Plating Standard, protects against corrosion, improving the performance of crimp hose fittings in harsh hydraulic environments, reducing both downtime and warranty costs.

WARNING

This product can expose you to chemicals including Lead, which is known to the State of California to cause cancer and birth defects or other reproductive harm. For more information go to www.P65Warnings.ca.gov.

Fittings - Permanent Crimp

56 Series

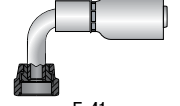
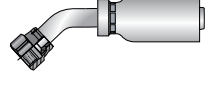
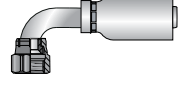
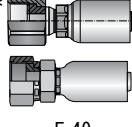
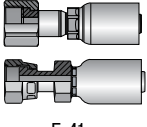
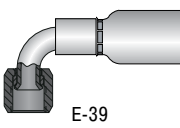
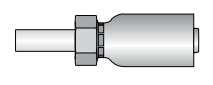
| | | | | | | | | | | |
|------------------------|---|---------------------------------------|---|-----------------------------------|---|---------------------------------------|---|------------------------------------|---|---------------------------|
| 56 Series Permanent | 1J5 | Female Seal-Lok™ Swivel 90° Elb. Med. | 1J7 | Female Seal-Lok™ Swivel 45° Elbow | 1J9 | Female Seal-Lok™ Swivel 90° Elb Short | 1JC | Female Seal-Lok™ Str. Swivel Short | 1JS | Female Seal-Lok™ Straight |
| |  | |  | |  | |  | |  | |
| | 1L9 | Female JIC 37° Swivel 90° Elb. Med. | 1TU | Universal Inch Tube Stub End | | | | | | |
| |  | |  | | | | | | | |

*ToughShield Plus

ToughShield Plus, featuring Parker's Zinc Nickel Plating Standard, protects against corrosion, improving the performance of crimp hose fittings in harsh hydraulic environments, reducing both downtime and warranty costs.

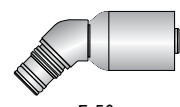
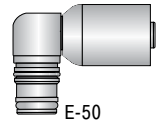
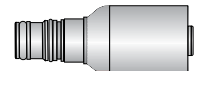
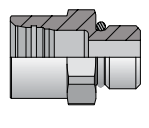
| | | | | | | | | |
|--|---|-------------------------------|---|-------------------------------|---|-------------------------------|---|-------------------------------------|
| 56 Series Permanent RAPID ASSEMBLY | 1WW | Male Rapid Assembly, 45° Elb. | 1WY | Male Rapid Assembly, 90° Elb. | 1WU | Male Rapid Assembly, Straight | 685RA | Female Rapid Assy. Adapter Male SAE |
| |  | |  | |  | |  | |

10156 Male Taper Pipe Rigid

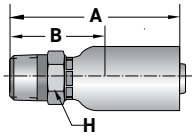

Construction: Steel. Add "C" for Stainless Steel.

| Part Number | Thread Size | Hose I.D. | | A | | Cutoff Allow. B | | H Hex inch |
|-------------|-------------|-----------|----|------|----|-----------------|----|------------|
| | | inch | mm | inch | mm | inch | mm | |
| 10156-2-2 | 1/8-27 | 1/8 | 3 | 1.35 | 34 | 3/4 | 19 | 1/2 |
| 10156-2-3 | 1/8-27 | 3/16 | 5 | 1.60 | 41 | 7/8 | 22 | 9/16 |
| 10156-4-2 | 1/4-18 | 1/8 | 3 | 1.56 | 40 | 15/16 | 24 | 5/8 |
| 10156-4-3 | 1/4-18 | 3/16 | 5 | 1.82 | 46 | 1-1/8 | 28 | 9/16 |
| 10156-4-4 | 1/4-18 | 1/4 | 6 | 2.09 | 53 | 1-1/8 | 28 | 9/16 |
| 10156-4-6 | 1/4-18 | 3/8 | 10 | 2.16 | 55 | 1-3/16 | 30 | 11/16 |
| 10156-6-6 | 3/8-18 | 3/8 | 10 | 2.16 | 55 | 1-3/16 | 30 | 3/4 |
| 10156-8-8 | 1/2-14 | 1/2 | 13 | 2.55 | 65 | 1-7/16 | 37 | 7/8 |
| 10156-12-10 | 3/4-14 | 5/8 | 16 | 2.88 | 73 | 1-9/16 | 40 | 1-1/8 |
| 10156-12-12 | 3/4-14 | 3/4 | 19 | 2.97 | 75 | 1-5/8 | 41 | 1-1/16 |
| 10156-16-16 | 1-11-1/2 | 1 | 25 | 3.76 | 96 | 1-7/8 | 48 | 1-3/8 |

10256 Female Taper Pipe Rigid

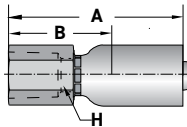

Construction: Steel. Add "C" for Stainless Steel.

| Part Number | Thread Size | Hose I.D. | | A | | Cutoff Allow. B | | H Hex inch |
|-------------|-------------|-----------|----|------|----|-----------------|----|------------|
| | | inch | mm | inch | mm | inch | mm | |
| 10256-4-4 | 1/4-18 | 1/4 | 6 | 1.99 | 51 | 1 | 25 | 11/16 |

WARNING

This product can expose you to chemicals including Lead, which is known to the State of California to cause cancer and birth defects or other reproductive harm. For more information go to www.P65Warnings.ca.gov.

Fittings - Permanent Crimp

56 Series

10356 Male (JIC) 37° Rigid

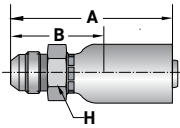

Construction: Steel. Add "C" for Stainless Steel.

| Part Number | Thread Size | Hose I.D. | | A | | Cutoff Allow. B | | H Hex inch |
|-------------|-------------|-----------|----|------|----|-----------------|----|------------|
| | | inch | mm | inch | mm | inch | mm | |
| 10356-4-3 | 7/16-20 | 3/16 | 5 | 1.83 | 46 | 1-1/8 | 28 | 9/16 |
| 10356-4-4 | 7/16-20 | 1/4 | 6 | 2.10 | 53 | 1-1/8 | 28 | 9/16 |
| 10356-5-4 | 1/2-20 | 1/4 | 6 | 2.10 | 53 | 1-1/8 | 28 | 9/16 |
| 10356-6-4 | 9/16-18 | 1/4 | 6 | 2.14 | 54 | 1-3/16 | 30 | 11/16 |
| 10356-6-5 | 9/16-18 | 5/16 | 8 | 2.22 | 56 | 1-3/16 | 30 | 11/16 |
| 10356-5-6 | 1/2-20 | 3/8 | 10 | 2.14 | 54 | 1-1/8 | 28 | 5/8 |
| 10356-6-6 | 9/16-18 | 3/8 | 10 | 2.15 | 55 | 1-3/16 | 30 | 5/8 |
| 10356-8-6 | 3/4-16 | 3/8 | 10 | 2.25 | 57 | 1-1/4 | 32 | 13/16 |
| 10356-8-8 | 3/4-16 | 1/2 | 13 | 2.40 | 61 | 1-5/16 | 33 | 7/8 |
| 10356-10-8 | 7/8-14 | 1/2 | 13 | 2.60 | 66 | 1-1/2 | 38 | 15/16 |
| 10356-12-10 | 1-1/16-12 | 5/8 | 16 | 2.97 | 75 | 1-5/8 | 42 | 1-1/8 |
| 10356-12-12 | 1-1/16-12 | 3/4 | 19 | 3.07 | 78 | 1-3/4 | 44 | 1-1/8 |
| 10356-16-16 | 1-5/16-12 | 1 | 25 | 3.66 | 93 | 1-3/4 | 44 | 1-3/8 |

10456 Male SAE 45° Rigid

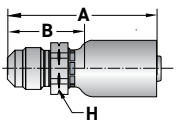

Construction: Steel. Add "C" for Stainless Steel.

| Part Number | Thread Size | Hose I.D. | | A | | Cutoff Allow. B | | H Hex inch |
|-------------|-------------|-----------|----|------|----|-----------------|----|------------|
| | | inch | mm | inch | mm | inch | mm | |
| 10456-4-3 | 7/16-20 | 3/16 | 5 | 1.71 | 43 | 1 | 25 | 9/16 |
| 10456-5-4 | 1/2-20 | 1/4 | 6 | 2.11 | 54 | 1-1/8 | 28 | 9/16 |
| 10456-6-5 | 5/8-18 | 5/16 | 8 | 2.18 | 55 | 1-3/16 | 30 | 11/16 |
| 10456-6-6 | 5/8-18 | 1/2 | 13 | 2.16 | 55 | 1-3/16 | 30 | 11/16 |
| 10456-6-8 | 5/8-18 | 1/2 | 13 | 2.37 | 60 | 1-1/4 | 32 | 3/4 |
| 10456-8-8 | 3/4-16 | 1/2 | 13 | 0.25 | 64 | 1-3/8 | 35 | 7/8 |
| 10456-12-12 | 1-1/16-14 | 3/4 | 19 | 3.11 | 79 | 1-3/4 | 44 | 1-1/8 |

10556 Male Straight Thread O-ring (Nitrile O-ring included)

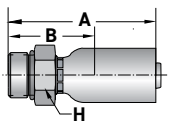

Construction: Steel. Add "C" for Stainless Steel.

| Part Number | Thread Size | Hose I.D. | | A | | Cutoff Allow. B | | H Hex inch |
|-------------|-------------|-----------|----|------|----|-----------------|----|------------|
| | | inch | mm | inch | mm | inch | mm | |
| 10556-4-3 | 7/16-20 | 3/16 | 4 | 1.61 | 41 | 15/16 | 24 | 9/16 |
| 10556-6-3 | 9/16-18 | 3/16 | 4 | 1.64 | 42 | 15/16 | 24 | 11/16 |
| 10556-4-4 | 7/16-20 | 1/4 | 6 | 1.84 | 47 | 7/8 | 22 | 9/16 |
| 10556-5-4 | 1/2-20 | 1/4 | 6 | 1.84 | 47 | 7/8 | 22 | 5/8 |
| 10556-6-4 | 9/16-18 | 1/4 | 6 | 1.91 | 49 | 15/16 | 24 | 11/16 |
| 10556-4-5 | 7/16-20 | 5/16 | 8 | 1.91 | 49 | 7/8 | 22 | 5/8 |
| 10556-5-5 | 1/2-20 | 5/16 | 8 | 1.91 | 49 | 7/8 | 22 | 5/8 |
| 10556-6-6 | 9/16-18 | 3/8 | 10 | 1.95 | 50 | 15/16 | 24 | 11/16 |
| 10556-8-6 | 3/4-16 | 3/8 | 10 | 1.98 | 50 | 1 | 25 | 7/8 |
| 10556-8-8 | 3/4-16 | 1/2 | 12 | 2.21 | 56 | 1-1/8 | 28 | 7/8 |
| 10556-10-8 | 7/8-14 | 1/2 | 12 | 2.28 | 58 | 1-3/16 | 30 | 1 |

NOTE: Nitrile O-ring.

WARNING

This product can expose you to chemicals including Lead, which is known to the State of California to cause cancer and birth defects or other reproductive harm. For more information go to www.P65Warnings.ca.gov.

Fittings - Permanent Crimp

56 Series

10656 SAE (JIC) 37° Swivel

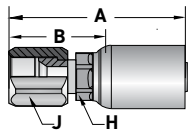

ToughShield Plus

*Construction: Steel

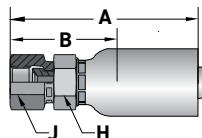

Construction: Steel. Add "C" for Stainless Steel.

| Part Number | Thread Size | Hose I.D. | | A | | Cutoff Allow. B | | H Hex inch | J Hex inch |
|-------------|-------------|-----------|----|------|-----|-----------------|----|------------|------------|
| | | inch | mm | inch | mm | inch | mm | | |
| 10656-2-2 | 5/16-24 | 1/8 | 3 | 1.63 | 41 | 1 | 25 | 1/2 | 1/2 |
| 10656-3-2 | 3/8-24 | 1/8 | 3 | 1.60 | 41 | 15/16 | 24 | 1/2 | 9/16 |
| 10656-4-2 | 7/16-20 | 1/8 | 3 | 1.68 | 43 | 1-1/16 | 27 | 1/2 | 5/8 |
| 10656-3-3 | 3/8-24 | 3/16 | 5 | 1.91 | 49 | 1-3/16 | 30 | 1/2 | 1/2 |
| 10656-4-3 | 7/16-20 | 3/16 | 5 | 1.78 | 45 | 1-1/16 | 27 | 9/16 | 9/16 |
| 10656-5-3 | 1/2-20 | 3/16 | 5 | 1.84 | 47 | 1-1/8 | 28 | 9/16 | 5/8 |
| 10656-2-4 | 3/8-24 | 1/4 | 6 | 1.98 | 50 | 1 | 25 | 1/2 | 7/16 |
| 10656-4-4* | 7/16-20 | 1/4 | 6 | 2.05 | 52 | 1-1/16 | 27 | 7/16 | 9/16 |
| 10656-4-4C | 7/16-20 | 1/4 | 6 | 2.05 | 52 | 1-1/16 | 27 | 9/16 | 9/16 |
| 10656-5-4 | 1/2-20 | 1/4 | 6 | 2.12 | 54 | 1-1/8 | 28 | 9/16 | 5/8 |
| 10656-6-4 | 9/16-18 | 1/4 | 6 | 2.14 | 54 | 1-3/16 | 30 | 9/16 | 11/16 |
| 10656-4-5 | 7/16-20 | 5/16 | 8 | 2.10 | 53 | 1-1/16 | 27 | 9/16 | 9/16 |
| 10656-5-5 | 1/2-20 | 5/16 | 8 | 2.21 | 56 | 1-3/16 | 30 | 5/8 | 5/8 |
| 10656-6-5 | 9/16-18 | 5/16 | 8 | 2.23 | 57 | 1-3/16 | 30 | 5/8 | 11/16 |
| 10656-4-6 | 7/16-20 | 3/8 | 10 | 2.09 | 53 | 1-1/8 | 28 | 9/16 | 9/16 |
| 10656-5-6 | 1/2-20 | 3/8 | 10 | 2.23 | 57 | 1-1/4 | 32 | 5/8 | 5/8 |
| 10656-6-6* | 9/16-18 | 3/8 | 10 | 2.22 | 56 | 1-1/4 | 32 | 9/16 | 11/16 |
| 10656-6-6C | 9/16-18 | 3/8 | 10 | 2.22 | 56 | 1-1/4 | 32 | 11/16 | 11/16 |
| 10656-8-6* | 3/4-16 | 3/8 | 10 | 2.37 | 60 | 1-3/8 | 35 | 9/16 | 7/8 |
| 10656-8-6C | 3/4-16 | 3/8 | 10 | 2.37 | 60 | 1-3/8 | 35 | 11/16 | 7/8 |
| 10656-6-8 | 9/16-18 | 1/2 | 13 | 2.42 | 61 | 1-5/16 | 33 | 3/4 | 11/16 |
| 10656-8-8* | 3/4-16 | 1/2 | 13 | 2.54 | 64 | 1-7/16 | 36 | 11/16 | 7/8 |
| 10656-8-8C | 3/4-16 | 1/2 | 13 | 2.54 | 64 | 1-7/16 | 36 | 13/16 | 7/8 |
| 10656-10-8 | 7/8-14 | 1/2 | 13 | 2.64 | 67 | 1-1/2 | 38 | 7/8 | 1 |
| 10656-8-10 | 3/4-16 | 5/8 | 16 | 2.73 | 69 | 1-7/16 | 36 | 15/16 | 7/8 |
| 10656-10-10 | 7/8-14 | 5/8 | 16 | 2.99 | 76 | 1-11/16 | 43 | 15/16 | 1 |
| 10656-12-10 | 1-1/16-12 | 5/8 | 16 | 3.06 | 78 | 1-3/4 | 44 | 1-1/16 | 1-1/4 |
| 10656-10-12 | 7/8-14 | 3/4 | 19 | 2.88 | 73 | 1-1/2 | 38 | 1-1/16 | 1 |
| 10656-12-12 | 1-1/16-12 | 3/4 | 19 | 3.06 | 78 | 1-3/4 | 44 | 1-1/16 | 1-1/4 |
| 10656-16-12 | 1-5/16-12 | 3/4 | 19 | 3.27 | 83 | 1-15/16 | 49 | 1-1/4 | 1-1/2 |
| 10656-16-16 | 1-5/16-12 | 1 | 25 | 3.81 | 97 | 1-15/16 | 49 | 1-3/8 | 1-1/2 |
| 10656-20-16 | 1-5/8-12 | 1 | 25 | 3.96 | 101 | 2-1/16 | 52 | 1-5/8 | 2 |

10756 Female Pipe Swivel

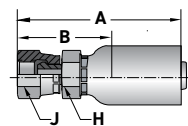

Construction: Steel. Add "C" for Stainless Steel.

| Part Number | Thread Size | Hose I.D. | | A | | Cutoff Allow. B | | H Hex inch | J Hex inch |
|-------------|-------------|-----------|----|------|----|-----------------|----|------------|------------|
| | | inch | mm | inch | mm | inch | mm | | |
| 10756-4-4 | 1/4-18 | 1/4 | 6 | 2.03 | 52 | 1-1/16 | 27 | 9/16 | 11/16 |
| 10756-4-5 | 1/4-18 | 5/16 | 8 | 2.09 | 53 | 1-1/16 | 27 | 9/16 | 11/16 |
| 10756-6-6 | 3/8-18 | 3/8 | 10 | 2.13 | 54 | 1-1/8 | 28 | 11/16 | 7/8 |
| 10756-8-8 | 1/2-14 | 1/2 | 13 | 2.40 | 61 | 1-5/16 | 33 | 7/8 | 1 |
| 10756-12-12 | 3/4-14 | 3/4 | 19 | 2.98 | 76 | 1-5/8 | 41 | 1-1/16 | 1-1/4 |
| 10756-16-16 | 1-11-1/2 | 1 | 25 | 3.74 | 95 | 1-7/8 | 48 | 1-3/8 | 1-1/2 |

WARNING

This product can expose you to chemicals including Lead, which is known to the State of California to cause cancer and birth defects or other reproductive harm. For more information go to www.P65Warnings.ca.gov.

Fittings - Permanent Crimp

56 Series

10856 Female SAE 45° Swivel

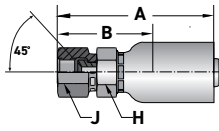

Construction: Steel. Add "C" for Stainless Steel.

| Part Number | Thread Size | Hose I.D. | | A | | Cutoff Allow. B | | H Hex inch | J Hex inch |
|-------------|-------------|-----------|----|------|----|-----------------|----|------------|------------|
| | | inch | mm | inch | mm | inch | mm | | |
| 10856-6-4 | 5/8-18 | 1/4 | 6 | 2.19 | 56 | 1-1/4 | 32 | 11/16 | 3/4 |
| 10856-6-5 | 5/8-18 | 5/16 | 8 | 2.28 | 58 | 1-1/4 | 32 | 11/16 | 3/4 |
| 10856-6-6 | 5/8-18 | 3/8 | 10 | 2.36 | 60 | 1-3/8 | 35 | 11/16 | 3/4 |
| 10856-12-12 | 1-1/16-14 | 3/4 | 19 | 3.06 | 78 | 1-3/4 | 44 | 1-1/16 | 1-1/4 |

11356 Male Pipe Swivel

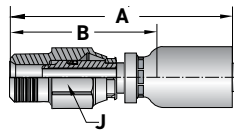

Construction: Steel. Add "C" for Stainless Steel.

| Part Number | Thread Size | Hose I.D. | | A | | Cutoff Allow. B | | J Hex inch |
|-------------|-------------|-----------|----|------|-----|-----------------|----|------------|
| | | inch | mm | inch | mm | inch | mm | |
| 11356-2-2 | 1/8-27 | 1/8 | 3 | 1.96 | 50 | 1-5/16 | 33 | 1/2 |
| 11356-2-3 | 1/8-27 | 3/16 | 5 | 2.17 | 73 | 1-1/2 | 54 | 5/8 |
| 11356-4-3 | 1/4-18 | 3/16 | 5 | 2.59 | 66 | 1-7/8 | 48 | 5/8 |
| 11356-4-4 | 1/4-18 | 1/4 | 6 | 2.95 | 75 | 2 | 50 | 5/8 |
| 11356-4-5 | 1/4-18 | 5/16 | 8 | 2.77 | 75 | 1-3/4 | 49 | 5/8 |
| 11356-6-6 | 3/8-18 | 3/8 | 10 | 3.06 | 78 | 2-1/16 | 52 | 3/4 |
| 11356-8-6 | 1/2-14 | 3/8 | 10 | 3.24 | 82 | 2-1/4 | 57 | 15/16 |
| 11356-8-8 | 1/2-14 | 1/2 | 13 | 3.37 | 86 | 2-1/4 | 57 | 15/16 |
| 11356-12-12 | 3/4-14 | 3/4 | 19 | 3.71 | 94 | 2-3/8 | 60 | 1-1/4 |
| 11356-16-16 | 1-11-1/2 | 1 | 25 | 4.35 | 118 | 2-7/16 | 70 | 1-1/2 |

NOTE: Nitrile O-ring.

13E56 Male (JIC) 37° Long

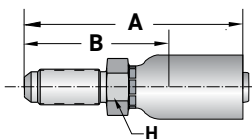

Construction: Steel. Add "C" for Stainless Steel.

| Part Number | Thread Size | Hose I.D. | | A | | Cutoff Allow. B | | H Hex inch |
|-------------|-------------|-----------|----|------|----|-----------------|----|------------|
| | | inch | mm | inch | mm | inch | mm | |
| 13E56-4-4 | 7/16-20 | 1/4 | 6 | 2.80 | 71 | 1-13/16 | 46 | 5/8 |
| 13E56-6-5 | 9/16-18 | 5/16 | 8 | 2.97 | 75 | 1-15/16 | 49 | 3/4 |
| 13E56-6-6 | 9/16-18 | 3/8 | 10 | 2.97 | 75 | 2 | 50 | 7/8 |
| 13E56-8-8 | 3/4-16 | 1/2 | 13 | 3.24 | 82 | 2-1/8 | 54 | 7/8 |

NOTE: Bulkhead Locknut sold separately. WLN Locknuts are manufactured by the Tube Fittings Division. Refer to Catalog 4300 for additional information.

WARNING

This product can expose you to chemicals including Lead, which is known to the State of California to cause cancer and birth defects or other reproductive harm. For more information go to www.P65Warnings.ca.gov.

Fittings - Permanent Crimp

56 Series

13756 Female JIC 37° Swivel 45° Elbow

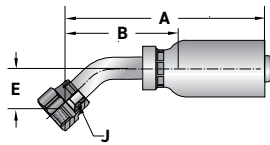

Construction: Steel. Add "C" for Stainless Steel.

| Part Number | Thread Size | Hose I.D. | | A | | Cutoff Allow. B | | E | | J Hex |
|-------------|-------------|-----------|----|------|-----|-----------------|----|------|----|-------|
| | | inch | mm | inch | mm | inch | mm | inch | mm | inch |
| 13756-4-2 | 7/16-20 | 1/8 | 3 | 1.98 | 50 | 1-5/16 | 33 | .33 | 8 | 9/16 |
| 13756-4-3 | 7/16-20 | 3/16 | 5 | 1.93 | 49 | 1-1/4 | 32 | .39 | 10 | 9/16 |
| 13756-4-4 | 7/16-20 | 1/4 | 6 | 2.19 | 56 | 1-1/4 | 32 | .39 | 10 | 9/16 |
| 13756-5-4 | 1/2-20 | 1/4 | 6 | 2.46 | 62 | 1-1/2 | 38 | .39 | 10 | 5/8 |
| 13756-6-4 | 9/16-18 | 1/4 | 6 | 2.24 | 57 | 1-1/4 | 32 | .43 | 11 | 11/16 |
| 13756-6-5 | 9/16-18 | 5/16 | 8 | 2.53 | 64 | 1-1/2 | 38 | .43 | 11 | 11/16 |
| 13756-6-6 | 9/16-18 | 3/8 | 10 | 2.57 | 65 | 1-9/16 | 40 | .43 | 11 | 11/16 |
| 13756-8-6 | 3/4-16 | 3/8 | 10 | 2.76 | 70 | 1-3/4 | 44 | .59 | 15 | 7/8 |
| 13756-8-8 | 3/4-16 | 1/2 | 13 | 2.72 | 69 | 1-5/8 | 41 | .59 | 15 | 7/8 |
| 13756-10-8 | 7/8-14 | 1/2 | 13 | 2.87 | 73 | 1-3/4 | 45 | .63 | 16 | 1 |
| 13756-10-10 | 7/8-14 | 5/8 | 16 | 3.23 | 83 | 2 | 50 | .63 | 16 | 1 |
| 13756-12-10 | 1-1/16-12 | 5/8 | 16 | 3.74 | 95 | 2.40 | 61 | .83 | 21 | 1-1/4 |
| 13756-12-12 | 1-1/16-12 | 3/4 | 19 | 4.03 | 102 | 2-11/16 | 68 | .83 | 21 | 1-1/4 |
| 13756-16-16 | 1-5/16-12 | 1 | 25 | 4.53 | 115 | 2.63 | 67 | .94 | 24 | 1-1/2 |

13956 Female JIC 37° Swivel 90° Elbow

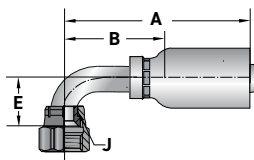

Construction: Steel. Add "C" for Stainless Steel.

| Part Number | Thread Size | Hose I.D. | | A | | Cutoff Allow. B | | E | | J Hex |
|-------------|-------------|-----------|----|------|-----|-----------------|----|------|----|-------|
| | | inch | mm | inch | mm | inch | mm | inch | mm | inch |
| 13956-4-2 | 7/16-20 | 1/8 | 3 | 1.83 | 46 | 1-1/4 | 32 | .68 | 17 | 9/16 |
| 13956-4-3 | 7/16-20 | 3/16 | 5 | 1.75 | 44 | 1-1/16 | 27 | .83 | 21 | 9/16 |
| 13956-4-4 | 7/16-20 | 1/4 | 6 | 2.01 | 51 | 1-1/16 | 27 | .83 | 21 | 9/16 |
| 13956-5-4 | 1/2-20 | 1/4 | 6 | 2.01 | 51 | 1-1/16 | 27 | .83 | 21 | 5/8 |
| 13956-6-4 | 9/16-18 | 1/4 | 6 | 2.01 | 51 | 1-1/16 | 27 | .91 | 23 | 11/16 |
| 13956-6-5 | 9/16-18 | 5/16 | 8 | 2.14 | 54 | 1-1/8 | 28 | .91 | 23 | 11/16 |
| 13956-6-6 | 9/16-18 | 3/8 | 10 | 2.22 | 56 | 1-1/4 | 32 | .91 | 23 | 11/16 |
| 13956-8-6 | 3/4-16 | 3/8 | 10 | 2.55 | 65 | 1-9/16 | 40 | 1.14 | 29 | 7/8 |
| 13956-8-8 | 3/4-16 | 1/2 | 13 | 2.48 | 63 | 1-3/8 | 35 | 1.14 | 29 | 7/8 |
| 13956-10-8 | 7/8-14 | 1/2 | 13 | 2.60 | 66 | 1-1/2 | 38 | 1.26 | 32 | 1 |
| 13956-10-10 | 7/8-14 | 5/8 | 16 | 2.96 | 75 | 1-5/8 | 41 | 1.26 | 32 | 1 |
| 13956-12-10 | 1-1/16-12 | 5/8 | 19 | 3.39 | 86 | 2-1/16 | 52 | 1.89 | 48 | 1-1/4 |
| 13956-12-12 | 1-1/16-12 | 3/4 | 19 | 3.89 | 99 | 2-9/16 | 65 | 1.89 | 48 | 1-1/4 |
| 13956-16-16 | 1-5/16-12 | 1 | 25 | 4.50 | 114 | 2.60 | 66 | 2.20 | 56 | 1-1/2 |

WARNING

This product can expose you to chemicals including Lead, which is known to the State of California to cause cancer and birth defects or other reproductive harm. For more information go to www.P65Warnings.ca.gov.

Fittings - Permanent Crimp

56 Series

14156 Female JIC 37° Swivel 90° Elbow Long Drop

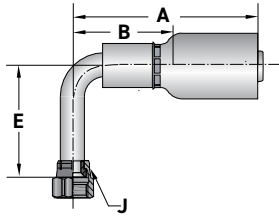

Construction: Steel. Add "C" for Stainless Steel.

| Part Number | Thread Size | Hose I.D. | | A | | Cutoff Allow. B | | E | | J Hex inch |
|-------------|-------------|-----------|----|------|-----|-----------------|----|------|-----|------------|
| | | inch | mm | inch | mm | inch | mm | inch | mm | |
| 14156-4-3 | 7/16-20 | 3/16 | 5 | 2.00 | 51 | 1-5/16 | 33 | 1.81 | 46 | 9/16 |
| 14156-4-4 | 7/16-20 | 1/4 | 6 | 2.31 | 59 | 1-3/8 | 35 | 1.81 | 46 | 9/16 |
| 14156-5-4 | 1/2-20 | 1/4 | 6 | 2.34 | 60 | 1-3/8 | 35 | 1.81 | 46 | 5/8 |
| 14156-6-4 | 9/16-18 | 1/4 | 6 | 2.39 | 61 | 1-7/16 | 36 | 2.13 | 54 | 11/16 |
| 14156-6-5 | 9/16-18 | 5/16 | 8 | 2.36 | 60 | 1-5/16 | 33 | 2.13 | 54 | 11/16 |
| 14156-6-6 | 9/16-18 | 3/8 | 10 | 2.39 | 61 | 1-3/8 | 35 | 2.13 | 54 | 11/16 |
| 14156-8-6 | 3/4-16 | 3/8 | 10 | 2.49 | 63 | 1-1/2 | 38 | 2.52 | 64 | 7/8 |
| 14156-8-8 | 3/4-16 | 1/2 | 13 | 2.61 | 66 | 1-1/2 | 38 | 2.52 | 64 | 7/8 |
| 14156-10-8 | 7/8-14 | 1/2 | 13 | 2.48 | 63 | 1-3/8 | 35 | 2.76 | 70 | 1 |
| 14156-12-12 | 1-1/16-12 | 3/4 | 19 | 3.59 | 91 | 2-1/4 | 57 | 3.78 | 96 | 1-1/4 |
| 14156-16-16 | 1-5/16-12 | 1 | 25 | 4.36 | 111 | 2-1/2 | 63 | 4.49 | 114 | 1-1/2 |

1L956 Female JIC 37° Swivel 90° Elbow Medium Drop

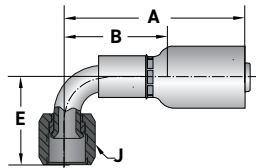

Construction: Steel. Add "C" for Stainless Steel.

| Part Number | Thread Size | Hose I.D. | | A | | Cutoff Allow. B | | E | | J Hex inch |
|-------------|-------------|-----------|----|------|-----|-----------------|----|------|----|------------|
| | | inch | mm | inch | mm | inch | mm | inch | mm | |
| 1L956-4-3 | 7/16-20 | 3/16 | 5 | 1.97 | 50 | 1-1/4 | 32 | 1.26 | 32 | 9/16 |
| 1L956-4-4 | 7/16-20 | 1/4 | 6 | 2.29 | 58 | 1-5/16 | 34 | 1.26 | 32 | 9/16 |
| 1L956-5-4 | 1/2-20 | 1/4 | 6 | 2.31 | 59 | 1-3/8 | 35 | 1.26 | 32 | 5/8 |
| 1L956-6-5 | 9/16-18 | 5/16 | 8 | 2.33 | 59 | 1-5/16 | 34 | 1.50 | 38 | 11/16 |
| 1L956-6-6 | 9/16-18 | 3/8 | 10 | 2.36 | 60 | 1-1/4 | 31 | 1.50 | 38 | 11/16 |
| 1L956-8-6 | 3/4-16 | 3/8 | 10 | 2.44 | 62 | 1-7/16 | 37 | 1.61 | 41 | 7/8 |
| 1L956-8-8 | 3/4-16 | 1/2 | 13 | 2.57 | 65 | 1-7/16 | 37 | 1.61 | 41 | 7/8 |
| 1L956-10-8 | 7/8-14 | 1/2 | 13 | 2.48 | 63 | 1-3/8 | 35 | 1.85 | 47 | 1 |
| 1L956-12-12 | 1-1/16-12 | 3/4 | 19 | 3.89 | 99 | 2-9/16 | 65 | 2.28 | 58 | 1-1/4 |
| 1L956-16-16 | 1-5/16-12 | 1 | 25 | 4.36 | 111 | 2-1/2 | 63 | 2.80 | 71 | 1-1/2 |

14956 – Banjo Union DIN7642

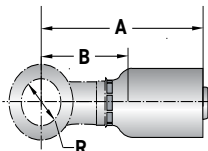

Construction: Steel.

| Part Number | Diameter R | Hose I.D. | | A | | Cutoff Allow. B | |
|-------------|------------|-----------|------|----|------|-----------------|------|
| | | mm | inch | mm | inch | mm | inch |
| 14956-14-3 | 14 | 5 | 3/16 | 49 | 1.93 | 31 | 1.22 |
| 14956-12-4 | 12 | 6 | 1/4 | 50 | 1.97 | 25 | 1.5 |
| 14956-14-4 | 14 | 6 | 1/4 | 56 | 2.2 | 32 | 1.26 |
| 14956-12-5 | 12 | 8 | 5/16 | 54 | 2.13 | 29 | 1.14 |
| 14956-14-5 | 14 | 8 | 5/16 | 53 | 2.09 | 27 | 1.06 |
| 14956-17-6 | 17 | 10 | 3/8 | 55 | 2.17 | 29 | 1.14 |

1J056 Male Seal-Lok™ Rigid Straight w/O-ring ISO 12151-1-S

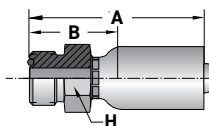

Construction: Steel. Add "C" for Stainless Steel.

| Part Number | Thread Size | Hose I.D. | | A | | Cutoff Allow. B | | H Hex inch |
|-------------|-------------|-----------|----|------|----|-----------------|----|------------|
| | | inch | mm | inch | mm | inch | mm | |
| 1J056-4-4 | 9/16-18 | 1/4 | 6 | 1.93 | 49 | 15/16 | 24 | 5/8 |
| 1J056-6-4 | 11/16-16 | 1/4 | 6 | 2.01 | 51 | 1-1/16 | 27 | 3/4 |
| 1J056-6-6 | 11/16-16 | 3/8 | 10 | 1.98 | 50 | 1 | 25 | 3/4 |
| 1J056-8-6 | 13/16-16 | 1/2 | 13 | 2.16 | 55 | 1-3/16 | 30 | 7/8 |
| 1J056-8-8 | 13/16-16 | 1/2 | 13 | 2.18 | 55 | 1-1/16 | 27 | 7/8 |

NOTE: Nitrile O-ring.

WARNING

This product can expose you to chemicals including Lead, which is known to the State of California to cause cancer and birth defects or other reproductive harm. For more information go to www.P65Warnings.ca.gov.

Fittings - Permanent Crimp

56 Series

1J156 Female Seal-Lok™ Swivel 90° Elbow Long Drop ISO 12151-1-SWEL90

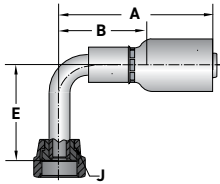

Construction: Steel. Add "C" for Stainless Steel.

| Part Number | Thread Size | Hose I.D. | | A | | Cutoff Allow. B | | E | | J Hex |
|-------------|-------------|-----------|----|------|-----|-----------------|----|------|-----|-------|
| | | inch | mm | inch | mm | inch | mm | inch | mm | inch |
| 1J156-4-3 | 9/16-18 | 3/16 | 5 | 2.05 | 52 | 1-3/8 | 35 | 1.81 | 46 | 11/16 |
| 1J156-4-4 | 9/16-18 | 1/4 | 6 | 2.37 | 60 | 1-3/8 | 35 | 1.81 | 46 | 11/16 |
| 1J156-6-4 | 11/16-16 | 1/4 | 6 | 2.45 | 62 | 1-1/2 | 38 | 2.13 | 54 | 13/16 |
| 1J156-6-6 | 11/16-16 | 3/8 | 10 | 2.45 | 62 | 1-7/16 | 37 | 2.13 | 54 | 13/16 |
| 1J156-8-6 | 13/16-16 | 3/8 | 10 | 2.53 | 64 | 1-7/16 | 37 | 2.52 | 64 | 15/16 |
| 1J156-8-8 | 13/16-16 | 1/2 | 13 | 2.67 | 68 | 1-9/16 | 40 | 2.52 | 64 | 15/16 |
| 1J156-12-12 | 1-3/16-12 | 3/4 | 19 | 3.59 | 91 | 2-1/4 | 57 | 3.78 | 96 | 1-3/8 |
| 1J156-16-16 | 1-7/16-12 | 1 | 25 | 4.36 | 111 | 2-1/2 | 63 | 4.49 | 114 | 1-5/8 |

1JC56 Female Seal-Lok™ Straight Swivel Short ISO 12151-1-SWSA

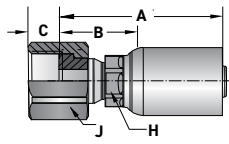

ToughShield Plus

*Construction: Steel

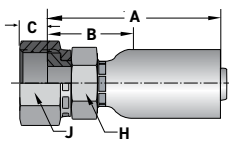

Construction: Steel. Add "C" for Stainless Steel.

| Part Number | Thread Size | Hose I.D. | | A | | Cutoff Allow. B | | C | | H Hex | J Hex |
|-------------|-------------|-----------|----|------|----|-----------------|----|------|----|-------|-------|
| | | inch | mm | inch | mm | inch | mm | inch | mm | inch | inch |
| 1JC56-4-2 | 9/16-18 | 1/8 | 3 | 1.34 | 34 | 3/4 | 19 | 5/16 | 8 | 5/8 | 11/16 |
| 1JC56-4-3 | 9/16-18 | 3/16 | 5 | 1.58 | 40 | 7/8 | 22 | 5/16 | 8 | 9/16 | 11/16 |
| 1JC56-4-4* | 9/16-18 | 1/4 | 6 | 1.86 | 47 | 7/8 | 22 | 5/16 | 8 | 7/16 | 11/16 |
| 1JC56-4-4C | 9/16-18 | 1/4 | 6 | 1.86 | 47 | 7/8 | 22 | 5/16 | 8 | 9/16 | 11/16 |
| 1JC56-6-4* | 11/16-16 | 1/4 | 6 | 1.90 | 48 | 15/16 | 24 | .34 | 9 | 7/16 | 11/16 |
| 1JC56-6-4C | 11/16-16 | 1/4 | 6 | 1.90 | 48 | 15/16 | 24 | .34 | 9 | 11/16 | 13/16 |
| 1JC56-4-5 | 9/16-18 | 5/16 | 8 | 1.81 | 46 | 13/16 | 21 | 5/16 | 8 | 11/16 | 11/16 |
| 1JC56-6-5 | 11/16-16 | 5/16 | 8 | 1.95 | 49 | 15/16 | 24 | .34 | 9 | 11/16 | 13/16 |
| 1JC56-4-6 | 9/16-18 | 3/8 | 10 | 1.91 | 48 | 15/16 | 24 | 5/16 | 8 | 5/8 | 11/16 |
| 1JC56-6-6* | 11/16-16 | 3/8 | 10 | 1.89 | 48 | 7/8 | 22 | .34 | 9 | 9/16 | 13/16 |
| 1JC56-6-6C | 11/16-16 | 3/8 | 10 | 1.89 | 48 | 7/8 | 22 | .34 | 9 | 11/16 | 13/16 |
| 1JC56-8-6* | 13/16-16 | 3/8 | 10 | 2.00 | 51 | 1 | 25 | 7/16 | 11 | 9/16 | 15/16 |
| 1JC56-8-6C | 13/16-16 | 3/8 | 10 | 2.00 | 51 | 1 | 25 | 7/16 | 11 | 13/16 | 15/16 |
| 1JC56-8-8* | 13/16-16 | 1/2 | 13 | 2.13 | 54 | 1 | 25 | 7/16 | 11 | 11/16 | 15/16 |
| 1JC56-8-8C | 13/16-16 | 1/2 | 13 | 2.13 | 54 | 1 | 25 | 7/16 | 11 | 13/16 | 15/16 |
| 1JC56-10-8 | 1-14 | 1/2 | 13 | 2.30 | 58 | 1-3/16 | 30 | .48 | 12 | 15/16 | 1-1/8 |
| 1JC56-10-10 | 1-14 | 5/8 | 16 | 2.48 | 63 | 1-3/16 | 30 | .48 | 12 | 15/16 | 1-1/8 |
| 1JC56-12-12 | 1-3/16-12 | 3/4 | 19 | 2.54 | 65 | 1-3/16 | 30 | 9/16 | 14 | 1-1/8 | 1-3/8 |
| 1JC56-16-16 | 1-7/16-12 | 1 | 25 | 3.21 | 82 | 1-5/16 | 33 | 9/16 | 14 | 1-3/8 | 1-5/8 |

NOTE: When measuring overall length to the end of the nut, B+C dimensions must be used to calculate cut-off allowance.

WARNING

This product can expose you to chemicals including Lead, which is known to the State of California to cause cancer and birth defects or other reproductive harm. For more information go to www.P65Warnings.ca.gov.

Fittings - Permanent Crimp

56 Series

A Hose

1JS56 Female Seal-Lok™ Straight ISO 12151-1-SWSB

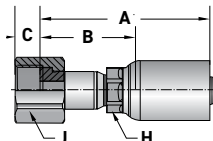

ToughShield Plus

*Construction: Steel

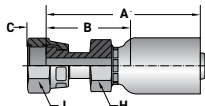

Construction: Steel. Add "C" for Stainless Steel.

| Part Number | Thread Size | Hose I.D. | | A | | Cutoff Allow. B | | C | | H Hex inch | J Hex inch |
|-------------|-------------|-----------|----|------|----|-----------------|----|------|----|------------|------------|
| | | inch | mm | inch | mm | inch | mm | inch | mm | | |
| 1JS56-4-3 | 9/16-18 | 3/16 | 5 | 1.89 | 48 | 1-3/16 | 30 | 0.31 | 8 | 9/16 | 11/16 |
| 1JS56-4-4* | 9/16-18 | 1/4 | 6 | 2.17 | 51 | 1-3/16 | 30 | 0.31 | 8 | 7/16 | 11/16 |
| 1JS56-4-4C | 9/16-18 | 1/4 | 6 | 2.17 | 51 | 1-3/16 | 30 | 0.31 | 8 | 9/16 | 11/16 |
| 1JS56-6-4* | 11/16-16 | 1/4 | 6 | 2.24 | 57 | 1-1/4 | 32 | 0.35 | 9 | 7/16 | 13/16 |
| 1JS56-6-4C | 11/16-16 | 1/4 | 6 | 2.24 | 57 | 1-1/4 | 32 | 0.35 | 9 | 11/16 | 13/16 |
| 1JS56-6-5 | 11/16-16 | 5/16 | 8 | 2.29 | 58 | 1-1/4 | 32 | 0.35 | 9 | 11/16 | 13/16 |
| 1JS56-6-6* | 11/16-16 | 3/8 | 10 | 2.28 | 58 | 1-15/16 | 33 | 0.35 | 9 | 9/16 | 13/16 |
| 1JS56-6-6C | 11/16-16 | 3/8 | 10 | 2.28 | 58 | 1-15/16 | 33 | 0.35 | 9 | 11/16 | 13/16 |
| 1JS56-8-6* | 13/16-16 | 3/8 | 10 | 2.40 | 61 | 1-7/16 | 36 | 0.43 | 11 | 9/16 | 15/16 |
| 1JS56-8-6C | 13/16-16 | 3/8 | 10 | 2.40 | 61 | 1-7/16 | 36 | 0.43 | 11 | 13/16 | 15/16 |
| 1JS56-6-8 | 11/16-16 | 1/2 | 13 | 2.40 | 61 | 1-5/16 | 33 | 0.35 | 9 | 3/4 | 13/16 |
| 1JS56-8-8* | 13/16-16 | 1/2 | 13 | 2.52 | 64 | 1-3/8 | 35 | 0.43 | 11 | 11/16 | 15/16 |
| 1JS56-8-8C | 13/16-16 | 1/2 | 13 | 2.52 | 64 | 1-3/8 | 35 | 0.43 | 11 | 13/16 | 15/16 |
| 1JS56-10-8 | 1-14 | 1/2 | 13 | 2.68 | 68 | 1-9/16 | 40 | 0.48 | 12 | 15/16 | 1-1/8 |
| 1JS56-10-10 | 1-14 | 5/8 | 16 | 2.92 | 74 | 1-5/8 | 41 | 0.48 | 12 | 15/16 | 1-1/8 |
| 1JS56-12-12 | 1-3/16-12 | 3/4 | 19 | 3.17 | 81 | 1-13/16 | 46 | 0.55 | 14 | 1-1/8 | 1-3/8 |
| 1JS56-16-16 | 1-7/16-12 | 1 | 25 | 3.76 | 96 | 1-7/8 | 48 | 0.57 | 14 | 1-3/8 | 1-5/8 |

NOTE: When measuring overall length to the end of the nut, B+C dimensions must be used to calculate cut-off allowance.

B Tubing Thermoplastic

C Coiled Air Hose & Fittings

1J256 Female Seal-Lok™ Swivel 30° Elbow

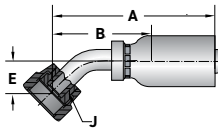

Construction: Steel. Add "C" for Stainless Steel.

| Part Number | Thread Size | Hose I.D. | | A | | Cutoff Allow. B | | E | | J Hex inch |
|-------------|-------------|-----------|----|------|----|-----------------|----|------|----|------------|
| | | inch | mm | inch | mm | inch | mm | inch | mm | |
| 1J256-8-8 | 13/16-16 | 1/2 | 13 | 2.84 | 72 | 1-11/16 | 43 | .43 | 11 | 15/16 |

D Transportation

1J556 Female Seal-Lok™ Swivel 90° Elbow Medium Drop ISO 12151-1-SWEM90

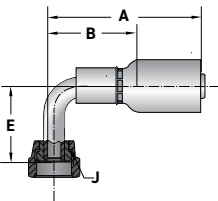

Construction: Steel. Add "C" for Stainless Steel.

| Part Number | Thread Size | Hose I.D. | | A | | Cutoff Allow. B | | E | | J Hex inch |
|-------------|-------------|-----------|----|------|-----|-----------------|----|------|----|------------|
| | | inch | mm | inch | mm | inch | mm | inch | mm | |
| 1J556-4-3 | 9/16-18 | 3/16 | 5 | 1.89 | 48 | 1-3/16 | 30 | 1.26 | 32 | 11/16 |
| 1J556-4-4 | 9/16-18 | 1/4 | 6 | 2.14 | 53 | 1-1/8 | 28 | 1.26 | 32 | 11/16 |
| 1J556-6-4 | 11/16-16 | 1/4 | 6 | 2.14 | 55 | 1-3/16 | 30 | 1.50 | 38 | 13/16 |
| 1J556-6-5 | 11/16-16 | 5/16 | 8 | 2.28 | 58 | 1-1/4 | 32 | 1.50 | 38 | 13/16 |
| 1J556-6-6 | 11/16-16 | 3/8 | 10 | 2.42 | 61 | 1-7/16 | 36 | 1.50 | 38 | 13/16 |
| 1J556-8-6 | 13/16-16 | 3/8 | 10 | 2.22 | 56 | 1-1/4 | 32 | 1.61 | 41 | 15/16 |
| 1J556-8-8 | 13/16-16 | 1/2 | 13 | 2.48 | 63 | 1-3/8 | 35 | 1.61 | 41 | 15/16 |
| 1J556-10-8 | 1-14 | 1/2 | 13 | 2.48 | 63 | 1-3/8 | 35 | 1.85 | 47 | 1-1/8 |
| 1J556-10-10 | 1-14 | 5/8 | 16 | 2.83 | 72 | 1-1/2 | 38 | 1.85 | 47 | 1-1/8 |
| 1J556-12-12 | 1-3/16-12 | 3/4 | 19 | 3.59 | 91 | 2-1/4 | 57 | 2.28 | 58 | 1-3/8 |
| 1J556-16-16 | 1-7/16-12 | 1 | 25 | 4.36 | 111 | 2-1/2 | 63 | 2.80 | 71 | 1-5/8 |

E Fittings

F Tooling, Equipment & Accessories



WARNING

This product can expose you to chemicals including Lead, which is known to the State of California to cause cancer and birth defects or other reproductive harm. For more information go to www.P65Warnings.ca.gov.

G General Technical

Fittings - Permanent Crimp

56 Series

1J756 Female Seal-Lok™ Swivel 45° Elbow ISO 12151-1-SWE45

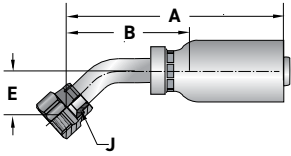

Construction: Steel. Add "C" for Stainless Steel.

| Part Number | Thread Size | Hose I.D. | | A | | Cutoff Allow. B | | E | | J |
|-------------|-------------|-----------|----|------|-----|-----------------|----|------|----|----------|
| | | inch | mm | inch | mm | inch | mm | inch | mm | Hex inch |
| 1J756-4-2 | 9/16-18 | 1/8 | 3 | 2.07 | 53 | 1-7/16 | 36 | .39 | 10 | 11/16 |
| 1J756-4-3 | 9/16-18 | 3/16 | 5 | 2.00 | 51 | 1-5/16 | 33 | .39 | 10 | 11/16 |
| 1J756-4-4 | 9/16-18 | 1/4 | 6 | 2.25 | 57 | 1-1/4 | 32 | .39 | 10 | 11/16 |
| 1J756-6-4 | 11/16-16 | 1/4 | 6 | 2.27 | 58 | 1-5/16 | 33 | .43 | 11 | 13/16 |
| 1J756-6-5 | 11/16-16 | 5/16 | 8 | 2.32 | 59 | 1-3/8 | 35 | .43 | 11 | 13/16 |
| 1J756-4-6 | 9/16-18 | 3/8 | 10 | 2.25 | 57 | 1-1/4 | 32 | .39 | 10 | 11/16 |
| 1J756-6-6 | 11/16-16 | 3/8 | 10 | 2.35 | 60 | 1-3/8 | 35 | .43 | 11 | 13/16 |
| 1J756-8-6 | 13/16-16 | 3/8 | 10 | 2.54 | 65 | 1-9/16 | 40 | .59 | 15 | 15/16 |
| 1J756-8-8 | 13/16-16 | 1/2 | 13 | 2.72 | 69 | 1-5/8 | 41 | .59 | 15 | 15/16 |
| 1J756-10-10 | 1-14 | 5/8 | 16 | 3.27 | 83 | 2 | 50 | .63 | 16 | 1-1/8 |
| 1J756-12-12 | 1-3/16-12 | 3/4 | 19 | 4.03 | 102 | 2-11/16 | 68 | .83 | 21 | 1-3/8 |
| 1J756-16-16 | 1-7/16-12 | 1 | 25 | 4.53 | 115 | 2.63 | 67 | .94 | 24 | 1-5/8 |

1J956 Female Seal-Lok™ Swivel 90° Elbow Short Drop ISO 12151-1-SWE90

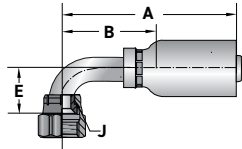

Construction: Steel. Add "C" for Stainless Steel.

| Part Number | Thread Size | Hose I.D. | | A | | Cutoff Allow. B | | E | | J |
|-------------|-------------|-----------|----|------|-----|-----------------|----|------|----|----------|
| | | inch | mm | inch | mm | inch | mm | inch | mm | Hex inch |
| 1J956-4-2 | 9/16-18 | 1/8 | 3 | 2.04 | 52 | 1-7/16 | 36 | .83 | 21 | 11/16 |
| 1J956-4-3 | 9/16-18 | 3/16 | 5 | 1.89 | 48 | 1-3/16 | 30 | .83 | 21 | 11/16 |
| 1J956-4-4 | 9/16-18 | 1/4 | 6 | 2.09 | 53 | 1-1/8 | 28 | .83 | 21 | 11/16 |
| 1J956-6-4 | 11/16-16 | 1/4 | 6 | 2.14 | 55 | 1-3/16 | 30 | .91 | 23 | 13/16 |
| 1J956-6-5 | 11/16-16 | 5/16 | 8 | 2.28 | 58 | 1-1/4 | 32 | .91 | 23 | 13/16 |
| 1J956-6-6 | 11/16-16 | 3/8 | 10 | 2.22 | 56 | 1-1/4 | 32 | .91 | 23 | 13/16 |
| 1J956-8-6 | 13/16-16 | 3/8 | 10 | 2.22 | 56 | 1-1/4 | 32 | 1.14 | 29 | 15/16 |
| 1J956-8-8 | 13/16-16 | 1/2 | 13 | 2.48 | 63 | 1-3/8 | 35 | 1.14 | 29 | 15/16 |
| 1J956-10-8 | 1-14 | 1/2 | 13 | 2.78 | 71 | 1-11/16 | 35 | 1.26 | 32 | 1-1/8 |
| 1J956-10-10 | 1-14 | 5/8 | 16 | 3.14 | 80 | 1-13/16 | 46 | 1.26 | 32 | 1-1/8 |
| 1J956-12-12 | 1-3/16-12 | 3/4 | 19 | 3.89 | 99 | 2-9/16 | 65 | 1.89 | 48 | 1-3/8 |
| 1J956-16-16 | 1-7/16-12 | 1 | 25 | 4.66 | 118 | 2-3/4 | 70 | 2.20 | 56 | 1-5/8 |

1TU56 Universal Inch Tube Stub End

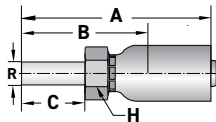

Construction: Steel. Add "C" for Stainless Steel.

| Part Number | Diameter R | Hose I.D. | | A | | Cutoff Allow. B | | C | | H |
|-------------|------------|-----------|----|------|-----|-----------------|----|------|----|----------|
| | | inch | mm | inch | mm | inch | mm | inch | mm | Hex inch |
| 1TU56-4-4 | 1/4 | 1/4 | 6 | 2.35 | 60 | 1-3/8 | 35 | .72 | 18 | 11/16 |
| 1TU56-6-4 | 3/8 | 1/4 | 6 | 2.41 | 61 | 1-7/16 | 36 | .78 | 20 | 15/16 |
| 1TU56-6-6 | 3/8 | 3/8 | 10 | 2.46 | 62 | 1-7/16 | 36 | .78 | 20 | 1-1/8 |
| 1TU56-8-8 | 1/2 | 1/2 | 13 | 2.68 | 68 | 1-9/16 | 40 | 1.03 | 26 | 1-1/8 |
| 1TU56-12-12 | 3/4 | 3/4 | 19 | 2.88 | 73 | 1-9/16 | 40 | 1.03 | 26 | 1-3/8 |
| 1TU56-16-16 | 1 | 1 | 25 | 4.03 | 102 | 1-7/8 | 48 | 1.03 | 26 | 1-5/8 |

WARNING

This product can expose you to chemicals including Lead, which is known to the State of California to cause cancer and birth defects or other reproductive harm. For more information go to www.P65Warnings.ca.gov.

Fittings - Permanent Crimp

56 Series

10C56 – Metric Female Swivel 24° With O-ring 45° Elbow Heavy Series ISO 12151-2

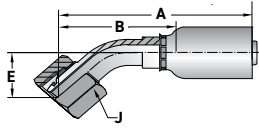

Construction: Steel. Add "C" for Stainless Steel.

| Part Number | Thread Size | Hose I.D. | | A | | Cutoff Allow. B | | E | | J Hex |
|-------------|-------------|-----------|------|----|------|-----------------|------|----|------|-------|
| | | mm | inch | mm | inch | mm | inch | mm | inch | mm |
| 10C56-6-3 | M14x1.5 | 5 | 3/16 | 58 | 2.28 | 40 | 1.57 | 16 | 0.63 | 17 |
| 10C56-8-3 | M16x1.5 | 5 | 3/16 | 59 | 2.32 | 41 | 1.61 | 18 | 0.71 | 19 |
| 10C56-10-4 | M18x1.5 | 6 | 1/4 | 64 | 2.52 | 40 | 1.57 | 17 | 0.67 | 22 |
| 10C56-12-5 | M20x1.5 | 8 | 5/16 | 69 | 2.72 | 43 | 1.69 | 17 | 0.67 | 24 |
| 10C56-12-6 | M20x1.5 | 10 | 3/8 | 75 | 2.95 | 49 | 1.93 | 20 | 0.79 | 24 |
| 10C56-16-8 | M24x1.5 | 13 | 1/2 | 80 | 3.15 | 51 | 2.01 | 23 | 0.91 | 30 |

NOTE: Nitrile O-ring.

11C56 – Metric Female Swivel 24° With O-ring 90° Elbow Heavy Series ISO 12151-2

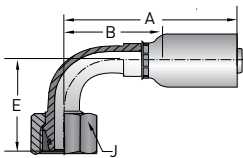

Construction: Steel. Add "C" for Stainless Steel.

| Part Number | Thread Size | Hose I.D. | | A | | Cutoff Allow. B | | E | | J Hex |
|-------------|-------------|-----------|------|----|------|-----------------|------|----|------|-------|
| | | mm | inch | mm | inch | mm | inch | mm | inch | mm |
| 11C56-8-3 | M16x1.5 | 5 | 3/16 | 48 | 1.89 | 30 | 1.18 | 29 | 1.14 | 19 |
| 11C56-10-4 | M18x1.5 | 6 | 1/4 | 53 | 2.09 | 29 | 1.14 | 32 | 1.26 | 22 |
| 11C56-12-5 | M20x1.5 | 8 | 5/16 | 65 | 2.56 | 39 | 1.54 | 34 | 1.34 | 24 |
| 11C56-12-6 | M20x1.5 | 10 | 3/8 | 63 | 2.48 | 38 | 1.5 | 37 | 1.46 | 24 |
| 11C56-16-8 | M24x1.5 | 13 | 1/2 | 68 | 2.68 | 40 | 1.57 | 45 | 1.77 | 30 |

NOTE: Nitrile O-ring.

19256 Female BSP Parallel Pipe Swivel Straight (60° Cone)

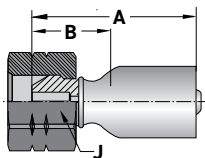

Construction: Steel. Add "C" for Stainless Steel.

| Part Number | Thread Size | Hose I.D. | | A | | Cutoff Allow. B | | J Hex |
|-------------|-------------|-----------|------|----|------|-----------------|------|-------|
| | | mm | inch | mm | inch | mm | inch | mm |
| 19256-4-3 | G 1/4 | 5 | 3/16 | 35 | 1.38 | 17 | 0.67 | 19 |
| 19256-2-4 | G 1/8 | 6 | 1/4 | 43 | 1.69 | 18 | 0.71 | 14 |
| 19256-4-4 | G 1/4 | 6 | 1/4 | 42 | 1.65 | 17 | 0.67 | 19 |
| 19256-6-4 | G 3/8 | 6 | 1/4 | 45 | 1.77 | 20 | 0.79 | 22 |
| 19256-4-5 | G 1/4 | 8 | 5/16 | 47 | 1.85 | 21 | 0.83 | 19 |
| 19256-6-5 | G 3/8 | 8 | 5/16 | 46 | 1.81 | 20 | 0.79 | 22 |
| 19256-6-6 | G 3/8 | 10 | 3/8 | 46 | 1.81 | 21 | 0.83 | 22 |
| 19256-8-6 | G 1/2 | 10 | 3/8 | 48 | 1.77 | 23 | 0.91 | 27 |
| 19256-6-8 | G 3/8 | 13 | 1/2 | 53 | 2.09 | 25 | 0.98 | 22 |
| 19256-8-8 | G 1/2 | 13 | 1/2 | 51 | 2.01 | 23 | 0.91 | 27 |
| 19256-10-8 | G 5/8 | 13 | 1/2 | 49 | 1.93 | 22 | 0.87 | 30 |
| 19256-12-12 | G 3/4 | 19 | 3/4 | 60 | 2.36 | 26 | 1.02 | 32 |
| 19256-16-16 | G 1 | 25 | 1 | 74 | 2.91 | 26 | 1.02 | 41 |

WARNING

This product can expose you to chemicals including Lead, which is known to the State of California to cause cancer and birth defects or other reproductive harm. For more information go to www.P65Warnings.ca.gov.

Fittings - Permanent Crimp

56 Series

1AL56 A-LOK® Compression (With Nut and Ferrule)

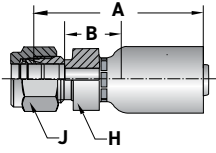

Construction: 316 Stainless nipple and shell.

| Part Number | Thread Size | Hose I.D. | | A | | Cutoff Allow. B | | H Hex | J Hex |
|-------------|-------------|-----------|----|------|----|-----------------|----|-------|-------|
| | | inch | mm | inch | mm | inch | mm | inch | inch |
| 1AL56-4-4C | 7/16-20 | 1/4 | 6 | 1/4 | 6 | 1.91 | 49 | 9/16 | 9/16 |
| 1AL56-6-6C | 9/16-20 | 3/8 | 10 | 3/8 | 10 | 2.09 | 53 | 11/16 | 11/16 |
| 1AL56-8-8C | 3/4-20 | 1/2 | 13 | 3/8 | 10 | 2.21 | 56 | 7/8 | 7/8 |

NOTE: Nut part No. is XNUX or XNUX-316 for stainless steel.
 Front ferrule part No. is XFFX or XFFX-316 for stainless steel.
 Back ferrule part No. is XBFX or XBFX-316 for stainless steel.
 X denotes dash size.

1B156 – Female BSP Parallel Pipe Swivel 45° Elbow (60° Cone) ISO 228-1

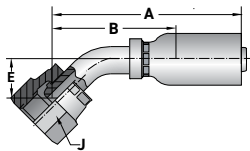

Construction: Steel. Add "C" for Stainless Steel.

| Part Number | Thread Size | Hose I.D. | | A | | Cutoff Allow. B | | E | | J Hex |
|-------------|-------------|-----------|------|-----|------|-----------------|------|----|-------|-------|
| | | mm | inch | mm | inch | mm | inch | mm | inch | mm |
| 1B156-4-3 | G 1/4 | 5 | 3/16 | 57 | 2.24 | 15 | 0.59 | 39 | 1.542 | 19 |
| 1B156-4-4 | G 1/4 | 6 | 1/4 | 62 | 2.44 | 15 | 0.59 | 38 | 1.5 | 19 |
| 1B156-6-5 | G 3/8 | 8 | 5/16 | 65 | 2.56 | 17 | 0.67 | 39 | 1.54 | 22 |
| 1B156-6-6 | G 3/8 | 10 | 3/8 | 67 | 2.64 | 17 | 0.67 | 42 | 1.65 | 22 |
| 1B156-8-8 | G 1/2 | 13 | 1/2 | 77 | 3.03 | 20 | 0.79 | 48 | 1.89 | 27 |
| 1B156-12-12 | G 3/4 | 19 | 3/4 | 99 | 3.9 | 25 | 1 | 65 | 2.56 | 32 |
| 1B156-16-16 | G 1 | 25 | 1 | 127 | 5 | 31 | 1.22 | 79 | 3.11 | 41 |

1B256 – Female BSP Parallel Pipe Swivel 90° Elbow (60° Cone) ISO 228-1

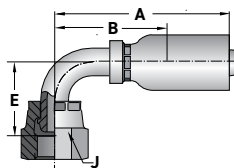

Construction: Steel. Add "C" for Stainless Steel.

| Part Number | Thread Size | Hose I.D. | | A | | Cutoff Allow. B | | E | | J Hex |
|-------------|-------------|-----------|------|-----|------|-----------------|------|----|------|-------|
| | | mm | inch | mm | inch | mm | inch | mm | inch | mm |
| 1B256-4-3 | G 1/4 | 5 | 3/16 | 48 | 1.89 | 28 | 1.10 | 30 | 1.18 | 19 |
| 1B256-4-4 | G 1/4 | 6 | 1/4 | 53 | 2.09 | 28 | 1.10 | 29 | 1.14 | 19 |
| 1B256-4-5 | G 1/4 | 8 | 5/16 | 56 | 2.20 | 34 | 1.34 | 30 | 1.18 | 19 |
| 1B256-6-5 | G 3/8 | 8 | 5/16 | 55 | 2.16 | 30 | 1.18 | 30 | 1.18 | 22 |
| 1B256-6-6 | G 3/8 | 10 | 3/8 | 60 | 2.36 | 33 | 1.30 | 31 | 1.22 | 22 |
| 1B256-8-8 | G 1/2 | 13 | 1/2 | 70 | 2.76 | 40 | 1.57 | 42 | 1.65 | 27 |
| 1B256-12-12 | G 3/4 | 19 | 3/4 | 92 | 3.62 | 52 | 2.05 | 58 | 2.28 | 32 |
| 1B256-16-16 | G 1 | 25 | 1 | 125 | 4.92 | 68 | 2.68 | 77 | 3.03 | 41 |

WARNING

This product can expose you to chemicals including Lead, which is known to the State of California to cause cancer and birth defects or other reproductive harm. For more information go to www.P65Warnings.ca.gov.

Fittings - Permanent Crimp

56 Series

1C356 – Metric Female Swivel Nut Light Series, 24°/60°

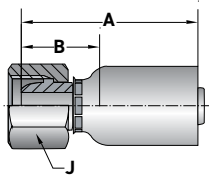

Construction: Steel. Add "C" for Stainless Steel.

| Part Number | Thread Size | Hose I.D. | | A | | Cutoff Allow. B | | J Hex mm |
|-------------|-------------|-----------|------|----|------|-----------------|------|----------|
| | | mm | inch | mm | inch | mm | inch | |
| 1C356-6-3 | M12x1.5 | 5 | 3/16 | 37 | 1.46 | 20 | 0.79 | 14 |
| 1C356-8-4 | M14x1.5 | 6 | 1/4 | 44 | 1.73 | 20 | 0.79 | 17 |
| 1C356-10-4 | M16x1.5 | 6 | 1/4 | 45 | 1.77 | 21 | 0.83 | 19 |
| 1C356-10-5 | M16x1.5 | 8 | 5/16 | 46 | 1.81 | 20 | 0.79 | 19 |
| 1C356-12-5 | M18x1.5 | 8 | 5/16 | 47 | 1.85 | 21 | 0.83 | 22 |
| 1C356-10-6 | M16x1.5 | 10 | 3/8 | 46 | 1.81 | 21 | 0.83 | 19 |
| 1C356-12-6 | M18x1.5 | 10 | 3/8 | 47 | 1.85 | 21 | 0.83 | 22 |
| 1C356-15-6 | M22x1.5 | 10 | 3/8 | 46 | 1.81 | 21 | 0.83 | 27 |
| 1C356-15-8 | M22x1.5 | 13 | 1/2 | 50 | 1.97 | 21 | 0.83 | 27 |
| 1C356-18-10 | M26x1.5 | 16 | 5/8 | 57 | 2.24 | 25 | 0.98 | 32 |
| 1C356-18-12 | M26x1.5 | 19 | 3/4 | 58 | 2.28 | 24 | 0.94 | 32 |
| 1C356-22-12 | M30x2 | 19 | 3/4 | 60 | 2.36 | 27 | 1.06 | 36 |

1C456 – Metric Female Swivel 45° Elbow Light Series, 24°/60°

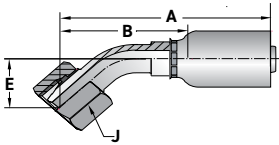

Construction: Steel. Add "C" for Stainless Steel.

| Part Number | Thread Size | Hose I.D. | | A | | Cutoff Allow. B | | E | | J Hex mm |
|-------------|-------------|-----------|------|----|------|-----------------|------|----|------|----------|
| | | mm | inch | mm | inch | mm | inch | mm | inch | |
| 1C456-6-3 | M12x1.5 | 5 | 3/16 | 57 | 2.24 | 40 | 1.57 | 16 | 0.63 | 14 |
| 1C456-8-4 | M14x1.5 | 6 | 1/4 | 60 | 2.36 | 36 | 1.42 | 14 | 0.55 | 17 |
| 1C456-10-5 | M16x1.5 | 8 | 5/16 | 62 | 2.44 | 37 | 1.46 | 15 | 0.59 | 19 |
| 1C456-10-6 | M16x1.5 | 10 | 3/8 | 67 | 2.64 | 41 | 1.61 | 17 | 0.67 | 19 |
| 1C456-12-6 | M18x1.5 | 10 | 3/8 | 72 | 2.83 | 47 | 1.85 | 18 | 0.71 | 22 |
| 1C456-15-8 | M22x1.5 | 13 | 1/2 | 76 | 2.99 | 48 | 1.89 | 19 | 0.75 | 27 |

1C556 – Metric Female Swivel 90° Elbow Light Series, 24°/60°

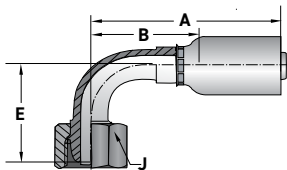

Construction: Steel. Add "C" for Stainless Steel.

| Part Number | Thread Size | Hose I.D. | | A | | Cutoff Allow. B | | E | | J Hex mm |
|-------------|-------------|-----------|------|----|------|-----------------|------|----|------|----------|
| | | mm | inch | mm | inch | mm | inch | mm | inch | |
| 1C556-6-3 | M12x1.5 | 5 | 3/16 | 48 | 1.89 | 30 | 1.18 | 30 | 1.18 | 14 |
| 1C556-8-4 | M14x1.5 | 6 | 1/4 | 53 | 2.09 | 28 | 1.10 | 26 | 1.02 | 17 |
| 1C556-10-4 | M16x1.5 | 6 | 1/4 | 53 | 2.09 | 28 | 1.10 | 27 | 1.06 | 19 |
| 1C556-12-5 | M18x1.5 | 8 | 5/16 | 58 | 2.28 | 33 | 1.30 | 34 | 1.34 | 22 |
| 1C556-10-6 | M16x1.5 | 10 | 3/8 | 63 | 2.48 | 38 | 1.50 | 33 | 1.30 | 19 |
| 1C556-12-6 | M18x1.5 | 10 | 3/8 | 63 | 2.48 | 38 | 1.50 | 34 | 1.34 | 22 |
| 1C556-15-8 | M22x1.5 | 13 | 1/2 | 72 | 2.83 | 44 | 1.73 | 39 | 1.54 | 27 |
| 1C556-18-12 | M26x1.5 | 19 | 3/4 | 87 | 3.43 | 53 | 2.09 | 52 | 2.05 | 32 |

WARNING

This product can expose you to chemicals including Lead, which is known to the State of California to cause cancer and birth defects or other reproductive harm. For more information go to www.P65Warnings.ca.gov.

Fittings - Permanent Crimp

56 Series

1C656 – Female Metric Swivel DIN 20078 Heavy Series (Without O-ring) ISO 8434-1

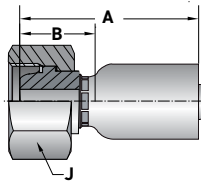

Construction: 316 Stainless nipple and shell.

| Part Number | Thread Size | Hose I.D. | | A | | Cutoff Allow. B | | J Hex inch |
|-------------|-------------|-----------|------|------|------|-----------------|------|------------|
| | | inch | mm | inch | mm | inch | mm | |
| 1C656-8-3 | M16x1.5 | 5 | 3/16 | 38 | 1.50 | 20 | 0.79 | 19 |
| 1C656-10-4 | M18x1.5 | 6 | 1/4 | 47 | 1.85 | 22 | 0.87 | 22 |
| 1C656-12-5 | M20x1.5 | 8 | 5/16 | 50 | 1.97 | 24 | 0.94 | 24 |
| 1C656-12-6 | M20x1.5 | 10 | 3/8 | 49 | 1.93 | 24 | 0.94 | 24 |
| 1C656-14-6 | M22x1.5 | 10 | 3/8 | 49 | 1.93 | 23 | 0.89 | 27 |
| 1C656-16-8 | M24x1.5 | 10 | 1/2 | 53 | 2.09 | 25 | 0.98 | 30 |
| 1C656-20-12 | M30x2 | 13 | 3/4 | 61 | 2.40 | 27 | 1.06 | 36 |

1C956 – Female Metric Swivel DIN 20078 Heavy Series (With O-ring) ISO 12151-2-SWS

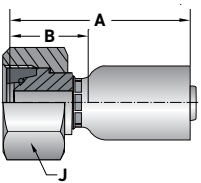

Construction: Steel. Add "C" for Stainless Steel.

| Part Number | Thread Size | Hose I.D. | | A | | Cutoff Allow. B | | E | | J Hex mm |
|-------------|-------------|-----------|------|----|------|-----------------|------|----|-------|----------|
| | | mm | inch | mm | inch | mm | inch | mm | inch | |
| 1C956-8-3 | M16x1.5 | 5 | 3/16 | 41 | 1.61 | 23 | 0.91 | 19 | 1.542 | 19 |
| 1C956-8-4 | M16x1.5 | 6 | 1/4 | 48 | 1.89 | 23 | 0.91 | 19 | 1.5 | 19 |
| 1C956-10-4 | M18x1.5 | 6 | 1/4 | 48 | 1.89 | 23 | 0.91 | 22 | 1.54 | 22 |
| 1C956-12-4 | M20x1.5 | 6 | 1/4 | 48 | 1.89 | 24 | 0.94 | 24 | 1.65 | 22 |
| 1C956-10-5 | M18x1.5 | 8 | 5/16 | 49 | 1.93 | 23 | 0.91 | 22 | 1.5 | 19 |
| 1C956-12-5 | M20x1.5 | 8 | 5/16 | 50 | 1.97 | 24 | 0.94 | 24 | 1.54 | 22 |
| 1C956-12-6 | M20x1.5 | 10 | 3/8 | 49 | 1.93 | 24 | 0.94 | 24 | 1.65 | 22 |
| 1C956-14-6 | M22x1.5 | 10 | 3/8 | 49 | 1.93 | 24 | 0.94 | 27 | 1.5 | 19 |
| 1C956-16-8 | M24x1.5 | 10 | 1/2 | 56 | 2.17 | 27 | 1.06 | 30 | 1.54 | 22 |
| 1C956-20-12 | M30x2 | 19 | 3/4 | 65 | 2.56 | 31 | 1.22 | 36 | 1.65 | 22 |
| 1C956-25-12 | M36x2 | 19 | 3/4 | 66 | 2.6 | 32 | 1.3 | 46 | 3.11 | 41 |

NOTE: Nitrile O-ring.

WARNING

This product can expose you to chemicals including Lead, which is known to the State of California to cause cancer and birth defects or other reproductive harm. For more information go to www.P65Warnings.ca.gov.

Fittings - Permanent Crimp

56 Series

1CA56 – Metric Female Swivel 24° With O-ring Light Series ISO 12151-2-SWS

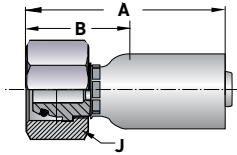

Construction: Steel. Add "C" for Stainless Steel.

| Part Number | Thread Size | Hose I.D. | | A | | Cutoff Allow. B | | J Hex mm |
|-------------|-------------|-----------|------|----|------|-----------------|------|----------|
| | | mm | inch | mm | inch | mm | inch | |
| 1CA56-6-3 | M12x1.5 | 5 | 3/16 | 40 | 1.57 | 22 | 0.87 | 14 |
| 1CA56-6-4 | M12x1.5 | 6 | 1/4 | 48 | 1.89 | 24 | 0.94 | 14 |
| 1CA56-8-4 | M14x1.5 | 6 | 1/4 | 47 | 1.85 | 23 | 0.91 | 17 |
| 1CA56-10-4 | M16x1.5 | 6 | 1/4 | 47 | 1.85 | 22 | 0.87 | 19 |
| 1CA56-12-4 | M18x1.5 | 6 | 1/4 | 47 | 1.85 | 22 | 0.87 | 22 |
| 1CA56-10-5 | M16x1.5 | 8 | 5/16 | 48 | 1.89 | 22 | 0.87 | 19 |
| 1CA56-12-5 | M18x1.5 | 8 | 5/16 | 48 | 1.89 | 22 | 0.87 | 22 |
| 1CA56-10-6 | M16x1.5 | 10 | 3/8 | 48 | 1.89 | 22 | 0.87 | 19 |
| 1CA56-12-6 | M18x1.5 | 10 | 3/8 | 48 | 1.89 | 22 | 0.87 | 22 |
| 1CA56-15-6 | M22x1.5 | 10 | 3/8 | 50 | 1.97 | 25 | 0.98 | 27 |
| 1CA56-12-8 | M18x1.5 | 13 | 1/2 | 53 | 2.09 | 27 | 1.06 | 22 |
| 1CA56-15-8 | M22x1.5 | 13 | 1/2 | 53 | 2.09 | 25 | 0.98 | 27 |
| 1CA56-18-8 | M26x1.5 | 13 | 1/2 | 53 | 2.09 | 25 | 0.98 | 32 |
| 1CA56-18-10 | M26x1.5 | 16 | 5/8 | 60 | 2.36 | 26 | 1.02 | 32 |
| 1CA56-18-12 | M26x1.5 | 19 | 3/4 | 60 | 2.36 | 26 | 1.02 | 32 |
| 1CA56-22-12 | M30x2 | 19 | 3/4 | 62 | 2.44 | 28 | 1.10 | 36 |
| 1CA56-28-16 | M36x2 | 25 | 1 | 77 | 3.03 | 28 | 1.10 | 41 |

NOTE: Nitrile O-ring.

1CE56 – Metric Female Swivel 24° With O-ring 45° Elbow Light Series ISO 12151-2-SWE45

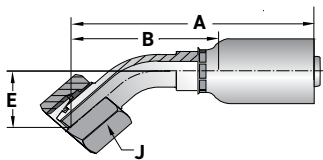

Construction: Steel. Add "C" for Stainless Steel.

| Part Number | Thread Size | Hose I.D. | | A | | Cutoff Allow. B | | E | | J Hex mm |
|-------------|-------------|-----------|------|-----|------|-----------------|------|----|------|----------|
| | | mm | inch | mm | inch | mm | inch | mm | inch | |
| 1CE56-6-3 | M12x1.5 | 5 | 3/16 | 58 | 2.28 | 40 | 1.57 | 17 | 0.67 | 14 |
| 1CE56-8-4 | M14x1.5 | 6 | 1/4 | 65 | 2.56 | 40 | 1.57 | 18 | 0.71 | 17 |
| 1CE56-10-4 | M16x1.5 | 6 | 1/4 | 62 | 2.44 | 38 | 1.50 | 16 | 0.63 | 19 |
| 1CE56-10-5 | M16x1.5 | 8 | 5/16 | 72 | 2.83 | 46 | 1.81 | 18 | 0.71 | 19 |
| 1CE56-10-6 | M16x1.5 | 10 | 3/8 | 75 | 2.95 | 50 | 1.97 | 19 | 0.75 | 19 |
| 1CE56-12-6 | M18x1.5 | 10 | 3/8 | 73 | 2.87 | 48 | 1.89 | 19 | 0.75 | 22 |
| 1CE56-15-8 | M22x1.5 | 13 | 1/2 | 78 | 3.07 | 50 | 1.97 | 22 | 0.87 | 27 |
| 1CE56-18-10 | M26x1.5 | 16 | 5/8 | 89 | 3.50 | 56 | 2.20 | 24 | 0.94 | 32 |
| 1CE56-18-12 | M26x1.5 | 19 | 3/4 | 101 | 3.74 | 67 | 2.64 | 27 | 1.06 | 32 |
| 1CE56-22-12 | M30x2 | 19 | 3/4 | 100 | 3.94 | 66 | 2.60 | 26 | 1.02 | 36 |
| 1CE56-28-16 | M36x2 | 25 | 1 | 133 | 5.27 | 85 | 3.35 | 33 | 1.30 | 41 |

NOTE: Nitrile O-ring.

WARNING

This product can expose you to chemicals including Lead, which is known to the State of California to cause cancer and birth defects or other reproductive harm. For more information go to www.P65Warnings.ca.gov.

Fittings - Permanent Crimp

56 Series

1CF56 – Metric Female Swivel 24° With O-ring 90° Elbow Light Series ISO 12151-2-SWE90

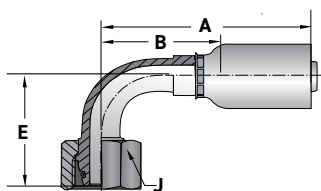

Construction: Steel. Add "C" for Stainless Steel.

| Part Number | Thread Size | Hose I.D. | | A | | Cutoff Allow. B | | E | | J Hex |
|-------------|-------------|-----------|------|-----|------|-----------------|------|----|------|-------|
| | | mm | inch | mm | inch | mm | inch | mm | inch | mm |
| 1CF56-6-3 | M12x1.5 | 5 | 3/16 | 48 | 1.89 | 30 | 1.18 | 30 | 1.18 | 14 |
| 1CF56-6-4 | M12x1.5 | 6 | 1/6 | 53 | 2.09 | 29 | 1.14 | 33 | 1.3 | 14 |
| 1CF56-8-4 | M14x1.5 | 6 | 1/6 | 55 | 2.17 | 30 | 1.18 | 29 | 1.14 | 17 |
| 1CF56-10-4 | M16x1.5 | 6 | 1/6 | 55 | 2.17 | 31 | 1.22 | 29 | 1.14 | 17 |
| 1CF56-10-5 | M16x1.5 | 8 | 5/16 | 66 | 2.6 | 40 | 1.57 | 29 | 1.14 | 19 |
| 1CF56-12-5 | M18x1.5 | 8 | 5/16 | 65 | 2.56 | 40 | 1.57 | 30 | 1.18 | 22 |
| 1CF56-10-6 | M16x1.5 | 10 | 3/8 | 64 | 2.52 | 39 | 1.54 | 37 | 1.46 | 19 |
| 1CF56-12-6 | M18x1.5 | 10 | 3/8 | 63 | 2.48 | 38 | 1.5 | 35 | 1.38 | 22 |
| 1CF56-15-8 | M22x1.5 | 13 | 1/2 | 68 | 2.68 | 40 | 1.57 | 43 | 1.69 | 27 |
| 1CF56-18-10 | M26x1.5 | 16 | 5/8 | 79 | 3.11 | 45 | 1.77 | 52 | 2.05 | 32 |
| 1CF56-22-12 | M30x2 | 19 | 3/4 | 91 | 3.58 | 57 | 2.24 | 55 | 2.17 | 36 |
| 1CF56-28-16 | M36x2 | 25 | 1 | 122 | 50 | 74 | 2.91 | 71 | 2.8 | 41 |

NOTE: Nitrile O-ring.

1FU56 – (JIS) /BSP 30° Flare Swivel Female

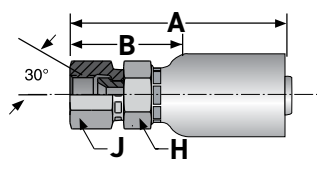

Construction: Steel. Add "C" for Stainless Steel.

| Part Number | Thread Size | Hose I.D. | | A | | Cutoff Allow. B | | H Hex | J Hex |
|-------------|-------------|-----------|----|------|----|-----------------|----|-------|-------|
| | | inch | mm | inch | mm | inch | mm | mm | mm |
| 1FU56-4-4 | G 1/4-19 | 1/4 | 6 | 2.19 | 56 | 1 1/4 | 31 | 19 | 19 |
| 1FU56-6-6 | G 3/8-19 | 3/8 | 10 | 2.36 | 60 | 1 3/8 | 35 | 22 | 22 |
| 1FU56-8-8 | G 1/2-14 | 1/2 | 13 | 2.68 | 68 | 1 9/16 | 40 | 27 | 27 |
| 1FU56-12-12 | G 3/4-14 | 3/4 | 19 | 3.02 | 77 | 1 11/16 | 43 | 36 | 36 |
| 1FU56-16-16 | G 1-11 | 1 | 25 | 3.76 | 96 | 1 7/8 | 48 | 41 | 41 |

WARNING

This product can expose you to chemicals including Lead, which is known to the State of California to cause cancer and birth defects or other reproductive harm. For more information go to www.P65Warnings.ca.gov.

Fittings - Permanent Crimp

56 Series

1D056 - Male Stud DIN 20078 Light Series ISO 8434-1

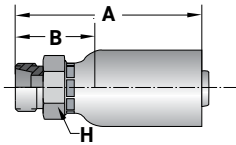

Construction: Steel. Add "C" for Stainless Steel.

| Part Number | Thread Size | Hose I.D. | | A | | Cutoff Allow. B | | H Hex mm |
|-------------|-------------|-----------|------|----|------|-----------------|------|----------|
| | | mm | inch | mm | inch | mm | inch | |
| 1D056-6-3 | M12x1.5 | 5 | 3/16 | 41 | 1.61 | 23 | 0.91 | 12 |
| 1D056-6-4 | M12x1.5 | 6 | 1/4 | 48 | 1.89 | 23 | 0.91 | 12 |
| 1D056-8-4 | M14x1.5 | 6 | 1/4 | 47 | 1.85 | 23 | 0.91 | 14 |
| 1D056-10-5 | M16x1.5 | 8 | 5/16 | 50 | 1.97 | 24 | 0.94 | 17 |
| 1D056-12-5 | M18x1.5 | 8 | 5/16 | 52 | 2.05 | 26 | 1.02 | 19 |
| 1D056-10-6 | M16x1.5 | 10 | 3/8 | 50 | 1.97 | 24 | 0.94 | 17 |
| 1D056-12-6 | M18x1.5 | 10 | 3/8 | 50 | 1.97 | 24 | 0.94 | 19 |
| 1D056-15-6 | M22x1.5 | 10 | 3/8 | 52 | 2.05 | 27 | 1.06 | 22 |
| 1D056-15-8 | M22x1.5 | 13 | 1/2 | 55 | 2.16 | 27 | 1.06 | 22 |
| 1D056-18-10 | M26x1.5 | 16 | 5/8 | 64 | 2.52 | 30 | 1.18 | 27 |
| 1D056-22-12 | M30x2 | 19 | 3/4 | 68 | 2.68 | 34 | 1.34 | 30 |
| 1D056-28-16 | M36x2 | 25 | 1 | 82 | 3.23 | 34 | 1.34 | 36 |

1D256 - Metric Male Stud 24° Heavy Series ISO 12151-2

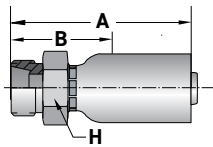

Construction: Steel. Add "C" for Stainless Steel.

| Part Number | Thread Size | Hose I.D. | | A | | Cutoff Allow. B | | H Hex mm |
|-------------|-------------|-----------|------|----|------|-----------------|------|----------|
| | | mm | inch | mm | inch | mm | inch | |
| 1D256-8-3 | M16x1.5 | 5 | 3/16 | 42 | 1.65 | 25 | 0.98 | 12 |
| 1D256-10-4 | M18x1.5 | 6 | 1/4 | 52 | 2.05 | 27 | 1.06 | 12 |
| 1D256-10-5 | M18x1.5 | 8 | 5/16 | 53 | 2.09 | 27 | 1.06 | 14 |
| 1D256-12-5 | M20x1.5 | 8 | 5/16 | 53 | 2.09 | 27 | 1.06 | 17 |
| 1D256-12-6 | M20x1.5 | 10 | 3/8 | 53 | 2.09 | 27 | 1.06 | 19 |
| 1D256-14-6 | M22x1.5 | 10 | 3/8 | 57 | 2.24 | 31 | 1.22 | 17 |
| 1D256-16-6 | M24x1.5 | 10 | 3/8 | 57 | 2.24 | 31 | 1.22 | 19 |
| 1D256-16-8 | M24x1.5 | 13 | 1/2 | 60 | 2.36 | 31 | 1.22 | 22 |
| 1D256-20-12 | M30x2 | 19 | 3/4 | 72 | 2.83 | 38 | 1.50 | 22 |

1D956 Male BSPP - Straight (60° Cone) ISO 228-1

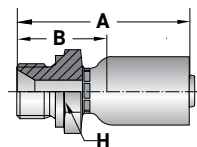

Construction: Steel. Add "C" for Stainless Steel.

| Part Number | Thread Size | Hose I.D. | | A | | Cutoff Allow. B | | H Hex mm |
|-------------|-------------|-----------|------|----|------|-----------------|------|----------|
| | | mm | inch | mm | inch | mm | inch | |
| 1D956-4-3 | G 1/4 | 5 | 3/16 | 44 | 1.73 | 27 | 1.06 | 19 |
| 1D956-4-4 | G 1/4 | 6 | 1/4 | 52 | 2.05 | 27 | 1.06 | 19 |
| 1D956-6-5 | G 3/8 | 8 | 5/16 | 53 | 2.09 | 27 | 1.06 | 22 |
| 1D956-6-6 | G 3/8 | 10 | 3/8 | 53 | 2.09 | 28 | 1.10 | 22 |
| 1D956-8-8 | G 1/2 | 13 | 1/2 | 60 | 2.36 | 32 | 1.26 | 27 |
| 1D956-12-12 | G 3/4 | 19 | 3/4 | 75 | 2.95 | 41 | 1.61 | 32 |
| 1D956-16-16 | G 1 | 25 | 1 | 91 | 3.58 | 42 | 1.65 | 41 |

WARNING

This product can expose you to chemicals including Lead, which is known to the State of California to cause cancer and birth defects or other reproductive harm. For more information go to www.P65Warnings.ca.gov.

Fittings - Permanent Crimp

56 Series Rapid Assembly

1WU56 Male Rapid Assembly Straight

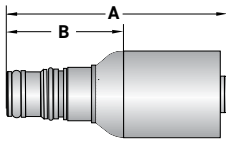

| Part Number | Stem O.D. | | Hose I.D. | | A | | Cutoff Allow. B | |
|-------------|-----------|----|-----------|----|------|----|-----------------|----|
| | inch | mm | inch | mm | inch | mm | inch | mm |
| 1WU56-4-4 | 1/4 | 6 | 1/4 | 6 | 2.18 | 55 | 1-1/8 | 29 |
| 1WU56-6-6 | 3/8 | 10 | 3/8 | 10 | 2.30 | 58 | 1-3/16 | 30 |

NOTE: Use with mating adapter PN 685RA.

Construction: Steel. Nitrile O-ring.

1WW56 Male Rapid Assembly 45° Elbow

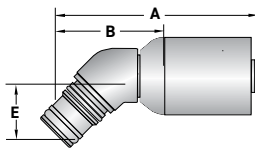

| Part Number | Stem O.D. | | Hose I.D. | | A | | Cutoff Allow. B | | E | |
|-------------|-----------|----|-----------|----|------|----|-----------------|----|------|----|
| | inch | mm | inch | mm | inch | mm | inch | mm | inch | mm |
| 1WW56-4-4 | 1/4 | 6 | 1/4 | 6 | 2.31 | 59 | 1-5/16 | 33 | 0.67 | 17 |
| 1WW56-6-6 | 3/8 | 10 | 3/8 | 10 | 2.35 | 60 | 1-3/8 | 35 | 0.67 | 17 |

NOTE: Use with mating adapter PN 685RA.

Construction: Steel. Nitrile O-ring.

1WY56 Male Rapid Assembly 90° Elbow

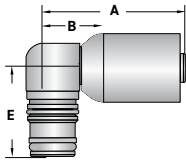

| Part Number | Stem O.D. | | Hose I.D. | | A | | Cutoff Allow. B | | E | |
|-------------|-----------|----|-----------|----|------|----|-----------------|----|------|----|
| | inch | mm | inch | mm | inch | mm | inch | mm | inch | mm |
| 1WY56-4-4 | 1/4 | 6 | 1/4 | 6 | 1.60 | 41 | 5/8 | 16 | 0.90 | 23 |
| 1WY56-6-6 | 3/8 | 10 | 3/8 | 10 | 1.66 | 42 | 5/8 | 16 | 1.01 | 26 |

NOTE: Use with mating adapter PN 685RA.

Construction: Steel. Nitrile O-ring.

685RA Adapter Female Rapid Assembly - Male SAE Straight Thread ORB

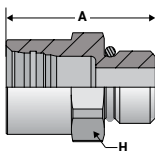

| Part Number | Stem O.D. | | Thread Size | A | | H Hex |
|-------------|-----------|----|-------------|------|----|-------|
| | inch | mm | | inch | mm | inch |
| 685RA-4-4 | 1/4 | 6 | 7/16-20 | 1.05 | 27 | 11/16 |
| 685RA-6-4 | 3/8 | 10 | 7/16-20 | 1.15 | 29 | 3/4 |
| 685RA-4-6 | 1/4 | 6 | 9/16-18 | 1.12 | 28 | 3/4 |
| 685RA-6-6 | 3/8 | 10 | 9/16-18 | 1.15 | 29 | 3/4 |







Construction: Steel. Nitrile O-ring.

WARNING

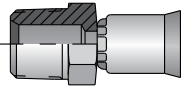
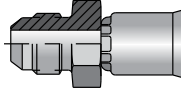
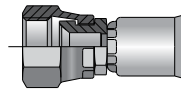
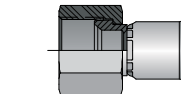
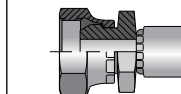
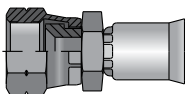
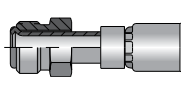
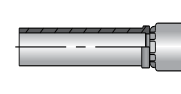
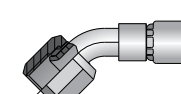
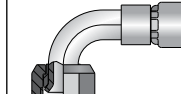
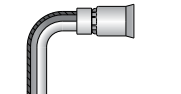
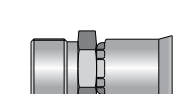
This product can expose you to chemicals including Lead, which is known to the State of California to cause cancer and birth defects or other reproductive harm. For more information go to www.P65Warnings.ca.gov.

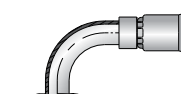
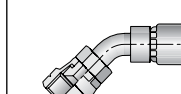
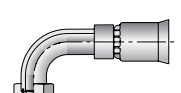
Fittings - Permanent Crimp

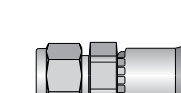
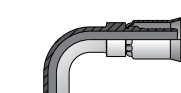
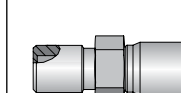
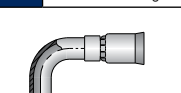
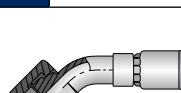
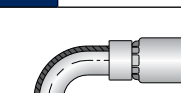
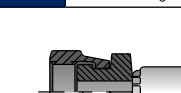
91N Series

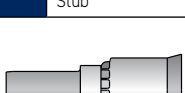
| | | | | | |
|---|---|---|---|---|---|
| 91 Series Permanent | 101 Male Taper Pipe Rigid | 103 Male JIC 37° | 106 JIC 37° Female Swivel | 106RD SAE JIC 37° Swivel | 107 Female Pipe Swivel |
| |  E-52 |  E-52 |  E-52 |  E-53 |  E-53 |
| | 108 Female SAE 45° Swivel | 128 Male Inverted Swivel Straight | 134 Straight Tube | 137 Female JIC 37° Swivel 45° Elbow | 139 FM JIC 37° Swivel 90° Elbow Short |
| |  E-53 |  E-54 |  E-54 |  E-54 |  E-55 |
| | 141 Female JIC 37° Swivel 90° Elb Long | 161 Compression Air Brake | 167 Male Inverted Swivel 45° Elbow | 169 Male Inverted Swivel 90° Elbow | 177 SAE 45° Swivel 45° Elbow |
| |  E-55 |  E-55 |  E-56 |  E-56 |  E-56 |
| | 179 SAE 45° Swivel 90° Elbow | 192 FM BSP Pipe Swivel - Str. (60° Cone) | 1AL A-Lok® Compression | 1B2 FM BSP Pipe Swivel 90° Elb. (60° Cone) | 1GK Bulkhead w/Zerk Port Integrated |
| |  E-57 |  E-60 |  E-57 |  E-60 |  E-60 |
| | 1J1 Female Seal-Lok™ 90° Elbow Long | 1J7 Female Seal-Lok™ 45° Elbow | 1J9 Female Seal-Lok™ 90° Elbow Short | 1JC Female Seal-Lok™ Swivel Straight | 1P6 CPI® Compression w/nut and ferrule |
| |  E-58 |  E-58 |  E-59 |  E-59 |  E-57 |
| 1TU Universal Tube Stub | | | | | |
|  E-59 | | | | | |

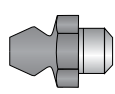
| | | |
|---------------------------------|---|---|
| 1GK91N Options | Nut 2GK-Nut | Zerk NA-6520 |
| |  E-60 |  E-60 |

WARNING

This product can expose you to chemicals including Lead, which is known to the State of California to cause cancer and birth defects or other reproductive harm. For more information go to www.P65Warnings.ca.gov.

Fittings - Permanent Crimp

91N Series

10191N Male Taper Pipe Rigid

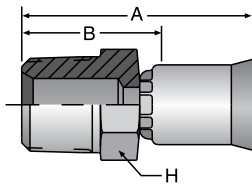

Construction: Brass nipple, steel shell.
Add "C" for Stainless Steel.

| Part Number | Thread Size | Hose Size inch | A | | Cutoff Allow. B | | H Hex inch |
|--------------|--------------|-------------------|------|----|--------------------|----|------------------|
| | | | inch | mm | inch | mm | |
| 10191N-2-4 | 1/8-27 | -4 | 1.27 | 32 | 3/4 | 19 | 7/16 |
| 10191N-4-4 | 1/4-18 | -4 | 1.50 | 38 | 15/16 | 24 | 9/16 |
| 10191N-4-5 | 1/4-18 | -5 | 1.55 | 39 | 15/16 | 24 | 9/16 |
| 10191N-4-6 | 1/4-18 | -6 | 1.60 | 41 | 15/16 | 24 | 9/16 |
| 10191N-6-6 | 3/8-18 | -6 | 1.65 | 58 | 1 | 25 | 11/16 |
| 10191N-6-8 | 3/8-18 | -8 | 1.71 | 43 | 1 | 25 | 11/16 |
| 10191N-8-8 | 1/2-14 | -8 | 1.94 | 49 | 1-1/4 | 32 | 7/8 |
| 10191N-8-10 | 1/2-14 | -10 | 1.96 | 50 | 1-1/4 | 32 | 7/8 |
| 10191N-8-12 | 1/2-14 | -12 | 2.42 | 61 | 1-1/4 | 32 | 1 |
| 10191N-12-12 | 3/4-14 | -12 | 2.19 | 56 | 1-3/8 | 35 | 1-1/8 |
| 10191N-16-16 | 1-11-1/2 | -16 | 2.46 | 62 | 1-1/2 | 38 | 1-3/8 |
| 10191-20-20 | 1-1/4-11-1/2 | -20 | 3.05 | 77 | 2-1/16 | 52 | 1-3/4 |

10391N Male (JIC) 37°

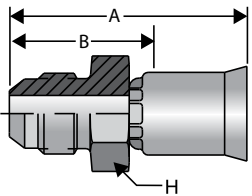

Construction: Steel nipple, steel shell.
Add "C" for Stainless Steel.

| Part Number | Thread Size | Hose Size inch | A | | Cutoff Allow. B | | H Hex inch |
|--------------|-------------|-------------------|------|----|--------------------|----|------------------|
| | | | inch | mm | inch | mm | |
| 10391N-4-4 | 7/16-20 | -4 | 1.37 | 35 | 13/16 | 21 | 1/2 |
| 10391N-6-6 | 9/16-18 | -6 | 1.64 | 42 | 1 | 25 | 11/16 |
| 10391N-8-8 | 3/4-16 | -8 | 1.79 | 35 | 1-1/8 | 29 | 7/8 |
| 10391N-8-6 | 3/4-16 | -6 | 1.73 | 44 | 1-1/16 | 27 | 7/8 |
| 10391N-10-10 | 7/8-14 | -10 | 2.07 | 53 | 1-3/8 | 35 | 1 |
| 10391N-12-12 | 1-1/16-12 | -12 | 2.10 | 53 | 1-5/16 | 33 | 1-1/8 |
| 10391N-16-16 | 1-5/16-12 | -16 | 2.43 | 62 | 1-1/2 | 38 | 1-3/8 |

10691N Female SAE (JIC) 37° Swivel

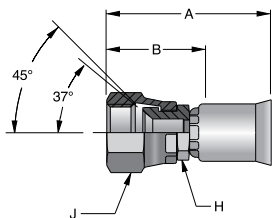

Construction: Brass nipple, steel nut and shell. Add "S" for Steel nipple, nut and shell. Add "C" for Stainless Steel.

| Part Number | Thread Size | Hose Size inch | A | | Cutoff Allow. B | | H Hex inch | J Hex inch |
|--------------|-------------|-------------------|------|----|--------------------|----|------------------|------------------|
| | | | inch | mm | inch | mm | | |
| 10691N-4-4 | 7/16-20 | -4 | 1.47 | 37 | 7/8 | 22 | 3/8 | 9/16 |
| 10691N-5-5 | 1/2-20 | -5 | 1.60 | 41 | 1 | 25 | 7/16 | 5/8 |
| 10691N-6-6 | 9/16-18 | -6 | 1.66 | 42 | 1 | 25 | 1/2 | 11/16 |
| 10691N-6-8 | 9/16-18 | -8 | 1.72 | 44 | 1 | 25 | 9/16 | 11/16 |
| 10691N-8-8 | 3/4-16 | -8 | 1.89 | 48 | 1-3/16 | 30 | 11/16 | 7/8 |
| 10691N-8-10 | 3/4-16 | -10 | 1.86 | 58 | 1-1/8 | 29 | 3/4 | 7/8 |
| 10691N-10-10 | 7/8-14 | -10 | 2.03 | 52 | 1-5/16 | 33 | 13/16 | 1 |
| 10691N-12-12 | 1-1/16-12 | -12 | 2.18 | 55 | 1-3/8 | 35 | 1 | 1-1/4 |
| 10691N-16-16 | 1-5/16-12 | -16 | 2.45 | 62 | 1-9/16 | 40 | 1-1/4 | 1-1/2 |
| 10691-20-20 | 1-5/8-12 | -20 | 2.58 | 65 | 1-9/16 | 40 | 1-11/16 | 2 |

NOTE: Size -4, -5, -8 and -10 incorporate a dual seat.

WARNING

This product can expose you to chemicals including Lead, which is known to the State of California to cause cancer and birth defects or other reproductive harm. For more information go to www.P65Warnings.ca.gov.

Fittings - Permanent Crimp

91N Series

10691NRD SAE (JIC) 37° Swivel

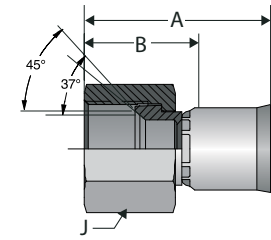

Construction: Brass nipple, steel nut and shell. Add "C" for Stainless Steel.

| Part Number | Thread Size | Hose Size inch | A | | Cutoff Allow. B | | J Hex inch |
|-----------------|-------------|-------------------|------|----|--------------------|----|------------------|
| | | | inch | mm | inch | mm | |
| 10691N-4-4-RD | 7/16-20 | -4 | 1.34 | 34 | 13/16 | 21 | 9/16 |
| 10691N-5-5-RD | 1/2-20 | -5 | 1.52 | 39 | 15/16 | 24 | 5/8 |
| 10691N-6-6-RD | 9/16-18 | -6 | 1.61 | 41 | 1 | 25 | 11/16 |
| 10691N-8-8-RD | 3/4-16 | -8 | 1.77 | 45 | 1-1/16 | 27 | 7/8 |
| 10691N-10-10-RD | 7/8-14 | -10 | 1.91 | 49 | 1-3/16 | 30 | 1 |
| 10691N-12-12-RD | 1-1/16-12 | -12 | 2.09 | 52 | 1-5/16 | 33 | 1-1/4 |
| 10691N-16-16-RD | 1-5/16-12 | -16 | 2.30 | 58 | 1-3/8 | 35 | 1-1/2 |

NOTE: Size -4, -5, -8 and -10 incorporate a dual seat.

10791N Female Pipe Swivel

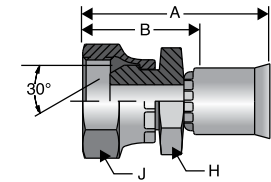

Construction: Brass nipple, steel nut and shell. Add "C" for Stainless Steel.

| Part Number | Thread Size | Hose Size inch | A | | Cutoff Allow. B | | H Hex inch | J Hex inch |
|--------------|-------------|-------------------|------|----|--------------------|----|------------------|------------------|
| | | | inch | mm | inch | mm | | |
| 10791N-4-4 | 1/4-18 | -4 | 1.54 | 39 | 1 | 25 | 9/16 | 11/16 |
| 10791N-6-6 | 3/8-18 | -6 | 1.59 | 40 | 15/16 | 24 | 5/8 | 7/8 |
| 10791N-8-8 | 1/2-14 | -8 | 1.83 | 46 | 1-1/8 | 29 | 3/4 | 1 |
| 10791N-12-12 | 3/4-14 | -12 | 2.09 | 53 | 1-5/16 | 33 | 1 | 1-1/4 |
| 10791N-16-16 | 1-11-1/2 | -16 | 2.35 | 59 | 1-7/16 | 33 | 1-3/16 | 1-1/2 |

10891N SAE 45° Swivel

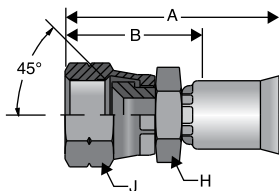

Construction: Brass nipple, steel nut and shell. Add "C" for Stainless Steel.

| Part Number | Thread Size | Hose Size inch | A | | Cutoff Allow. B | | H Hex inch | J Hex inch |
|--------------|-------------|-------------------|------|----|--------------------|----|------------------|------------------|
| | | | inch | mm | inch | mm | | |
| 10891N-6-6 | 5/8-18 | -6 | 1.74 | 44 | 1-1/8 | 29 | 5/8 | 3/4 |
| 10891N-12-12 | 1-1/16-14 | -12 | 2.18 | 55 | 1-3/8 | 35 | 1 | 1-1/4 |



WARNING

This product can expose you to chemicals including Lead, which is known to the State of California to cause cancer and birth defects or other reproductive harm. For more information go to www.P65Warnings.ca.gov.

Fittings - Permanent Crimp

91N Series

A Hose

12891N Male Inverted Swivel-Straight

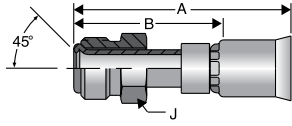

Construction: Steel nipple, tube, nut and shell. Add "C" for Stainless Steel.

| Part Number | Thread Size | Hose Size inch | A | | Cutoff Allow. B | | J Hex inch |
|--------------|-------------|-------------------|------|----|--------------------|----|------------------|
| | | | inch | mm | inch | mm | |
| 12891N-4-4 | 7/16-24 | -4 | 2.09 | 53 | 1-1/2 | 38 | 7/16 |
| 12891N-5-5 | 1/2-20 | -5 | 2.15 | 55 | 1-9/16 | 40 | 1/2 |
| 12891N-5-6 | 1/2-20 | -6 | 2.23 | 57 | 1-9/16 | 40 | 1/2 |
| 12891N-6-6 | 5/8-18 | -6 | 2.23 | 57 | 1-9/16 | 40 | 5/8 |
| 12891N-8-8 | 3/4-18 | -8 | 2.31 | 59 | 1-5/8 | 41 | 3/4 |
| 12891N-10-10 | 7/8-18 | -10 | 2.43 | 58 | 1-3/4 | 44 | 7/8 |
| 12891N-12-12 | 1-1/16-16 | -12 | 2.50 | 64 | 1-11/16 | 43 | 1-1/16 |

B Tubing
Thermoplastic

C Coiled Air Hose
& Fittings

13491N Straight Tube

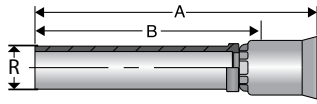

Construction: Brass nipple, steel shell.

| Part Number | Hose Size | Diameter R inch | A | | Cutoff Allow. B | |
|--------------|-----------|-----------------------|------|----|--------------------|----|
| | | | inch | mm | inch | mm |
| 13491N-8-8 | -8 | 1/2 | 2.80 | 71 | 2-1/8 | 54 |
| 13491N-8-10 | -10 | 1/2 | 2.81 | 71 | 2-1/8 | 54 |
| 13491N-10-10 | -10 | 5/8 | 2.96 | 75 | 2-1/4 | 58 |
| 13491N-12-12 | -12 | 3/4 | 3.37 | 86 | 2-9/16 | 65 |

NOTE: The 16T91N fitting includes 13491N with the 60HAB sleeve and 61HAB nut.

D Transportation

E Fittings

13791N JIC 37° Swivel 45° Elbow

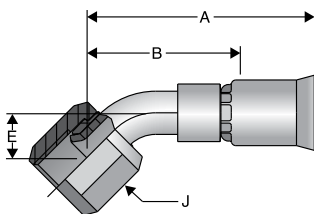

Construction: Steel nipple, tube, nut and shell. Add "C" for Stainless Steel.

| Part Number | Thread Size | Hose Size inch | A | | Cutoff Allow. B | | E | | J Hex inch |
|--------------|-------------|-------------------|------|----|--------------------|----|------|----|------------------|
| | | | inch | mm | inch | mm | inch | mm | |
| 13791N-4-4 | 7/16-20 | -4 | 1.74 | 44 | 1-3/16 | 30 | 0.33 | 8 | 9/16 |
| 13791N-5-5 | 1/2-20 | -5 | 1.87 | 47 | 1-1/4 | 32 | 0.36 | 9 | 5/8 |
| 13791N-6-6 | 9/16-18 | -6 | 1.94 | 49 | 1-5/16 | 33 | 0.43 | 11 | 11/16 |
| 13791N-8-8 | 3/4-16 | -8 | 2.28 | 58 | 1-9/16 | 37 | 0.55 | 14 | 7/8 |
| 13791N-10-10 | 7/8-14 | -10 | 2.42 | 61 | 1-11/16 | 43 | 0.64 | 43 | 1 |
| 13791N-12-12 | 1-1/16-12 | -12 | 2.83 | 58 | 2-1/16 | 52 | 0.78 | 20 | 1-1/4 |
| 13791N-16-16 | 1-5/16-12 | -16 | 3.18 | 81 | 2-1/4 | 57 | 0.89 | 23 | 1-1/2 |
| 13791N-20-20 | 1-5/8-12 | -20 | 3.67 | 93 | 2-9/16 | 65 | 1.10 | 28 | 2 |

WARNING

This product can expose you to chemicals including Lead, which is known to the State of California to cause cancer and birth defects or other reproductive harm. For more information go to www.P65Warnings.ca.gov.

F Tooling, Equipment,
& Accessories

G General Technical

Fittings - Permanent Crimp

91N Series

13991N JIC 37° Swivel 90° Elbow Short Drop

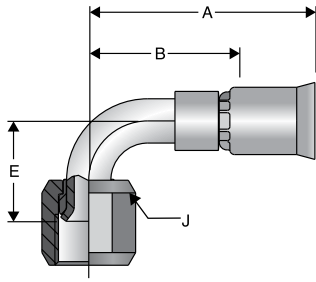

Construction: Steel nipple, tube, nut and shell. Add "C" for Stainless Steel.

| Part Number | Thread Size | Hose Size inch | A | | Cutoff Allow. B | | E | | J Hex inch |
|--------------|-------------|-------------------|------|----|-----------------|----|------|----|---------------|
| | | | inch | mm | inch | mm | inch | mm | |
| 13991N-4-4 | 7/16-20 | -4 | 1.62 | 41 | 1-1/16 | 37 | 0.68 | 17 | 9/16 |
| 13991N-5-5 | 1/2-20 | -5 | 1.73 | 44 | 1-1/8 | 29 | 0.77 | 20 | 5/8 |
| 13991N-6-6 | 9/16-18 | -6 | 1.91 | 49 | 1-1/4 | 32 | 0.91 | 23 | 11/16 |
| 13991N-8-8 | 3/4-16 | -8 | 2.03 | 52 | 1-5/16 | 33 | 1.09 | 28 | 7/8 |
| 13991N-10-10 | 7/8-14 | -10 | 2.27 | 58 | 1-9/16 | 37 | 1.23 | 43 | 1 |
| 13991N-12-12 | 1-1/16-12 | -12 | 2.75 | 58 | 1-15/16 | 49 | 1.82 | 46 | 1-1/2 |
| 13991N-16-16 | 1-5/16-12 | -16 | 3.15 | 80 | 2-3/16 | 56 | 2.14 | 52 | 1-1/2 |
| 13991-20-20 | 1-5/8-12 | -20 | 3.53 | 90 | 2-7/16 | 62 | 1.18 | 30 | 2 |

14191N JIC 37° Swivel 90° Elbow Long Drop

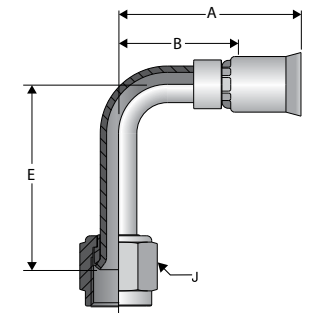

Construction: Steel nipple, tube, nut and shell. Add "C" for Stainless Steel.

| Part Number | Thread Size | Hose Size inch | A | | Cutoff Allow. B | | E | | J Hex inch |
|--------------|-------------|-------------------|------|-----|-----------------|----|------|-----|---------------|
| | | | inch | mm | inch | mm | inch | mm | |
| 14191N-4-4 | 7/16-20 | -4 | 1.66 | 42 | 1-1/8 | 29 | 1.80 | 46 | 9/16 |
| 14191N-5-5 | 1/2-20 | -5 | 1.72 | 44 | 1-1/8 | 29 | 1.77 | 45 | 5/8 |
| 14191N-6-6 | 9/16-18 | -6 | 1.93 | 49 | 1-5/16 | 33 | 2.13 | 54 | 11/16 |
| 14191N-8-8 | 3/4-16 | -8 | 2.11 | 54 | 1-3/8 | 35 | 2.52 | 64 | 7/8 |
| 14191N-10-10 | 7/8-14 | -10 | 2.34 | 59 | 1-5/8 | 41 | 2.57 | 65 | 1 |
| 14191N-12-12 | 1-1/16-12 | -12 | 2.63 | 67 | 1-7/8 | 48 | 3.73 | 95 | 1-1/4 |
| 14191N-16-16 | 1-5/16-12 | -16 | 3.15 | 80 | 2-3/16 | 56 | 4.33 | 110 | 1-1/2 |
| 14191-20-20 | 1-5/8-12 | -20 | 4.00 | 102 | 2-15/16 | 75 | 5.28 | 134 | 2 |

16191N Compression Air Brake

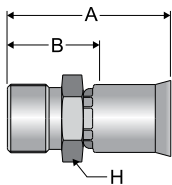

Construction: Brass nipple, steel shell.

| Part Number | Thread Size | Hose Size inch | A | | Cutoff Allow. B | | H Hex inch |
|--------------|-------------|-------------------|------|----|-----------------|----|---------------|
| | | | inch | mm | inch | mm | |
| 16191N-8-8 | 11/16-20 | -8 | 1.63 | 41 | 15/16 | 24 | 3/4 |
| 16191N-8-10 | 11/16-20 | -10 | 1.65 | 42 | 15/16 | 24 | 3/4 |
| 16191N-10-10 | 13/16-18 | -10 | 1.82 | 46 | 1-1/8 | 29 | 15/16 |
| 16191N-12-12 | 1-18 | -12 | 1.97 | 50 | 1-3/16 | 30 | 1-1/8 |



WARNING

This product can expose you to chemicals including Lead, which is known to the State of California to cause cancer and birth defects or other reproductive harm. For more information go to www.P65Warnings.ca.gov.

Fittings - Permanent Crimp

91N Series

16791N Male Inverted Swivel 45° Elbow

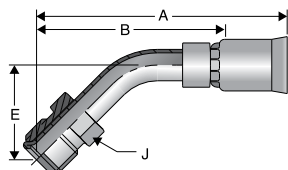

Construction: Steel nipple, tube, nut and shell. Add "C" for Stainless Steel.

| Part Number | Thread Size | Hose Size inch | A | | Cutoff Allow. B | | E | | J Hex inch |
|--------------|-------------|-------------------|------|----|-----------------|----|------|----|------------------|
| | | | inch | mm | inch | mm | inch | mm | |
| 16791N-4-4 | 7/16-24 | -4 | 2.05 | 52 | 1-1/2 | 38 | 0.63 | 16 | 7/16 |
| 16791N-5-5 | 1/2-20 | -5 | 2.48 | 63 | 1-7/8 | 48 | 0.71 | 18 | 1/2 |
| 16791N-6-6 | 5/8-18 | -6 | 2.60 | 66 | 1-15/16 | 49 | 0.96 | 24 | 5/8 |
| 16791N-8-8 | 3/4-18 | -8 | 2.85 | 72 | 2-1/8 | 54 | 0.90 | 23 | 3/4 |
| 16791N-10-10 | 7/8-18 | -10 | 3.30 | 84 | 2-5/8 | 67 | 1.02 | 43 | 7/8 |
| 16791N-12-12 | 1-1/16-16 | -12 | 3.64 | 58 | 2-13/16 | 71 | 1.15 | 29 | 1-1/16 |

16991N Male Inverted Swivel 90° Elbow

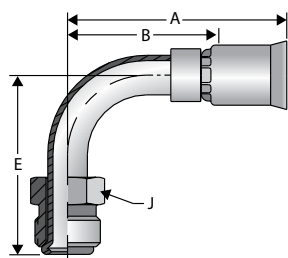

Construction: Steel nipple, tube, nut and shell. Add "C" for Stainless Steel.

| Part Number | Thread Size | Hose Size inch | A | | Cutoff Allow. B | | E | | J Hex inch |
|--------------|-------------|-------------------|------|----|-----------------|----|------|----|------------------|
| | | | inch | mm | inch | mm | inch | mm | |
| 16991N-4-4 | 7/16-24 | -4 | 1.72 | 44 | 1-3/16 | 30 | 1.19 | 30 | 7/16 |
| 16991N-5-5 | 1/2-20 | -5 | 1.98 | 50 | 1-3/8 | 35 | 1.65 | 42 | 1/2 |
| 16991N-5-6 | 1/2-20 | -6 | 2.03 | 52 | 1-7/16 | 37 | 1.65 | 42 | 1/2 |
| 16991N-6-6 | 5/8-18 | -6 | 2.08 | 53 | 1-7/16 | 37 | 1.70 | 43 | 5/8 |
| 16991N-8-8 | 3/4-18 | -8 | 2.18 | 55 | 1-1/2 | 38 | 1.87 | 43 | 3/4 |
| 16991N-10-10 | 7/8-18 | -10 | 3.02 | 58 | 2-5/16 | 59 | 2.18 | 55 | 7/8 |
| 16991N-12-12 | 1-1/16-16 | -12 | 3.36 | 85 | 2-9/16 | 64 | 2.51 | 64 | 1-1/16 |

17791N SAE 45° Swivel 45° Elbow

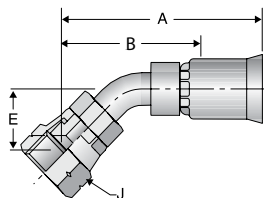

Construction: Steel nipple, tube, nut and shell. Add "C" for Stainless Steel.

| Part Number | Thread Size | Hose Size inch | A | | Cutoff Allow. B | | E | | J Hex inch |
|--------------|-------------|-------------------|------|----|-----------------|----|------|----|------------------|
| | | | inch | mm | inch | mm | inch | mm | |
| 17791N-6-6 | 5/8-18 | 3/8 | 2.06 | 52 | 1-5/16 | 33 | 0.39 | 10 | 3/4 |
| 17791N-12-12 | 1-1/16-14 | 3/4 | 3.07 | 78 | 2-7/16 | 62 | 0.78 | 20 | 1-1/4 |



WARNING

This product can expose you to chemicals including Lead, which is known to the State of California to cause cancer and birth defects or other reproductive harm. For more information go to www.P65Warnings.ca.gov.

Fittings - Permanent Crimp

91N Series

17991N SAE 45° Swivel 90° Elbow

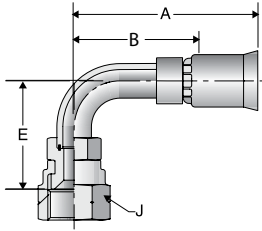

Construction: Steel nipple, tube, nut and shell. Add "C" for Stainless Steel.

| Part Number | Thread Size | Hose Size inch | A | | Cutoff Allow. B | | E | | J Hex inch |
|--------------|-------------|-------------------|------|----|--------------------|----|------|----|------------------|
| | | | inch | mm | inch | mm | inch | mm | inch |
| 17991N-6-6 | 5/8-18 | 3/8 | 2.06 | 52 | 1-5/16 | 49 | 1.19 | 30 | 3/4 |
| 17991N-12-12 | 1-1/16-14 | 3/4 | 2.92 | 74 | 2-1/8 | 54 | 1.82 | 46 | 1-1/4 |

1AL91N A-LOK® Compression

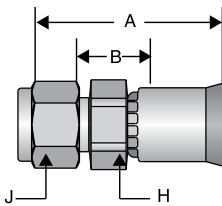

Construction: Stainless steel nipple and shell.

| Part Number w/nut & ferrule | Part Number w/o nut & ferrules | Hose Size inch | A | | Cutoff Allow. B | | H Hex inch | J Hex inch |
|--------------------------------|-----------------------------------|-------------------|------|----|--------------------|----|------------------|------------------|
| | | | inch | mm | inch | mm | inch | inch |
| 1AL91N-4-4C | 1AL91N-4-4NC | -4 | 1.28 | 33 | 7/16 | 11 | 1/2 | 9/16 |
| 1AL91N-4-5C | 1AL91N-4-5NC | -5 | 1.36 | 35 | 7/16 | 11 | 1/2 | 9/16 |
| 1AL91N-6-6C | 1AL91N-6-6NC | -6 | 1.46 | 37 | 7/16 | 11 | 3/4 | 11/16 |
| 1AL91N-8-8C | 1AL91N-8-8NC | -8 | 1.61 | 41 | 7/16 | 11 | 13/16 | 7/8 |
| 1AL91N-12-12C | 1AL91N-12-12NC | -12 | 1.86 | 47 | 1/2 | 13 | 1-1/8 | 1-1/8 |
| 1AL91N-16-16C | 1AL91N-16-16NC | -16 | 2.12 | 54 | 7/16 | 11 | 1-3/8 | 1-1/2 |

NOTE: Nuts and Ferrules are Manufactured by the Instrumentation Products Division. Refer to Catalog 4230/4233 for information.
Nut part No. is XNUX-316. Ferrule part No. is XFFX-316. X denotes dash size.

1P691N CPI® Compression (With Nut and Ferrule)

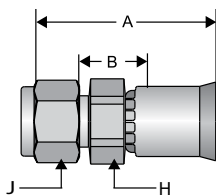

Construction: Stainless steel nipple and shell.

| Part Number w/nut & ferrule | Hose Size inch | A | | Cutoff Allow. B | | H Hex inch | J Hex inch |
|--------------------------------|-------------------|------|----|-----------------|----|------------------|------------------|
| | | inch | mm | inch | mm | inch | inch |
| 1P691N-4-4C | -4 | 1.30 | 33 | 7/16 | 11 | 1/2 | 9/16 |
| 1P691N-6-6C | -6 | 1.53 | 39 | 1/2 | 13 | 5/8 | 11/16 |
| 1P691N-8-8C | -8 | 1.61 | 41 | 7/16 | 11 | 13/16 | 7/8 |

NOTE: Nuts and Ferrules are Manufactured by the Instrumentation Products Division. Refer to Catalog 4230/4233 for information.
Nut part No. is XBZ-SS. Ferrule part No. is XTZ-SS. X denotes dash size.

WARNING

This product can expose you to chemicals including Lead, which is known to the State of California to cause cancer and birth defects or other reproductive harm. For more information go to www.P65Warnings.ca.gov.

Fittings - Permanent Crimp

91N Series

1J191N Female Seal-Lok™ Swivel 90° Elbow Long Drop

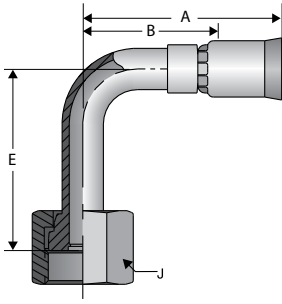

Construction: Steel nipple, tube, nut and shell. Add "C" for Stainless Steel.

| Part Number | Thread Size | Hose Size inch | A | | Cutoff Allow. B | | E | | J Hex inch |
|--------------|-------------|-------------------|------|----|--------------------|----|------|-----|------------------|
| | | | inch | mm | inch | mm | inch | mm | |
| 1J191N-4-4 | 9/16-18 | -4 | 1.66 | 42 | 1-1/16 | 27 | 1.8 | 46 | 11/16 |
| 1J191N-4-5 | 9/16-18 | -5 | 1.78 | 45 | 1-1/16 | 27 | 1.8 | 46 | 11/16 |
| 1J191N-6-5 | 11/16-16 | -5 | 1.92 | 49 | 1-3/16 | 30 | 2.13 | 54 | 13/16 |
| 1J191N-6-6 | 11/16-16 | -6 | 1.92 | 49 | 1-3/16 | 30 | 2.13 | 54 | 13/16 |
| 1J191N-8-6 | 13/16-16 | -6 | 2 | 51 | 1-9/16 | 40 | 2.51 | 43 | 15/16 |
| 1J191N-8-8 | 13/16-16 | -8 | 2.15 | 58 | 1-7/16 | 37 | 2.51 | 64 | 15/16 |
| 1J191N-10-10 | 1-14 | -10 | 1.25 | 32 | 1-9/16 | 40 | 2.76 | 70 | 1-1/8 |
| 1J191N-12-12 | 1-3/16-12 | -12 | 2.65 | 67 | 1-13/16 | 46 | 3.78 | 96 | 1-3/8 |
| 1J191N-16-16 | 1-7/16-12 | -16 | 3.15 | 80 | 2-1/4 | 57 | 4.5 | 114 | 1-1/2 |

1J791N Female Seal-Lok™ Swivel 45° Elbow

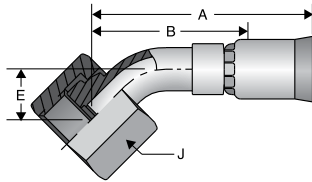

Construction: Steel nipple, tube, nut and shell. Add "C" for Stainless Steel.

| Part Number | Thread Size | Hose Size inch | A | | Cutoff Allow. B | | E | | J Hex inch |
|--------------|-------------|-------------------|------|----|--------------------|----|------|----|------------------|
| | | | inch | mm | inch | mm | inch | mm | |
| 1J791N-4-4 | 9/16-18 | -4 | 1.73 | 44 | 1-1/4 | 32 | 0.41 | 10 | 11/16 |
| 1J791N-4-6 | 9/16-18 | -6 | 1.91 | 49 | 1-5/16 | 33 | 0.41 | 10 | 11/16 |
| 1J791N-6-6 | 11/16-16 | -6 | 2.02 | 51 | 1-3/8 | 35 | 0.43 | 11 | 13/16 |
| 1J791N-8-8 | 13/16-16 | -8 | 2.18 | 55 | 1-1/2 | 38 | 0.59 | 15 | 15/16 |
| 1J791N-8-10 | 13/16-16 | -10 | 2.39 | 61 | 1-11/16 | 43 | 0.59 | 15 | 15/16 |
| 1J791N-10-10 | 1-14 | -10 | 2.47 | 63 | 1-3/4 | 44 | 0.59 | 43 | 1-1/8 |
| 1J791N-12-12 | 1-3/16-12 | -12 | 2.74 | 58 | 1-15/16 | 49 | 0.81 | 21 | 1-3/8 |
| 1J791N-16-16 | 1-7/16-12 | -16 | 3.50 | 89 | 2-1/2 | 64 | 0.94 | 24 | 1-5/8 |

WARNING

This product can expose you to chemicals including Lead, which is known to the State of California to cause cancer and birth defects or other reproductive harm. For more information go to www.P65Warnings.ca.gov.

Fittings - Permanent Crimp

91N Series

1J991N Female Seal-Lok™ Swivel 90° Elbow Short Drop

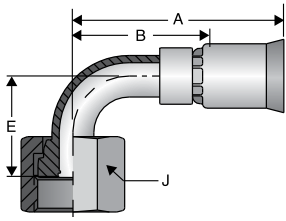

Construction: Steel nipple, tube, nut and shell. Add "C" for Stainless Steel.

| Part Number | Thread Size | Hose Size inch | A | | Cutoff Allow. B | | E | | J Hex inch |
|--------------|-------------|-------------------|------|----|--------------------|----|------|----|------------------|
| | | | inch | mm | inch | mm | inch | mm | |
| 1J991N-4-4 | 9/16-18 | -4 | 1.73 | 44 | 1-1/4 | 32 | 0.82 | 21 | 11/16 |
| 1J991N-6-6 | 11/16-16 | -6 | 1.91 | 49 | 1-5/16 | 33 | 0.91 | 23 | 13/16 |
| 1J991N-8-8 | 13/16-16 | -8 | 2.02 | 51 | 1-3/8 | 35 | 1.15 | 29 | 15/16 |
| 1J991N-10-10 | 1-14 | -10 | 2.18 | 55 | 1-1/2 | 38 | 1.27 | 32 | 1-1/8 |
| 1J991N-12-12 | 1-3/16-12 | -12 | 2.39 | 61 | 1-11/16 | 43 | 1.85 | 43 | 1-3/8 |
| 1J991N-16-16 | 1-7/16-12 | -16 | 2.47 | 63 | 1-3/4 | 44 | 2.21 | 56 | 1-5/8 |

1JC91N Female Seal-Lok™ Swivel Straight

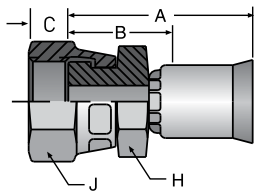

Construction: Steel nipple, tube, nut and shell. Add "C" for Stainless Steel.

| Part Number | Thread Size | Hose Size inch | A | | Cutoff Allow. B | | C | | H Hex inch | J Hex inch |
|--------------|-------------|-------------------|------|----|-----------------|----|------|----|------------------|------------------|
| | | | inch | mm | inch | mm | inch | mm | | |
| 1JC91N-4-4 | 9/16-18 | 4 | 1.16 | 30 | 5/8 | 16 | 0.31 | 8 | 9/16 | 7/16 |
| 1JC91N-6-6 | 11/16-16 | 6 | 1.32 | 33 | 11/16 | 17 | 0.35 | 9 | 5/8 | 13/16 |
| 1JC91N-8-8 | 13/16-16 | 8 | 1.49 | 38 | 13/16 | 20 | 0.43 | 11 | 3/4 | 15/16 |
| 1JC91N-12-10 | 1-14 | 10 | 1.59 | 40 | 7/8 | 22 | 0.48 | 12 | 15/16 | 1-1/8 |
| 1JC91N-12-12 | 1-3/16-12 | 12 | 1.73 | 44 | 15/16 | 24 | 0.55 | 14 | 1-1/4 | 1-3/8 |
| 1JC91N-16-16 | 1-7/16-12 | 16 | 2.00 | 51 | 1-1/16 | 27 | 0.57 | 14 | 1-3/8 | 1-5/8 |
| 1JC91N-20-16 | 1-11/16-12 | 16 | 1.99 | 51 | 1-1/16 | 27 | 0.59 | 15 | 1-5/8 | 1-7/8 |
| 1JC91-20-20 | 1-11/16-12 | 20 | 1.89 | 48 | 7/8 | 22 | 0.59 | 15 | 1-11/16 | 1-7/8 |

NOTE: When measuring overall length to the end of the nut, B+C dimensions must be used to calculate cut-off allowance.

1TU91N Universal Tube Stub

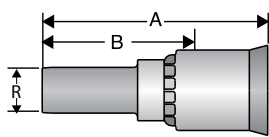

Construction: Stainless steel tube and shell.

| Part Number | Hose Size | Diameter R inch | A | | Cutoff Allow. B | |
|---------------|-----------|-----------------------|------|----|--------------------|----|
| | | | inch | mm | inch | mm |
| 1TU91N-4-4C | -4 | 1/4 | 1.63 | 41 | 1-1/16 | 27 |
| 1TU91N-4-5C | -5 | 1/4 | 1.70 | 43 | 1-1/16 | 27 |
| 1TU91N-6-6C | -6 | 3/8 | 1.81 | 46 | 1-3/16 | 30 |
| 1TU91N-8-8C | -8 | 1/2 | 2.72 | 58 | 1-7/16 | 37 |
| 1TU91N-8-10C | -10 | 1/2 | 2.14 | 54 | 1-7/16 | 37 |
| 1TU91N-10-10C | -10 | 5/8 | 2.14 | 54 | 1-7/16 | 37 |
| 1TU91N-12-12C | -12 | 3/4 | 2.24 | 57 | 1-7/16 | 37 |
| 1TU91N-16-16C | -16 | 1 | 2.73 | 69 | 1-3/4 | 44 |

NOTE: Use with A-Lok & CPI nuts, sleeves and adapters. These components are manufactured by Parker's Instrumentation Connectors Division. Refer to catalog 4230/4233 for information.

WARNING

This product can expose you to chemicals including Lead, which is known to the State of California to cause cancer and birth defects or other reproductive harm. For more information go to www.P65Warnings.ca.gov.

Fittings - Permanent Crimp

91N Series

A Hose

19291N Female BSP Parallel Pipe Swivel Straight (60° Cone)

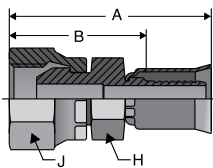

Construction: Steel nipple, tube, nut and shell. Add "C" for Stainless Steel.

| Part Number | Thread Size | Hose Size inch | A | | Cutoff inch | Allow. B mm | H Hex mm | J Hex mm |
|--------------|-------------|-------------------|------|----|----------------|----------------|----------------|----------------|
| | | | inch | mm | | | | |
| 19291N-8-8 | PF-1/2-14 | -8 | 1.99 | 51 | 1-5/16 | 33 | 27 | 27 |
| 19291N-12-12 | PF-3/4-14 | -12 | 2.35 | 60 | 1-9/16 | 40 | 36 | 36 |

B Tubing Thermoplastic

1B291N Female BSP Parallel Pipe Swivel - 90° Elbow (60° Cone)

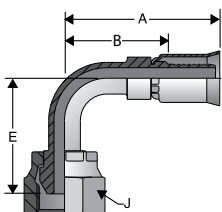

Construction: Steel nipple, tube, nut and shell. Add "C" for Stainless Steel.

| Part Number | Thread Size | Hose Size inch | A | | Cutoff inch | Allow. B mm | E | | J Hex mm |
|--------------|-------------|-------------------|------|----|----------------|----------------|------|----|----------------|
| | | | inch | mm | | | inch | mm | |
| 1B291N-8-8 | PF-1/2-14 | -8 | 2.04 | 52 | 1-3/8 | 35 | 1.57 | 40 | 27 |
| 1B291N-12-12 | PF-3/4-14 | -12 | 2.93 | 74 | 2-1/8 | 54 | 2.54 | 65 | 36 |

C Coiled Air Hose & Fittings

D Transportation

1GK91N Bulkhead with Integrated Zerk Port -Bulkhead Nut and Grease Zerk

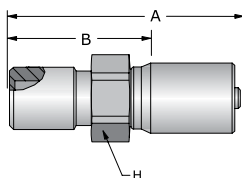

Construction: Steel nipple, tube, nut and shell. Add "C" for Stainless Steel.

| Part Number | Thread Size | Hose Size inch | A | | Cutoff inch | Allow. B mm | H Hex inch |
|-------------|---|-------------------|------|----|----------------|----------------|------------------|
| | | | inch | mm | | | |
| 1GK91N-2-4* | 1/8-27 NPSM Male with 1/4-28 UNF Female | -3 | 1.46 | 37 | 15/16 | 24 | 1/2 |

NOTE: *Long bulkhead for use with plates under 3/4" thick. Uses 2GK-NUT, sold separately.

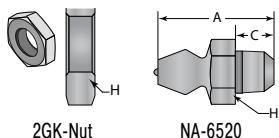

Construction: Steel.

| Part Number | Description | Thread Size | A | | C | | H Hex inch |
|-------------|---------------------|-------------|-------|------|------|-----|------------------|
| | | | inch | mm | inch | mm | |
| 2GK-Nut | Bulkhead Nut | 1/8-27 NPSM | 0.125 | 4.8 | na | na | 9/16 |
| NA-6520 | Grease Zerk Fitting | 1/4-28 UNF | 0.540 | 13.7 | 0.18 | 4.6 | 5/16 |

F Tooling, Equipment, & Accessories



WARNING

This product can expose you to chemicals including Lead, which is known to the State of California to cause cancer and birth defects or other reproductive harm. For more information go to www.P65Warnings.ca.gov.

G General Technical

Fittings - Permanent Crimp

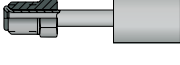
92 Series

| | | | |
|--------------------------------------|---|---|---|
| 92 Series Permanent | 128 SAE Male Inverted Swivel Straight | 167 SAE Male Inverted 45° Elbow | 169 SAE Male Inverted 90° Elbow |
| |  E-61 |  E-61 |  E-61 |

12892 SAE Male Inverted Swivel Straight

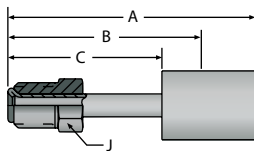

| Part Number | Thread Size | Hose Size | A | | Cutoff Allow. B | | C | | J Hex |
|-------------|-------------|-----------|------|----|-----------------|----|------|----|-------|
| | | | inch | mm | inch | mm | inch | mm | inch |
| 12892-3-3C | 3/8-24 | -3 | 2.01 | 55 | 1-1/2 | 38 | 1.25 | 32 | 7/16 |

Construction: Stainless Steel.

16792 SAE Male Inverted Swivel 45° Elbow

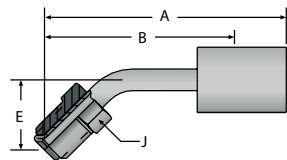

| Part Number | Thread Size | Hose Size | A | | Cutoff Allow. B | | E | | J Hex |
|-------------|-------------|-----------|------|----|-----------------|----|------|----|-------|
| | | | inch | mm | inch | mm | inch | mm | inch |
| 16792-3-3C | 3/8-24 | -3 | 2.36 | 60 | 1-15/16 | 50 | .062 | 16 | 3/8 |

Construction: Stainless Steel.

16992 SAE Male Inverted Swivel 90° Elbow

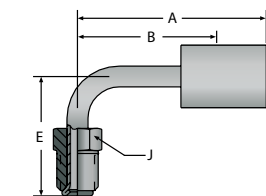

| Part Number | Thread Size | Hose Size | A | | Cutoff Allow. B | | E | | J Hex |
|-------------|-------------|-----------|------|----|-----------------|----|------|----|-------|
| | | | inch | mm | inch | mm | inch | mm | inch |
| 16992-3-3C | 3/8-24 | -3 | 1.45 | 37 | 1 | 25 | 1.25 | 16 | 3/8 |

Construction: Stainless Steel.

WARNING

This product can expose you to chemicals including Lead, which is known to the State of California to cause cancer and birth defects or other reproductive harm. For more information go to www.P65Warnings.ca.gov.

Fittings - Permanent Crimp

93N Series

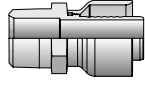
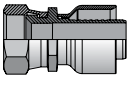
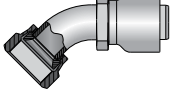
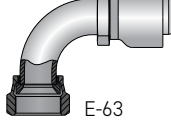
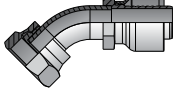
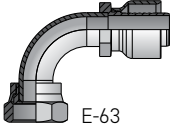
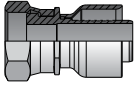
| | | | | | |
|---------------------------------------|---|---|---|---|---|
| 93N Series Permanent | 101 Male Taper Pipe Rigid | 106 Female JIC 37° Swivel | 137 Female JIC 37° Swivel 45° Elbow | 139 Female JIC 37° Swt. 90° Elbow Short | 1J7 Seal-Lok™ 45° Elbow |
| |  E-62 |  E-62 |  E-62 |  E-63 |  E-63 |
| | 1J9 Seal-Lok™ 90° Elbow Short | 1JC Seal-Lok™ Swivel Strt. Short | | | |
| |  E-63 |  E-63 | | | |

10193N Male Taper Pipe Rigid

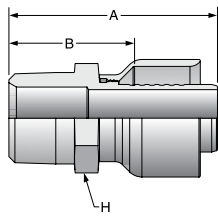

Construction: Steel.
Add "C" for Stainless Steel.

| Part Number | Thread Size | Hose Size | A | | Cutoff Allow. B | | H |
|--------------|--------------|-----------|------|-----|-----------------|----|----------|
| | | | inch | mm | inch | mm | Hex inch |
| 10193N-8-8 | 1/2-14 | -8 | 2.09 | 53 | 1-1/2 | 38 | 7/8 |
| 10193N-12-12 | 3/4-14 | -12 | 2.70 | 69 | 1-5/8 | 41 | 1-1/8 |
| 10193N-16-16 | 1-11-1/2 | -16 | 3.03 | 77 | 1-13/16 | 46 | 1-3/8 |
| 10193N-20-20 | 1-1/4-11-1/2 | -20 | 3.20 | 58 | 1-7/8 | 48 | 1-11/16 |
| 10193N-24-24 | 1-1/2-11-1/2 | -24 | 3.76 | 96 | 2-1/16 | 52 | 2 |
| 10193N-32-32 | 2-11-1/2 | -32 | 3.97 | 101 | 2-5/16 | 59 | 2-1/2 |

10693N (JIC) 37° Female Swivel

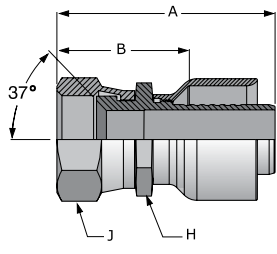

Construction: Steel.
Add "C" for Stainless Steel.

| Part Number | Thread Size | Hose Size | A | | Cutoff Allow. B | | H | J |
|--------------|-------------|-----------|------|-----|-----------------|----|----------|----------|
| | | | inch | mm | inch | mm | Hex inch | Hex inch |
| 10693N-6-6 | 9/16-18 | -6 | 1.70 | 43 | 1-1/8 | 29 | 3/4 | 11/16 |
| 10693N-8-8 | 3/4-16 | -8 | 2.01 | 51 | 1-3/8 | 35 | 7/8 | 3/4 |
| 10693N-10-10 | 7/8-14 | -10 | 2.51 | 64 | 1-9/16 | 40 | 1 | 1 |
| 10693N-12-12 | 1-1/16-12 | -12 | 2.79 | 71 | 1-11/16 | 43 | 1-1/8 | 1-1/4 |
| 10693N-16-16 | 1-5/16-12 | -16 | 3.11 | 79 | 1-7/8 | 48 | 1-3/8 | 1-1/2 |
| 10693N-20-20 | 1-5/8-12 | -20 | 3.32 | 84 | 2 | 51 | 1-3/4 | 2 |
| 10693N-24-24 | 1-7/8-12 | -24 | 3.98 | 101 | 2-1/2 | 64 | 2 | 2-1/4 |
| 10693N-32-32 | 2-1/2-12 | -32 | 4.12 | 105 | 2-9/16 | 65 | 2-1/2 | 2-7/8 |

NOTE: Size -10 incorporates a dual seat.

13793N JIC 37° Swivel 45° Elbow

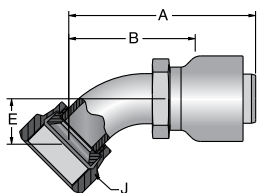

Construction: Steel.
Add "C" for Stainless Steel.

| Part Number | Thread Size | Hose Size | A | | Cutoff Allow. B | | E | | J |
|--------------|-------------|-----------|------|-----|-----------------|-----|------|----|----------|
| | | | inch | mm | inch | mm | inch | mm | Hex inch |
| 13793N-12-12 | 1-1/16-12 | -12 | 3.37 | 86 | 2-1/4 | 57 | .78 | 20 | 1-1/4 |
| 13793N-16-16 | 1-5/16-12 | -16 | 3.71 | 94 | 2-5/8 | 67 | .90 | 23 | 1-1/2 |
| 13793N-20-20 | 1-5/8-12 | -20 | 4.06 | 103 | 2-3/4 | 70 | 1.18 | 43 | 2 |
| 13793N-24-24 | 1-7/8-12 | -24 | 5.76 | 146 | 4-1/4 | 108 | 1.47 | 37 | 2-1/4 |

WARNING

This product can expose you to chemicals including Lead, which is known to the State of California to cause cancer and birth defects or other reproductive harm. For more information go to www.P65Warnings.ca.gov.

Fittings - Permanent Crimp

93N Series

13993N JIC 37° Swivel 90° Elbow Short Drop

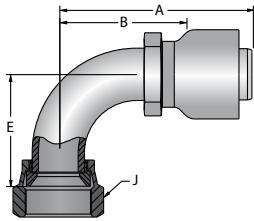

Construction: Steel.
Add "C" for Stainless Steel.

| Part Number | Thread Size | Hose Size | A | | Cutoff Allow. B | | E | | J Hex |
|--------------|-------------|-----------|------|----|-----------------|-----|------|----|-------|
| | | | inch | mm | inch | mm | inch | mm | inch |
| 13993N-8-8 | 3/4-16 | -8 | 2.20 | 56 | 1-9/16 | 40 | 1.09 | 28 | 7/8 |
| 13993N-10-10 | 7/8-14 | -10 | 2.41 | 61 | 1-11/16 | 43 | 1.23 | 31 | 1 |
| 13993N-12-12 | 1-1/16-12 | -12 | 3.28 | 83 | 2-3/16 | 56 | 1.82 | 46 | 1-1/4 |
| 13993N-16-16 | 1-5/16-12 | -16 | 3.71 | 94 | 2-1/2 | 64 | 2.14 | 54 | 1-1/2 |
| 13993N-20-20 | 1-5/8-12 | -20 | 3.89 | 99 | 2-9/16 | 65 | 2.57 | 43 | 2 |
| 13993N-24-24 | 1-7/8-12 | -24 | 5.72 | 58 | 4-1/4 | 108 | 3.17 | 81 | 2-1/4 |

NOTE: Size -10 incorporates a dual seat.

1JC93N Seal-Lok™ Swivel Straight Short

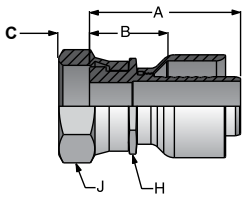

Construction: Steel.
Add "C" for Stainless Steel.

| Part Number | Thread Size | Hose Size | A | | Cutoff Allow. B | | C | | H Hex | J Hex |
|--------------|-------------|-----------|------|----|-----------------|----|------|----|-------|-------|
| | | | inch | mm | inch | mm | inch | mm | inch | inch |
| 1JC93N-12-12 | 1-3/16-12 | -12 | 2.40 | 61 | 1-3/8 | 35 | .57 | 14 | 1-1/4 | 1-3/8 |
| 1JC93N-16-16 | 1-7/16-12 | -16 | 2.61 | 66 | 1-3/8 | 35 | .58 | 15 | 1-1/2 | 1-5/8 |
| 1JC93N-20-20 | 1-11/16-12 | -20 | 2.65 | 67 | 1-5/16 | 33 | .59 | 15 | 1-3/4 | 1-7/8 |

NOTE: When measuring overall length to the end of the nut, B+C dimensions must be used to calculate cut-off allowance

1J793N Seal-Lok™ 45° Elbow

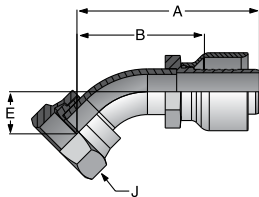

Construction: Steel.
Add "C" for Stainless Steel.

| Part Number | Thread Size | Hose Size | A | | Cutoff Allow. B | | E | | J Hex |
|--------------|-------------|-----------|------|-----|-----------------|----|------|----|-------|
| | | | inch | mm | inch | mm | inch | mm | inch |
| 1J793N-20-20 | 1-11/16-12 | -20 | 4.25 | 108 | 2-15/16 | 75 | 1.00 | 25 | 1-7/8 |

1J993N Seal-Lok™ 90° Elbow Short Drop

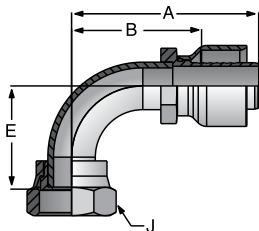

Construction: Steel.
Add "C" for Stainless Steel.

| Part Number | Thread Size | Hose Size | A | | Cutoff Allow. B | | E | | J Hex |
|--------------|-------------|-----------|------|-----|-----------------|----|------|----|-------|
| | | | inch | mm | inch | mm | inch | mm | inch |
| 1J993N-20-20 | 1-11/16-12 | -20 | 4.36 | 111 | 3-1/16 | 78 | 2.51 | 64 | 1-7/8 |

WARNING

This product can expose you to chemicals including Lead, which is known to the State of California to cause cancer and birth defects or other reproductive harm. For more information go to www.P65Warnings.ca.gov.

Fittings - Permanent Crimp

94 Series, 95 Series

A Hose

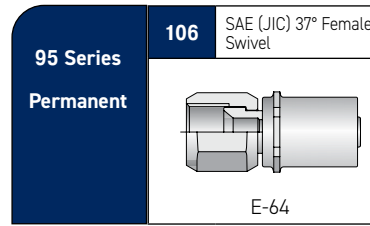
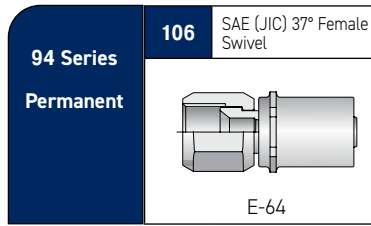

B Tubing Thermoplastic

C Coiled Air Hose & Fittings

10694 SAE (JIC) 37° Female Swivel

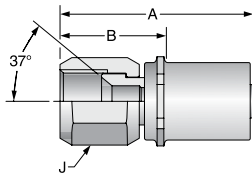

Construction: Steel.
Add "C" for Stainless Steel.

| Part Number | Thread Size | Hose Size | A | | Cutoff Allow. B | | J Hex |
|---------------|-------------|-----------|------|----|-----------------|----|-------|
| | | | inch | mm | inch | mm | |
| 10694-6-6 | 9/16-18 | -6 | 1.78 | 45 | 15/16 | 24 | 11/16 |
| 10694-8-8 | 3/4-16 | -8 | 2.10 | 53 | 1-3/16 | 30 | 7/8 |
| 10694-10-10 | 7/8-14 | -10 | 2.33 | 59 | 1-5/16 | 33 | 1 |
| 10694-12-12 | 1-1/16-12 | -12 | 2.52 | 64 | 1-5/16 | 33 | 1-1/4 |
| 10694-16-16C* | 1-5/16-12 | -16 | 2.72 | 69 | 1-7/16 | 37 | 1-1/2 |

* only available in Stainless Steel construction

D Transportation

10695 SAE (JIC) 37° Female Swivel

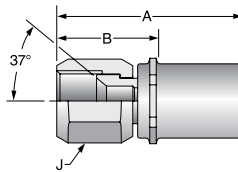

Construction: Steel.
Add "C" for Stainless Steel.

| Part Number | Thread Size | Hose Size | A | | Cutoff Allow. B | | J Hex |
|---------------|-------------|-----------|------|----|-----------------|----|-------|
| | | | inch | mm | inch | mm | |
| 10695-4-4 | 7/16-20 | -4 | 1.48 | 38 | 13/16 | 21 | 9/16 |
| 10695-6-6 | 9/16-18 | -6 | 1.80 | 46 | 15/16 | 24 | 11/16 |
| 10695-8-8 | 3/4-16 | -8 | 2.11 | 54 | 1-3/16 | 30 | 7/8 |
| 10695-12-12 | 1-1/16-12 | -12 | 2.46 | 62 | 1-5/16 | 33 | 1-1/4 |
| 10695-16-16C* | 1-5/16-12 | -16 | 2.73 | 69 | 1-7/16 | 37 | 1-1/2 |

* only available in Stainless Steel construction

E Tooling, Equipment, & Accessories

F General Technical

WARNING

This product can expose you to chemicals including Lead, which is known to the State of California to cause cancer and birth defects or other reproductive harm. For more information go to www.P65Warnings.ca.gov.

Fittings - Permanent Crimp

PAGE Series

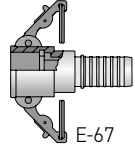
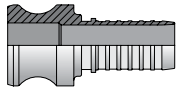
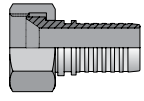
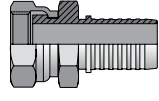
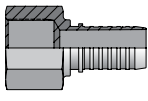
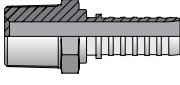
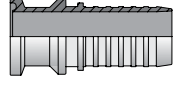
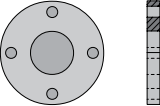
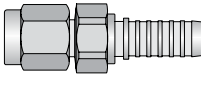
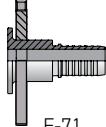
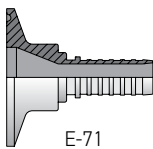
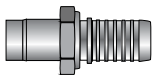
| | | | | | | |
|--|--|---|---|---|---|--|
| PAGE Series Permanent | CL Female Cam & Groove  E-67 | E Male Cam & Groove  E-67 | FJX Female JIC 37° Swivel  E-69 | FORFS Female Seal-Lok™ Swivel Short  E-69 | FP Female NPTF Pipe Rigid  E-67 | |
| | MP Male NPTF Pipe Rigid  E-68 | MSAN Mini Sanitary Flange  E-71 | PF ANSI Flange  E-70 | PLCF Female A-Lok® Compression  E-70 | SFR Flange Retainer  E-71 | |
| | SAN Sanitary Tri-Clamp Flange & Step Downs  E-71 | TUBE A-Lok Male Standpipe Rigid "V" Notch  E-70 | | | | |
| | | | | | | |

PAGE fittings require a PAGE collar. See pg. E-66.

The PAGE fitting call-out does not follow the traditional Parker fitting nomenclature. The end size and hose size are reversed.

WARNING

This product can expose you to chemicals including Lead, which is known to the State of California to cause cancer and birth defects or other reproductive harm. For more information go to www.P65Warnings.ca.gov.

Fittings - Permanent Crimp

PAGE Series

PAGE Fitting Collars - By Size



| Hose Size | Collar # Size | 04 | 06 | 08 | 12 | 14 | 16 | 20 | 24 | 32 | 40 | 48 | 64 |
|--------------|---------------|-------|-------|-------|-------|-------|-------|-------|-------|-------|-------|-------|-------|
| STW STB | ST300 | ST300 | ST300 | ST300 | ST300 | ST300 | ST300 | ST300 | ST300 | | | | |
| SCW SCB | SC300 | ST300 | SC300 | SC300 | SC300 | SC300 | SC300 | SC300 | SC300 | SC300 | | | |
| SCWV SCBV | SC300 | | | SC300 | SC300 | SC300 | SC300 | SC300 | SC300 | SC300 | SC300 | SC300 | SC300 |

Inserts & Collars Sold Separately

Construction: Stainless Steel. Also available in carbon steel "CS".

Examples:

If you need a Female JIC Swivel Fitting for a 08-SCW Hose (1/2" Convolved), place an order for (1) 08-08 FJX-S and (1) 08-SC300.

If you need a Male Pipe Fitting for a 12-STW Hose, place an order for (1) 12-12 MP-S and (1) 12-ST300.

PAGE Fitting Collars - By Style



| Size | ST300 | SC300 |
|--------|-----------------------|-----------------------------------|
| | For use with STW, STB | For use with SCW, SCB, SCWV, SCBV |
| 1/4" | 04-ST300 | 04-SC300 |
| 3/8" | 06-ST300 | 06-SC300 |
| 1/2" | 08-ST300 | 08-SC300 |
| 3/4" | 12-ST300 | 12-SC300 |
| 1" | 16-ST300 | 16-SC300 |
| 1-1/4" | 20Z-ST300 | 20-SC300 |
| 1-1/2" | 24Z-ST300 | 24-SC300 |
| 2" | - | 32-SC300 |
| 2-1/2" | - | 40-SC300 |
| 3" | - | 48-SC300 |
| 4" | - | 64-SC300 |

Construction: Stainless Steel. Also available in carbon steel "CS".

The PAGE fitting call-out does not follow the traditional Parker fitting nomenclature.

The end size and hose size are reversed.

WARNING

This product can expose you to chemicals including Lead, which is known to the State of California to cause cancer and birth defects or other reproductive harm. For more information go to www.P65Warnings.ca.gov.

Fittings - Permanent Crimp

PAGE Series

CL Female Cam & Groove

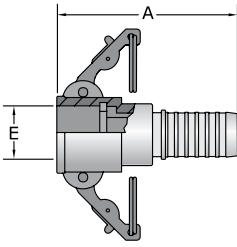

Construction: Stainless Steel.

| Part Number | Hose Size | | A | | E | |
|-------------|-----------|-----|------|-----|------|-----|
| | inch | mm | inch | mm | inch | mm |
| 16-16CL-S | 1 | 25 | 4.2 | 107 | 1.44 | 37 |
| 24-24CL-S | 1-1/2 | 38 | 5.2 | 132 | 2.10 | 53 |
| 32-32CL-S | 2 | 51 | 6.0 | 152 | 2.48 | 63 |
| 48-48CL-S | 3 | 76 | 7.2 | 183 | 3.60 | 91 |
| 64-64CL-S | 4 | 102 | 7.8 | 198 | 4.70 | 119 |

NOTE: Also available as encapsulated female cam under part number TEC and TECL.

The PAGE fitting call-out does not follow the traditional Parker fitting nomenclature.

The end size and hose size are reversed.

E Male Cam & Groove

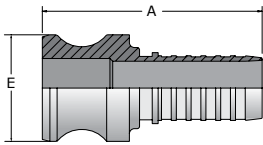

Construction: Stainless Steel.

| Part Number | Hose Size | | A | | E | |
|-------------|-----------|-----|------|-----|------|-----|
| | inch | mm | inch | mm | inch | mm |
| 12-12E-S | 3/4 | 19 | 2.60 | 66 | 1.26 | 32 |
| 16-16E-S | 1 | 25 | 2.91 | 74 | 1.44 | 37 |
| 20-20E-S | 1-1/4 | 32 | 3.64 | 93 | 1.78 | 45 |
| 24-24E-S | 1-1/2 | 38 | 4.03 | 102 | 2.10 | 53 |
| 32-32E-S | 2 | 51 | 4.75 | 121 | 2.48 | 63 |
| 48-48E-S | 3 | 76 | 5.75 | 146 | 3.60 | 91 |
| 64-64E-S | 4 | 102 | 5.88 | 149 | 4.70 | 119 |

NOTE: Also available as encapsulated female cam under part number TEC and TECL.

FP Female NPTF Pipe Rigid

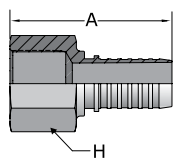

Construction: Stainless Steel.

| Part Number | Thread Size | Hose Size | | A | | H |
|-------------|--------------|-----------|----|------|-----|--------|
| | | inch | mm | inch | mm | Hex |
| 04-04FP-S | 1/4-18 | 1/4 | 6 | 1.63 | 41 | 3/4 |
| 06-06FP-S | 3/8-18 | 3/8 | 10 | 1.73 | 44 | 7/8 |
| 08-08FP-S | 1/2-14 | 1/2 | 13 | 2.25 | 57 | 1-1/16 |
| 12-12FP-S | 3/4-14 | 3/4 | 19 | 2.60 | 66 | 1-5/16 |
| 16-16FP-S | 1-11 1/2 | 1 | 25 | 2.85 | 72 | 1-5/8 |
| 20-20FP-S | 1 1/4-11 1/2 | 1-1/4 | 32 | 3.50 | 89 | 2 |
| 24-24FP-S | 1 1/2-11 1/2 | 1-1/2 | 38 | 3.63 | 92 | 2-3/8 |
| 32-32FP-S | 2-11 1/2 | 2 | 51 | 4.25 | 108 | 2-7/8 |

WARNING

This product can expose you to chemicals including Lead, which is known to the State of California to cause cancer and birth defects or other reproductive harm. For more information go to www.P65Warnings.ca.gov.

Fittings - Permanent Crimp

PAGE Series

MP Male NPTF Pipe Rigid

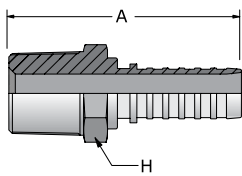

Construction: Stainless Steel.

| Part Number | Thread Size | Hose Size | | A | | H Hex inch |
|-------------|--------------|-----------|-----|------|-----|------------|
| | | inch | mm | inch | mm | |
| 04-04MP-S | 1/4-18 | 1/4 | 6 | 1.63 | 41 | 9/16 |
| 06-06MP-S | 3/8-18 | 3/8 | 10 | 1.76 | 45 | 11/16 |
| 08-08MP-S | 1/2-14 | 1/2 | 13 | 2.34 | 59 | 7/8 |
| 12-12MP-S | 3/4-14 | 3/4 | 19 | 2.59 | 66 | 1-1/8 |
| 16-16MP-S | 1-11 1/2 | 1 | 25 | 3.00 | 76 | 1-3/8 |
| 20-20MP-S | 1 1/4-11 1/2 | 1-1/4 | 32 | 3.39 | 86 | 1-3/4 |
| 24-24MP-S | 1 1/2-11 1/2 | 1-1/2 | 38 | 3.89 | 99 | 2 |
| 32-32MP-S | 2-11 1/2 | 2 | 51 | 4.58 | 116 | 2-1/2 |
| 40-40MP-S | 2-1/2 8 | 2-1/2 | 64 | 5.28 | 134 | 3 |
| 48-48MP-S | 3-8 | 3 | 76 | 5.93 | 151 | 3-3/4 |
| 64-64MP-S | 4-8 | 4 | 102 | 6.82 | 173 | 4-5/8 |

The PAGE fitting call-out does not follow the traditional Parker fitting nomenclature.

The end size and hose size are reversed.

FJX Female JIC 37° Swivel

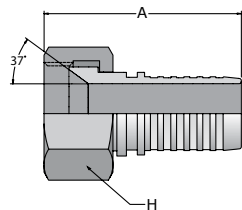

Construction: Stainless Steel.

| Part Number | Thread Size | Hose Size | | A | | H Hex inch |
|-------------|-------------|-----------|----|------|-----|------------|
| | | inch | mm | inch | mm | |
| 04-04FJX-S | 7/16-20 | 1/4 | 6 | 1.44 | 37 | 9/16 |
| 06-06FJX-S | 9/16-18 | 3/8 | 10 | 1.65 | 42 | 11/16 |
| 08-08FJX-S | 3/4-16 | 1/2 | 13 | 2.13 | 54 | 7/8 |
| 12-12FJX-S | 1-1/16-12 | 3/4 | 19 | 2.54 | 65 | 1-1/4 |
| 16-16FJX-S | 1-5/16-12 | 1 | 25 | 2.76 | 70 | 1-1/2 |
| 20-20FJX-S | 1-5/8-12 | 1-1/4 | 32 | 3.25 | 83 | 2 |
| 24-24FJX-S | 1-7/8-12 | 1-1/2 | 38 | 3.73 | 95 | 2-1/4 |
| 32-32FJX-S | 2-1/2-12 | 2 | 51 | 4.55 | 116 | 2-7/8 |
| 40-40FJX-S | 3-12 | 2-1/2 | 64 | 4.76 | 121 | 3-3/8 |

WARNING

This product can expose you to chemicals including Lead, which is known to the State of California to cause cancer and birth defects or other reproductive harm. For more information go to www.P65Warnings.ca.gov.

Fittings - Permanent Crimp

PAGE Series

FORFS Female Seal-Lok® Swivel Short

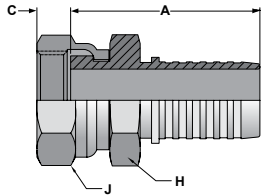

Construction: Stainless Steel.

| Part Number | Thread Size | Hose Size | | A | | C | | H Hex | J Hex |
|--------------|-------------|-----------|----|------|-----|------|----|-------|-------|
| | | inch | mm | inch | mm | inch | mm | inch | inch |
| 04-04FORFS-S | 9/16-18 | 1/4 | 6 | 1.50 | 38 | .32 | 8 | 9/16 | 11/16 |
| 06-06FORFS-S | 11/16-16 | 3/8 | 10 | 1.85 | 47 | .32 | 8 | 11/16 | 13/16 |
| 08-08FORFS-S | 13/16-16 | 1/2 | 13 | 2.00 | 51 | .43 | 11 | 13/16 | 15/16 |
| 12-12FORFS-S | 1-3/16-12 | 3/4 | 19 | 2.30 | 58 | .57 | 14 | 1-1/8 | 1-3/8 |
| 16-16FORFS-S | 1-7/16-12 | 1 | 25 | 2.50 | 64 | .58 | 15 | 1-3/8 | 1-5/8 |
| 24-24FORFS-S | 2-12 | 1-1/2 | 38 | 3.98 | 101 | .59 | 15 | 2 | 2-1/4 |

PLCF Female A-LOK® Compression (With Nut & Ferrules)

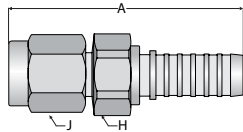

Construction: Stainless Steel.

| Part Number | Thread Size | Hose Size | | A | | J Hex | H Hex |
|-------------|-------------|-----------|----|------|----|-------|-------|
| | | inch | mm | inch | mm | inch | inch |
| 04-04PLCF-S | 7/16-20 | 1/4 | 6 | 1.52 | 39 | 9/16 | 9/16 |
| 06-06PLCF-S | 9/16-20 | 3/8 | 10 | 1.63 | 41 | 11/16 | 11/16 |
| 08-08PLCF-S | 3/4-20 | 1/2 | 13 | 2.05 | 52 | 7/8 | 7/8 |
| 12-12PLCF-S | 1-20 | 3/4 | 19 | 2.30 | 58 | 1-1/8 | 1-1/8 |
| 16-16PLCF-S | 1-5/16-20 | 1 | 25 | 2.57 | 65 | 1-3/8 | 1-1/2 |

The PAGE fitting call-out does not follow the traditional Parker fitting nomenclature.

The end size and hose size are reversed.

TUBE A-LOK® Male Standpipe Rigid with "V" Notch

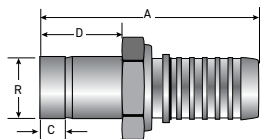

Construction: Stainless Steel.

| Part Number | Diameter R | Hose Size | | A | | C | | D | | H Hex |
|-------------|------------|-----------|----|------|----|------|----|------|----|-------|
| | | inch | mm | inch | mm | inch | mm | inch | mm | inch |
| 04-04TUBE-S | 1/4 | 1/4 | 6 | 1.75 | 45 | .18 | 5 | .66 | 17 | 7/16 |
| 06-06TUBE-S | 3/8 | 3/8 | 10 | 2.06 | 52 | .25 | 6 | .85 | 2 | 5/8 |
| 08-08TUBE-S | 1/2 | 1/2 | 13 | 2.56 | 65 | .34 | 9 | .97 | 25 | 3/4 |
| 12-12TUBE-S | 3/4 | 3/4 | 19 | 2.86 | 73 | .40 | 10 | 1.02 | 26 | 1-1/8 |
| 16-16TUBE-S | 1 | 1 | 25 | 3.34 | 85 | .52 | 13 | 1.30 | 33 | 1-3/8 |
| 20-20TUBE-S | 1-1/4 | 1-1/4 | 32 | 4.05 | 10 | .50 | 13 | 1.75 | 45 | 1-3/4 |

WARNING

This product can expose you to chemicals including Lead, which is known to the State of California to cause cancer and birth defects or other reproductive harm. For more information go to www.P65Warnings.ca.gov.

Fittings - Permanent Crimp

PAGE Series

PF ANSI B16.5 Flange

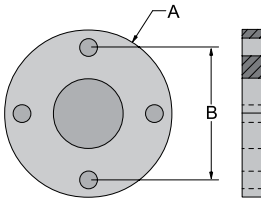

Construction: 316 Stainless Steel.

| Part Number Flange | Flange Diameter A | | Hose Size | | Bolt Spacing B | |
|-----------------------|-------------------|-----|-----------|-----|----------------|-----|
| | inch | mm | inch | mm | inch | mm |
| 08-PF156 | 3-1/2 | 89 | 1/2 | 13 | 2-3/8 | 60 |
| 12-PF156 | 3-7/8 | 98 | 3/4 | 19 | 2-3/4 | 70 |
| 16-PF156 | 4-1/4 | 108 | 1 | 25 | 3-1/8 | 79 |
| 20-PF156 | 4-5/8 | 117 | 1-1/4 | 32 | 3-1/2 | 89 |
| 24-PF156 | 5 | 127 | 1-1/2 | 38 | 3-7/8 | 98 |
| 32-PF156 | 6 | 152 | 2 | 51 | 4-3/4 | 120 |
| 40-PF156 | 7 | 178 | 2-1/2 | 64 | 5-1/2 | 140 |
| 48-PF156 | 7-1/2 | 191 | 3 | 76 | 6 | 152 |
| 64-PF156 | 9 | 229 | 4 | 102 | 7-1/2 | 191 |

The PAGE fitting call-out does not follow the traditional Parker fitting nomenclature.

The end size and hose size are reversed.

SFR Flange Retainer

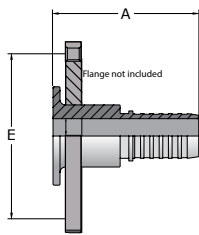

Construction: Stainless Steel.

| Part Number | Flange Diameter | | Hose Size | | A | | Bolt Spacing E | |
|-------------|-----------------|-----|-----------|-----|------|-----|----------------|-----|
| | inch | mm | inch | mm | inch | mm | inch | mm |
| 08-08SFR-S | 3-1/2 | 89 | 1/2 | 13 | 2.30 | 58 | 2-3/8 | 60 |
| 12-12SFR-S | 3-7/8 | 98 | 3/4 | 19 | 2.60 | 66 | 2-3/4 | 70 |
| 16-16SFR-S | 4-1/4 | 108 | 1 | 25 | 3.00 | 76 | 3-1/8 | 79 |
| 20-20SFR-S | 4-5/8 | 117 | 1-1/4 | 32 | 3.25 | 83 | 3-1/2 | 89 |
| 24-24SFR-S | 5 | 127 | 1-1/2 | 38 | 3.65 | 93 | 3-7/8 | 98 |
| 32-32SFR-S | 6 | 152 | 2 | 51 | 4.25 | 108 | 4-3/4 | 120 |
| 40-40SFR-S | 7 | 178 | 2-1/2 | 64 | 5.00 | 127 | 5-1/2 | 140 |
| 48-48SFR-S | 7-1/2 | 191 | 3 | 76 | 5.50 | 140 | 6 | 152 |
| 64-64SFR-S | 9 | 229 | 4 | 102 | 7.00 | 178 | 7-1/2 | 191 |

WARNING

This product can expose you to chemicals including Lead, which is known to the State of California to cause cancer and birth defects or other reproductive harm. For more information go to www.P65Warnings.ca.gov.

Fittings - Permanent Crimp

PAGE Series

MSAN Mini Sanitary Flange

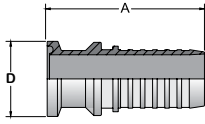

Construction: Stainless Steel.

| Part Number | Hose Size | | A | | Flange Size D | |
|-------------|-----------|----|------|----|---------------|----|
| | inch | mm | inch | mm | inch | mm |
| 04-04MSAN-S | 1/4 | 6 | 1.41 | 36 | .98 | 25 |
| 04-08MSAN-S | 1/4 | 6 | 1.50 | 38 | .98 | 25 |
| 06-06MSAN-S | 3/8 | 10 | 1.53 | 39 | .98 | 25 |
| 06-08MSAN-S | 3/8 | 10 | 1.53 | 39 | .98 | 25 |
| 06-12MSAN-S | 3/8 | 10 | 1.66 | 42 | .98 | 25 |
| 08-08MSAN-S | 1/2 | 13 | 1.90 | 48 | .98 | 25 |
| 08-12MSAN-S | 1/2 | 13 | 1.94 | 49 | .98 | 25 |
| 12-12MSAN-S | 3/4 | 19 | 2.16 | 55 | .98 | 25 |
| 16-16MSAN-S | 1 | 25 | 2.27 | 58 | 1.34 | 34 |

The PAGE fitting call-out does not follow the traditional Parker fitting nomenclature.

The end size and hose size are reversed.

SAN Sanitary Tri-Clamp Flange & Step-Downs

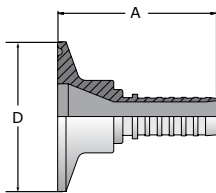

Construction: Stainless Steel.

| Part Number | Hose Size | | A | | Flange Size D | |
|-------------|-----------|-----|------|-----|---------------|-----|
| | inch | mm | inch | mm | inch | mm |
| 08-08SAN-S | 1/2 | 13 | 2.11 | 54 | 1.98 | 50 |
| 08-16SAN-S | 1/2 | 13 | 2.11 | 54 | 1.98 | 50 |
| 08-24SAN-S | 1/2 | 13 | 2.34 | 59 | 1.98 | 50 |
| 12-12SAN-S | 3/4 | 19 | 2.32 | 59 | 1.98 | 50 |
| 16-16SAN-S | 1 | 25 | 2.45 | 62 | 1.98 | 50 |
| 12-24SAN-S | 3/4 | 19 | 2.34 | 59 | 1.98 | 50 |
| 16-24SAN-S | 1 | 25 | 2.32 | 59 | 1.98 | 50 |
| 24-24SAN-S | 1-1/2 | 38 | 3.1 | 79 | 1.98 | 50 |
| 24-32SAN-S | 1-1/2 | 38 | 3.12 | 79 | 2.52 | 64 |
| 32-32SAN-S | 2 | 51 | 3.67 | 93 | 2.52 | 64 |
| 40-40SAN-S | 2-1/2 | 64 | 4 | 102 | 3.05 | 77 |
| 48-48SAN-S | 3 | 76 | 4.5 | 114 | 3.58 | 91 |
| 64-64SAN-S | 4 | 102 | 4.75 | 121 | 4.68 | 119 |

WARNING

This product can expose you to chemicals including Lead, which is known to the State of California to cause cancer and birth defects or other reproductive harm. For more information go to www.P65Warnings.ca.gov.

Fittings - Permanent Crimp CG Series

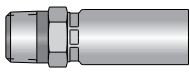
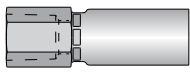
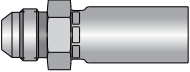
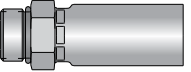
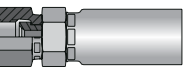
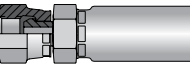
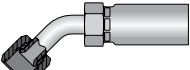
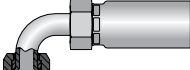
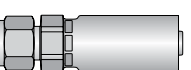
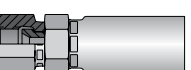
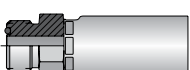
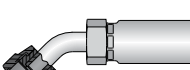
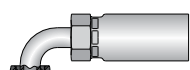
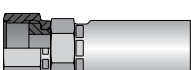
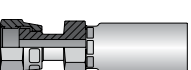
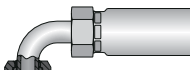
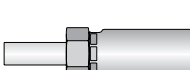
| | | | | | | |
|-------------------------------------|--|--|--|---|---|---|
| A Hose | CG Series Permanent | 101 Male Taper Pipe Rigid | 102 Female Taper Pipe Rigid | 103 Male (JIC) 37° Rigid | 105 Male Str. Thread O-ring | 106 SAE (JIC) 37° Swivel |
| | |  E-72 |  E-73 |  E-73 |  E-73 |  E-73 |
| B Tubing Thermoplastic | 107 Female Pipe Swivel | 137 Female JIC 37° Swivel 45° Elbow | 139 FM JIC 37° Swivel 90° Elbow Short | 1AL A-Lok® Compression | 1FU (JIS)/BSP 30° Flare Female Swivel | |
| |  E-74 |  E-74 |  E-74 |  E-74 |  E-75 | |
| C Coiled Air Hose & Fittings | 1J0 Male Seal-Lok™ Rigid Str. w/O-ring | 1J7 Female Seal-Lok™ 45° Elbow | 1J9 Female Seal-Lok™ 90° Elbow Short | 1JC Female Seal-Lok™ Str. Swivel Short | 1JS Female Seal-Lok™ Straight | |
| |  E-75 |  E-75 |  E-75 |  E-76 |  E-76 | |
| D Transportation | 1L9 FM JIC 37° Swivel 90° Elbow, SPL Drop | 1TU Universal Tube Stub End | | | | |
| |  E-76 |  E-76 | | | | |

101CG Male Taper Pipe Rigid

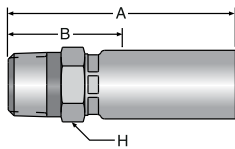

Construction: Steel. Add "C" for Stainless Steel.

| Part Number | Thread Size | Hose I.D. | | A | | Cutoff Allow. B | | H Hex inch |
|-------------|-------------|-----------|----|------|-----|-----------------|----|------------|
| | | inch | mm | inch | mm | inch | mm | |
| 101CG-2-3 | 1/8-27 | 3/16 | 5 | 1.94 | 49 | 1 | 25 | 9/16 |
| 101CG-2-4 | 1/8-27 | 1/4 | 6 | 2.13 | 54 | 1 | 25 | 5/8 |
| 101CG-4-3 | 1/4-18 | 3/16 | 5 | 2.12 | 54 | 1-3/16 | 30 | 11/16 |
| 101CG-4-4 | 1/4-18 | 1/4 | 6 | 2.31 | 59 | 1-3/16 | 30 | 11/16 |
| 101CG-4-6 | 1/4-18 | 3/8 | 10 | 2.66 | 68 | 1-5/16 | 33 | 3/4 |
| 101CG-6-4 | 3/8-18 | 1/4 | 6 | 2.41 | 61 | 1-5/16 | 33 | 3/4 |
| 101CG-6-6 | 3/8-18 | 3/8 | 10 | 2.66 | 68 | 1-5/16 | 33 | 3/4 |
| 101CG-6-8 | 3/8-18 | 1/2 | 13 | 2.85 | 72 | 1-5/16 | 33 | 7/8 |
| 101CG-8-6 | 1/2-14 | 3/8 | 10 | 2.91 | 74 | 1-9/16 | 40 | 15/16 |
| 101CG-8-8 | 1/2-14 | 1/2 | 13 | 3.09 | 78 | 1-9/16 | 40 | 15/16 |
| 101CG-12-12 | 3/4-14 | 3/4 | 19 | 3.91 | 99 | 1-11/16 | 43 | 1-1/4 |
| 101CG-16-16 | 1-11-1/2 | 1 | 25 | 4.76 | 121 | 2 | 51 | 1-3/4 |

WARNING

This product can expose you to chemicals including Lead, which is known to the State of California to cause cancer and birth defects or other reproductive harm. For more information go to www.P65Warnings.ca.gov.

Fittings - Permanent Crimp CG Series

102CG Female Taper Pipe Rigid

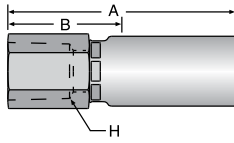

Construction: Steel. Add "C" for Stainless Steel.

| Part Number | Thread Size | Hose I.D. | | A | | Cutoff Allow. B | | H Hex |
|-------------|-------------|-----------|----|------|----|-----------------|----|--------|
| | | inch | mm | inch | mm | inch | mm | inch |
| 102CG-4-4 | 1/4-18 | 1/4 | 6 | 2.39 | 61 | 1-1/4 | 32 | 3/4 |
| 102CG-6-4 | 3/8-18 | 1/4 | 6 | 2.60 | 66 | 1-1/2 | 38 | 7/8 |
| 102CG-8-8 | 1/2-14 | 1/2 | 13 | 2.87 | 73 | 1-3/8 | 35 | 1-1/16 |

103CG Male (JIC) 37° Rigid

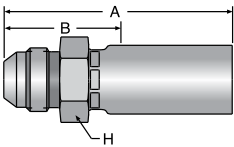

Construction: Steel. Add "C" for Stainless Steel.

| Part Number | Diameter R | Hose Size | | A | | C | | H Hex |
|-------------|------------|-----------|----|------|----|--------|----|-------|
| | | inch | mm | inch | mm | inch | mm | inch |
| 103CG-4-4 | 7/16-20 | 1/4 | 6 | 2.31 | 58 | 1-3/16 | 30 | 5/8 |
| 103CG-5-4 | 1/2-20 | 1/4 | 6 | 2.30 | 58 | 1-3/16 | 30 | 5/8 |
| 103CG-6-4 | 9/16-18 | 1/4 | 6 | 2.30 | 58 | 1-3/16 | 30 | 11/16 |
| 103CG-6-6 | 9/16-18 | 3/8 | 10 | 2.65 | 67 | 1-1/4 | 32 | 3/4 |

105CG Male Straight Thread O-ring (Nitrile O-ring included)

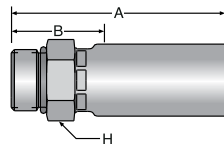

Construction: Steel. Add "C" for Stainless Steel.

| Part Number | Diameter R | Hose Size | | A | | C | | H Hex |
|-------------|------------|-----------|----|------|----|--------|----|-------|
| | | inch | mm | inch | mm | inch | mm | inch |
| 105CG-4-3 | 7/16-20 | 3/16 | 4 | 1.98 | 50 | 1-1/8 | 29 | 9/16 |
| 105CG-4-4 | 7/16-20 | 1/4 | 6 | 2.11 | 54 | 1 | 25 | 5/8 |
| 105CG-6-4 | 9/16-18 | 1/4 | 6 | 2.14 | 54 | 1 | 25 | 11/16 |
| 105CG-6-6 | 9/16-18 | 3/8 | 10 | 2.42 | 61 | 1-1/8 | 29 | 3/4 |
| 105CG-8-8 | 3/4-16 | 1/2 | 13 | 2.65 | 67 | 1-3/16 | 30 | 7/8 |
| 105CG-10-8 | 7/8-14 | 1/2 | 13 | 2.77 | 70 | 1-5/16 | 33 | 1 |

NOTE: Nitrile O-ring.

106CG SAE (JIC) 37° Swivel

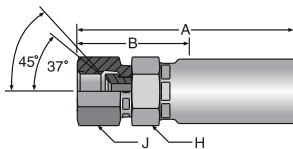

Construction: Steel. Add "C" for Stainless Steel.

| Part Number | Thread Size | Hose I.D. | | A | | Cutoff Allow. B | | H Hex | J Hex |
|-------------|-------------|-----------|----|------|-----|-----------------|----|-------|--------|
| | | inch | mm | inch | mm | inch | mm | inch | inch |
| 106CG-3-3 | 3/8-24 | 3/16 | 5 | 2.23 | 57 | 1-5/16 | 33 | 9/16 | 9/16 |
| 106CG-4-3 | 7/16-20 | 3/16 | 5 | 2.23 | 57 | 1-1/4 | 32 | 9/16 | 9/16 |
| 106CG-4-4 | 7/16-20 | 1/4 | 6 | 2.36 | 60 | 1-3/16 | 30 | 5/8 | 9/16 |
| 106CG-5-4 | 1/2-20 | 1/4 | 6 | 2.43 | 62 | 1-1/4 | 32 | 5/8 | 5/8 |
| 106CG-6-4 | 9/16-18 | 1/4 | 6 | 2.45 | 62 | 1-5/16 | 33 | 5/8 | 11/16 |
| 106CG-6-6 | 9/16-18 | 3/8 | 10 | 2.70 | 69 | 1-5/16 | 33 | 11/16 | 11/16 |
| 106CG-8-6 | 3/4-16 | 3/8 | 10 | 2.89 | 73 | 1-1/2 | 38 | 11/16 | 7/8 |
| 106CG-8-8 | 3/4-16 | 1/2 | 13 | 3.08 | 78 | 1-1/2 | 38 | 7/8 | 7/8 |
| 106CG-10-8 | 7/8-14 | 1/2 | 13 | 3.12 | 79 | 1-5/8 | 41 | 7/8 | 1-1/16 |
| 106CG-12-8 | 1-1/16-12 | 1/2 | 13 | 3.35 | 85 | 1-13/16 | 46 | 1 | 1-1/4 |
| 106CG-12-12 | 1-1/16-12 | 3/4 | 19 | 4.17 | 106 | 1-13/16 | 46 | 1-1/4 | 1-5/16 |
| 106CG-16-12 | 1-5/16-12 | 3/4 | 19 | 4.27 | 108 | 2 | 51 | 1-1/2 | 1-5/8 |
| 106CG-16-16 | 1-5/16-12 | 1 | 25 | 4.93 | 125 | 2-3/16 | 56 | 1-3/4 | 1-5/8 |

NOTE: Sizes -4, -5, -8 and -10 incorporate a dual seat.

WARNING

This product can expose you to chemicals including Lead, which is known to the State of California to cause cancer and birth defects or other reproductive harm. For more information go to www.P65Warnings.ca.gov.

Fittings - Permanent Crimp

CG Series

A Hose

107CG Female Pipe Swivel

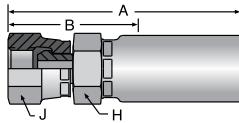

| Part Number | Thread Size | Hose I.D. | | A | | Cutoff Allow. B | | H Hex | J Hex |
|-------------|-------------|-----------|----|------|----|-----------------|----|-------|-------|
| | | inch | mm | inch | mm | inch | mm | inch | inch |
| 107CG-6-6 | 3/8-18 | 3/8 | 10 | 2.61 | 66 | 1-3/16 | 30 | 11/16 | 7/8 |

Construction: Steel. Add "C" for Stainless Steel.

137CG Female JIC 37° Swivel 45° Elbow

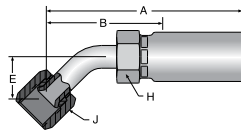

| Part Number | Thread Size | Hose I.D. | | A | | Cutoff Allow. B | | E | | H Hex | J Hex |
|-------------|-------------|-----------|----|------|----|-----------------|----|------|----|-------|-------|
| | | inch | mm | inch | mm | inch | mm | inch | mm | inch | inch |
| 137CG-4-4 | 7/16-20 | 1/4 | 6 | 2.49 | 63 | 1-1/2 | 38 | 0.33 | 8 | 5/8 | 9/16 |
| 137CG-6-6 | 9/16-18 | 3/8 | 10 | 2.91 | 74 | 1-9/16 | 40 | 0.39 | 10 | 3/4 | 11/16 |
| 137CG-8-8 | 3/4-16 | 1/2 | 13 | 3.37 | 86 | 1-13/16 | 46 | 0.55 | 14 | 7/8 | 7/8 |

Construction: Steel. Add "C" for Stainless Steel.

139CG Female JIC 37° Swivel 90° Elbow

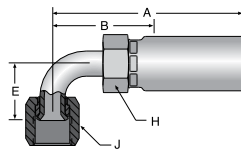

| Part Number | Thread Size | Hose I.D. | | A | | Cutoff Allow. B | | E | | H Hex | J Hex |
|-------------|-------------|-----------|----|------|-----|-----------------|----|------|----|-------|-------|
| | | inch | mm | inch | mm | inch | mm | inch | mm | inch | inch |
| 139CG-4-4 | 7/16-20 | 1/4 | 6 | 2.49 | 63 | 1-3/8 | 35 | 0.68 | 17 | 5/8 | 9/16 |
| 139CG-6-4 | 9/16-18 | 1/4 | 6 | 2.57 | 65 | 1-9/16 | 36 | 0.85 | 22 | 5/8 | 11/16 |
| 139CG-6-6 | 9/16-18 | 3/8 | 10 | 2.88 | 73 | 1-1/2 | 38 | 0.91 | 23 | 3/4 | 11/16 |
| 139CG-8-6 | 3/4-16 | 3/8 | 10 | 2.92 | 74 | 1-9/16 | 40 | 1.09 | 28 | 3/4 | 7/8 |
| 139CG-8-8 | 3/4-16 | 1/2 | 13 | 3.11 | 79 | 1-5/8 | 41 | 1.09 | 28 | 7/8 | 7/8 |
| 139CG-12-12 | 1-1/16-12 | 3/4 | 19 | 4.55 | 116 | 2-1/4 | 57 | 1.82 | 46 | 1-1/4 | 1-1/4 |

Construction: Steel. Add "C" for Stainless Steel.

1ALCG A-LOK® Compression

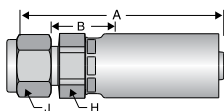

| Part Number | Hose Size | A | | Cutoff Allow. B | | H Hex | J Hex |
|-------------|-----------|------|----|-----------------|----|-------|-------|
| | | inch | mm | inch | mm | inch | inch |
| 1ALCG-6-6C | -6 | 1.46 | 37 | 7/16 | 11 | 3/4 | 11/16 |

Construction: Stainless steel.

NOTE: Nuts and Ferrules are Manufactured by the Instrumentation Products Division. Refer to Catalog 4230/4233 for information.

Nut part No. is XNUX-316
Back ferrule part No. is XBFX-316

Front ferrule part No. is XFFX-316
X denotes dash size.

WARNING

This product can expose you to chemicals including Lead, which is known to the State of California to cause cancer and birth defects or other reproductive harm. For more information go to www.P65Warnings.ca.gov.

B Tubing Thermoplastic

C Coiled Air Hose & Fittings

D Transportation

E Fittings

F Tooling, Equipment, & Accessories

G General Technical

Fittings - Permanent Crimp CG Series

1FUCG (JIS)/BSP 30° Flare Female Swivel ISO 228-1

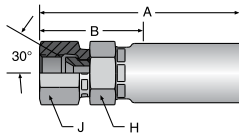

Construction: Steel. Add "C" for Stainless Steel.

| Part Number | Thread Size | Hose I.D. | | A | | Cutoff Allow. B | | H Hex | J Hex |
|-------------|-------------|-----------|----|------|----|-----------------|----|-------|-------|
| | | inch | mm | inch | mm | inch | mm | mm | mm |
| 1FUCG-4-4 | PF 1/4-19 | 1/4 | 6 | 2.48 | 63 | 1-9/16 | 40 | 19 | 19 |

1J0CG Male Seal-Lok™ Rigid Straight (with Nitrile O-ring) ISO 12151-1-S

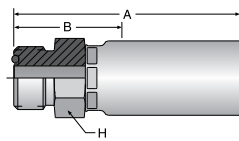

Construction: Steel. Add "C" for Stainless Steel.

| Part Number | Thread Size | Hose I.D. | | A | | Cutoff Allow. B | | H Hex |
|-------------|-------------|-----------|----|------|----|-----------------|----|-------|
| | | inch | mm | inch | mm | inch | mm | inch |
| 1J0CG-4-4 | 9/16-18 | 1/4 | 6 | 2.20 | 56 | 1-1/16 | 27 | 5/8 |

NOTE: Nitrile O-ring.

1J7CG Female Seal-Lok™ Swivel 45° Elbow ISO 12151-1-SWE45

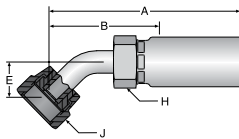

Construction: Steel. Add "C" for Stainless Steel.

| Part Number | Thread Size | Hose I.D. | | A | | Cutoff Allow. B | | E | | H Hex | J Hex |
|-------------|-------------|-----------|----|------|-----|-----------------|----|------|----|-------|-------|
| | | inch | mm | inch | mm | inch | mm | inch | mm | inch | inch |
| 1J7CG-4-4 | 9/16-18 | 1/4 | 6 | 2.66 | 68 | 1-1/2 | 38 | 0.41 | 10 | 5/8 | 11/16 |
| 1J7CG-8-8 | 13/16-16 | 1/2 | 13 | 3.43 | 87 | 1-15/16 | 49 | 0.59 | 15 | 7/8 | 15/16 |
| 1J7CG-12-12 | 1-3/16-12 | 3/4 | 19 | 4.51 | 115 | 2-3/16 | 56 | 0.81 | 21 | 1-1/4 | 1-3/8 |

1J9CG Female Seal-Lok™ Swivel 90° Elbow ISO 12151-1-SWE90

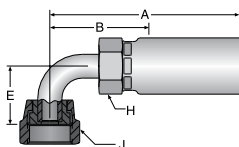

Construction: Steel. Add "C" for Stainless Steel.

| Part Number | Thread Size | Hose I.D. | | A | | Cutoff Allow. B | | E | | H Hex | J Hex |
|-------------|-------------|-----------|----|------|-----|-----------------|----|------|----|-------|-------|
| | | inch | mm | inch | mm | inch | mm | inch | mm | inch | inch |
| 1J9CG-4-4 | 9/16-18 | 1/4 | 6 | 2.49 | 63 | 1-3/8 | 35 | 0.82 | 21 | 5/8 | 11/16 |
| 1J9CG-6-6 | 11/16-16 | 3/8 | 10 | 2.85 | 72 | 1-1/2 | 38 | 0.91 | 23 | 3/4 | 13/16 |
| 1J9CG-12-12 | 1-3/16-12 | 3/4 | 19 | 4.42 | 112 | 2-1/8 | 54 | 1.89 | 48 | 1-1/4 | 1-3/8 |
| 1J9CG-16-16 | 1-7/16-12 | 1 | 25 | 5.78 | 147 | 3 | 76 | 2.28 | 58 | 1-3/4 | 1-5/8 |

WARNING

This product can expose you to chemicals including Lead, which is known to the State of California to cause cancer and birth defects or other reproductive harm. For more information go to www.P65Warnings.ca.gov.

Fittings - Permanent Crimp CG Series

1JCCG Female Seal-Lok™ Straight Swivel Short ISO 12151-1-SWSA

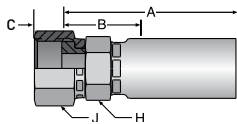

Construction: Steel. Add "C" for Stainless Steel.

| Part Number | Thread Size | Hose I.D. | | A | | Cutoff Allow. B | | C | | H Hex | J Hex |
|-------------|-------------|-----------|----|------|-----|-----------------|----|------|----|-------|-------|
| | | inch | mm | inch | mm | inch | mm | inch | mm | inch | inch |
| 1JCCG-4-3 | 9/16-18 | 3/16 | 5 | 1.88 | 48 | 15/16 | 24 | .34 | 9 | 9/16 | 11/16 |
| 1JCCG-4-4 | 9/16-18 | 1/4 | 6 | 2.16 | 55 | 1-1/16 | 25 | .34 | 9 | 5/8 | 11/16 |
| 1JCCG-6-4 | 11/16-16 | 1/4 | 6 | 2.22 | 56 | 1-1/16 | 27 | .32 | 8 | 11/16 | 13/16 |
| 1JCCG-6-6 | 11/16-16 | 3/8 | 10 | 2.47 | 63 | 1-1/16 | 27 | .32 | 8 | 11/16 | 13/16 |
| 1JCCG-8-6 | 13/16-16 | 3/8 | 10 | 2.56 | 65 | 1-3/16 | 30 | .43 | 11 | 7/8 | 15/16 |
| 1JCCG-8-8 | 13/16-16 | 1/2 | 13 | 2.75 | 70 | 1-3/16 | 30 | .43 | 11 | 7/8 | 15/16 |
| 1JCCG-10-8 | 1-14 | 1/2 | 13 | 2.95 | 75 | 1-3/8 | 35 | .48 | 12 | 1-1/8 | 1-1/8 |
| 1JCCG-12-12 | 1-3/16-12 | 3/4 | 19 | 3.86 | 98 | 1-1/2 | 38 | .55 | 14 | 1-1/4 | 1-3/8 |
| 1JCCG-16-16 | 1-7/16-12 | 1 | 25 | 4.66 | 118 | 1-7/8 | 48 | .56 | 14 | 1-3/4 | 1-5/8 |

NOTE: When measuring overall length to the end of the nut, B+C dimensions must be used to calculate cut-off allowance

1JSCG Female Seal-Lok™ Straight

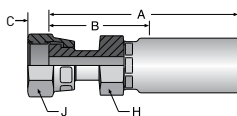

Construction: Steel. Add "C" for Stainless Steel.

| Part Number | Thread Size | Hose I.D. | | A | | Cutoff Allow. B | | H Hex | C | J Hex | |
|-------------|-------------|-----------|----|------|-----|-----------------|----|-------|------|-------|-------|
| | | inch | mm | inch | mm | inch | mm | inch | inch | inch | |
| 1JSCG-4-4 | 9/16-18 | 1/4 | 6 | 2.42 | 61 | 1-1/4 | 32 | 5/8 | .32 | 8 | 11/16 |
| 1JSCG-6-6 | 11/16-16 | 3/8 | 10 | 2.73 | 69 | 1-5/16 | 33 | 11/16 | .34 | 9 | 13/16 |
| 1JSCG-8-6 | 13/16-16 | 3/8 | 10 | 3.00 | 76 | 1-5/8 | 41 | 7/8 | .43 | 11 | 15/16 |
| 1JSCG-12-12 | 1-3/16-12 | 3/4 | 19 | 4.29 | 109 | 2 | 51 | 1-1/4 | .55 | 14 | 1-3/8 |
| 1JSCG-16-16 | 1-7/16-12 | 1 | 25 | 4.99 | 127 | 2-3/16 | 56 | 1-3/4 | .56 | 14 | 1-5/8 |

NOTE: When measuring overall length to the end of the nut, B+C dimensions must be used to calculate cut-off allowance

1L9CG Female JIC 37° Swivel 90° Elbow Special Drop

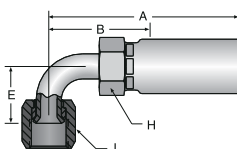

Construction: Steel. Add "C" for Stainless Steel.

| Part Number | Thread Size | Hose I.D. | | A | | Cutoff Allow. B | | E | | H Hex | J Hex |
|-------------|-------------|-----------|----|------|----|-----------------|----|------|----|-------|-------|
| | | inch | mm | inch | mm | inch | mm | inch | mm | inch | inch |
| 1L9CG-4-4 | 7/16-20 | 1/4 | 6 | 2.47 | 63 | 1-3/8 | 35 | 0.88 | 22 | 5/8 | 9/16 |
| 1L9CG-6-6 | 9/16-18 | 3/8 | 10 | 2.88 | 73 | 1-7/16 | 36 | 1.12 | 28 | 3/4 | 11/16 |

1TUCG Universal Tube Stub

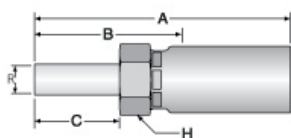

Construction: Stainless Steel.

| Part Number | Diameter R | Hose I.D. | | A | | Cutoff Allow. B | | C | | H Hex |
|--------------|------------|-----------|----|------|-----|-----------------|----|------|----|-------|
| | | inch | mm | inch | mm | inch | mm | inch | mm | inch |
| 1TUCG-4-4C | 1/4 | 1/4 | 6 | 2.60 | 66 | 1-1/2 | 38 | 0.72 | 38 | 0.72 |
| 1TUCG-6-6C | 3/8 | 3/8 | 10 | 2.91 | 74 | 1-1/2 | 38 | 0.78 | 38 | 0.78 |
| 1TUCG-8-8C | 1/2 | 1/2 | 13 | 3.35 | 85 | 1-13/16 | 46 | 1.03 | 46 | 1.03 |
| 1TUCG-12-12C | 3/4 | 3/4 | 19 | 4.18 | 106 | 1-7/8 | 48 | 1.03 | 48 | 1.03 |
| 1TUCG-16-16C | 1 | 1 | 25 | 5.14 | 131 | 2-3/8 | 60 | 1.36 | 60 | 1.36 |

NOTE: Use with A-Lok & CPI nuts, sleeves and adapters. These components are manufactured by Parker's Instrumentation Connectors Division. Refer to catalog 4230/4233 for information.

WARNING

This product can expose you to chemicals including Lead, which is known to the State of California to cause cancer and birth defects or other reproductive harm. For more information go to www.P65Warnings.ca.gov.

Fittings - Permanent Crimp CY Series

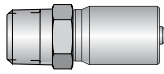
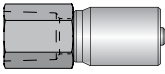
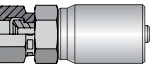
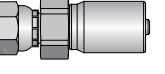
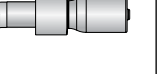
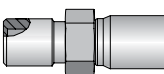
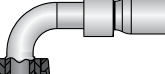
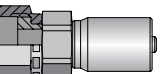
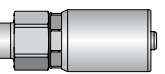
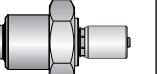
| CY Series | Permanent | | | | |
|---|---|--|---|---|--|
| | 101 Male Taper Pipe Rigid | 102 Female Pipe Thread | 106 Female SAE JIC 37° Swivel | 113 Male Pipe Swivel | 139 FM JIC 37° Swivel 90° Elbow Short |
|  |  |  |  |  | |
| E-77 | E-77 | E-78 | E-78 | E-78 | |
| 1GK Bulkhead w/Zerk Port Integrated | 1J9 Female Seal-Lok™ 90° Elbow Short | 1JC Female Seal-Lok™ Swivel Strt. Short | 1LM Male Grease | 1PD Integrated Bulkhead Diagnostic Nipple | |
|  |  |  |  |  | |
| E-79 | E-79 | E-78 | E-79 | E-79 | |

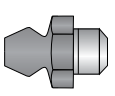
| 1GKCY Options | Nut | Zerk |
|---|---|---------|
| | 2GK-Nut | NA-6520 |
|  |  | |
| E-79 | E-79 | |

101CY Male Taper Pipe Rigid

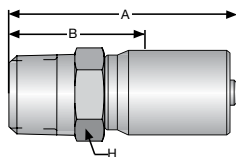

Construction: Steel. Add "C" for Stainless Steel.

| Part Number | Thread Size | Hose I.D. | | A | | Cutoff Allow. B | | H Hex inch |
|-------------|-------------|-----------|----|------|----|-----------------|----|------------|
| | | inch | mm | inch | mm | inch | mm | |
| 101CY-2-2 | 1/8-27 | 1/8 | 3 | 1.31 | 33 | 13/16 | 21 | 7/16 |
| 101CY-2-3 | 1/8-27 | 3/16 | 5 | 1.74 | 44 | 7/8 | 22 | 1/2 |
| 101CY-4-2 | 1/4-18 | 1/8 | 3 | 1.51 | 38 | 1 | 25 | 9/16 |
| 101CY-4-3 | 1/4-18 | 3/16 | 5 | 1.97 | 50 | 1-1/8 | 28 | 9/16 |

102CY Female Pipe Thread

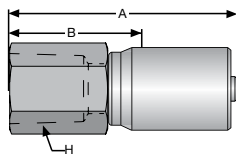

Construction: Steel. Add "C" for Stainless Steel.

| Part Number | Thread Size | Hose I.D. | | A | | Cutoff Allow. B | | H Hex inch |
|-------------|-------------|-----------|----|------|----|-----------------|----|------------|
| | | inch | mm | inch | mm | inch | mm | |
| 102CY-2-3 | 1/8-27 | 3/16 | 5 | 1.97 | 50 | 1-1/16 | 27 | 1/2 |

WARNING

This product can expose you to chemicals including Lead, which is known to the State of California to cause cancer and birth defects or other reproductive harm. For more information go to www.P65Warnings.ca.gov.

Fittings - Permanent Crimp CY Series

106CY Female SAE (JIC) 37° Swivel

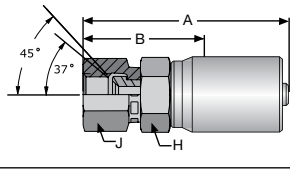

Construction: Steel. Add "C" for Stainless Steel.

| Part Number | Thread Size | Hose I.D. | | A | | Cutoff Allow. B | | H Hex inch | J Hex inch |
|-------------|-------------|-----------|----|------|----|-----------------|----|------------|------------|
| | | inch | mm | inch | mm | inch | mm | | |
| 106CY-2-2 | 5/16-24 | 1/8 | 3 | 1.52 | 39 | 15/16 | 24 | 7/16 | 7/16 |
| 106CY-3-2 | 3/8-24 | 1/8 | 3 | 1.53 | 39 | 1 | 25 | 1/2 | 1/2 |
| 106CY-4-2 | 7/16-20 | 1/8 | 3 | 1.59 | 40 | 1 | 25 | 9/16 | 9/16 |
| 106CY-4-3 | 7/16-20 | 3/16 | 5 | 1.99 | 50 | 1-1/8 | 29 | 9/16 | 9/16 |

NOTE: Size -4 incorporates a dual seat.

113CY Male Pipe Swivel*

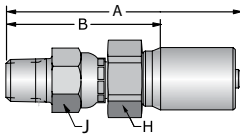

Construction: Steel. Add "C" for Stainless Steel.

| Part Number | Thread Size | Hose I.D. | | A | | Cutoff Allow. B | | H Hex inch | J Hex inch |
|-------------|-------------|-----------|----|------|----|-----------------|----|------------|------------|
| | | inch | mm | inch | mm | inch | mm | | |
| 113CY-2-2 | 1/8-27 | 1/8 | 3 | 1.89 | 48 | 1-5/16 | 33 | 1/2 | 1/2 |
| 113CY-2-3 | 1/8-27 | 3/16 | 3 | 2.29 | 58 | 1-7/16 | 36 | 1/2 | 1/2 |

NOTE: *Nitrile O-ring.

WARNING: Fittings allow minor movement to relieve stress on hose but are not recommended for continued or extensive swiveling.

139CY Female JIC 37° Swivel 90° Elbow Short Drop

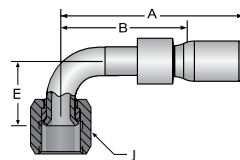

Construction: Steel. Add "C" for Stainless Steel.

| Part Number | Thread Size | Hose I.D. | | A | | Cutoff Allow. B | | E | | J Hex inch |
|-------------|-------------|-----------|----|------|----|-----------------|----|------|----|------------|
| | | inch | mm | inch | mm | inch | mm | inch | mm | |
| 139CY-4-2 | 7/16-20 | 1/8 | 3 | 1.61 | 41 | 1-1/16 | 27 | 0.83 | 21 | 9/16 |
| 139CY-4-3 | 7/16-20 | 3/16 | 5 | 1.90 | 48 | 1 | 25 | 0.83 | 21 | 9/16 |

1JCCY Female Seal-Lok™ Swivel Straight Short

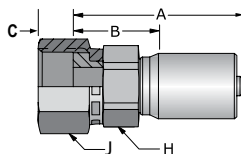

Construction: Steel. Add "C" for Stainless Steel.

| Part Number | Thread Size | Hose I.D. | | A | | Cutoff Allow. B | | C | | H Hex inch | J Hex inch |
|-------------|-------------|-----------|----|------|----|-----------------|----|------|----|------------|------------|
| | | inch | mm | inch | mm | inch | mm | inch | mm | | |
| 1JCCY-4-2 | 9/16-18 | 1/8 | 3 | 1.29 | 33 | 3/4 | 19 | 0.32 | 8 | 9/16 | 11/16 |

NOTE: When measuring overall length to the end of the nut, B+C dimensions must be used to calculate cut-off allowance.

WARNING

This product can expose you to chemicals including Lead, which is known to the State of California to cause cancer and birth defects or other reproductive harm. For more information go to www.P65Warnings.ca.gov.

Fittings - Permanent Crimp CY Series

1GKCY Bulkhead with Integrated Zerk Port Bulkhead Nut and Grease Zerk

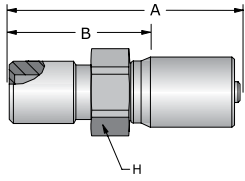

Construction: Steel. Add "C" for Stainless Steel.

| Part Number | Thread Size | Hose I.D. | | A | | Cutoff Allow. B | | H Hex inch |
|---------------|---|-----------|----|------|----|-----------------|----|------------|
| | | inch | mm | inch | mm | inch | mm | |
| 1GKCY-2-2* | 1/8-27 NPSM Male with 1/4-28 UNF Female | 1/8 | 3 | 1.45 | 37 | 7/8 | 22 | 1/2 |
| 1GKCY-2-3* | 1/8-27 NPSM Male with 1/4-28 UNF Female | 3/16 | 5 | 1.86 | 47 | 1 | 25 | 1/2 |
| 1GKCY-2-L77** | 1/8-27 NPSM Male with 1/4-28 UNF Female | 1/8 | 3 | 1.71 | 43 | 1-1/4 | 32 | 1/2 |

NOTE: *Standard bulkhead for use with plates up to 1/4" thick. Uses 2GK-NUT, sold separately.
**Long bulkhead for use with plates under 3/4" thick. Uses 2GK-NUT, sold separately.

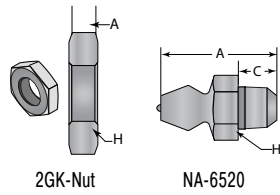

Construction: Steel.

| Part Number | Description | Thread Size | A | | C | | H Hex inch |
|-------------|----------------------|-------------|-------|------|------|-----|------------|
| | | | inch | mm | inch | mm | |
| 2GK-Nut | Bulk-head Nut | 1/8-27 NPSM | 0.125 | 4.8 | na | na | 9/16 |
| NA-6520 | Grease Zerk Fit-ting | 1/4-28 UNF | 0.540 | 13.7 | 0.18 | 4.6 | 5/16 |
| CY02-652317 | HLBD02 Spring Guard | - | - | - | - | - | - |
| 3PSG-4 | HLB03 Spring Guard | - | - | - | - | - | - |

1J9CY Female Seal-Lok™ 90° Elbow Short Drop

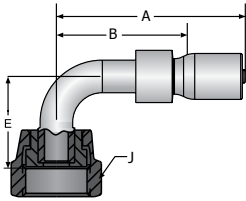

Construction: Steel. Add "C" for Stainless Steel.

| Part Number | Thread Size | Hose I.D. | | A | | Cutoff Allow. B | | E | | J Hex inch |
|-------------|-------------|-----------|----|------|----|-----------------|----|------|----|------------|
| | | inch | mm | inch | mm | inch | mm | inch | mm | |
| 1J9CY-4-2 | 9/16-18 | 1/8 | 3 | 1.81 | 46 | 1-1/4 | 32 | .83 | 21 | 11/16 |

1LMCY Male Grease

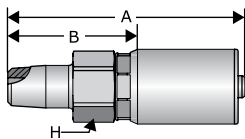

Construction: Steel. Add "C" for Stainless Steel.

| Part Number | Thread Size | Hose I.D. | | A | | Cutoff Allow. B | | H Hex inch |
|-------------|-------------|-----------|----|------|----|-----------------|----|------------|
| | | inch | mm | inch | mm | inch | mm | |
| 1LMCY-2-2 | 1/4-28 | 1/8 | 3 | 1.26 | 32 | 11/16 | 17 | 3/8 |

1PDCY Integrated Bulkhead Diagnostic Nipple

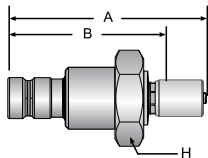

Construction: Steel. Add "C" for Stainless Steel.

| Part Number | Thread Size | Hose I.D. | | A | | Cutoff Allow. B | | H Hex inch |
|-------------|-------------|-----------|----|------|----|-----------------|----|------------|
| | | inch | mm | inch | mm | inch | mm | |
| 1PDCY-2-2 | 3/4"-16 UNF | 1/8 | 3 | 2.40 | 61 | 1.875 | 48 | 1 |

WARNING

This product can expose you to chemicals including Lead, which is known to the State of California to cause cancer and birth defects or other reproductive harm. For more information go to www.P65Warnings.ca.gov.

Fittings - Permanent Crimp

MS Series

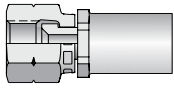
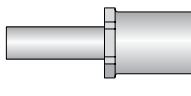
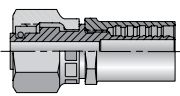
| MS Series | 108 SAE 45° Swivel | 134 Straight Tube | 1TF Marine Tube Connector |
|-----------|---|---|---|
| Permanent |  E-80 |  E-80 |  E-80 |

NOTE: MS Series is also available in a field-attachable design. The fittings are listed with the field-attachable fittings, page E-32.

108MS Permanent SAE 45° Swivel (Brass)

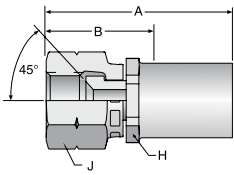

| Part Number | Thread Size | Hose I.D. | | A | | Cutoff Allow. B | | H Hex inch | J Hex inch |
|-------------|-------------|-----------|----|------|----|-----------------|----|------------|------------|
| | | inch | mm | inch | mm | inch | mm | | |
| 108MS-6-5B | 5/8-18 | 5/16 | 8 | 1.75 | 45 | 1-1/8 | 29 | 5/8 | 13/16 |
| 108MS-6-6B | 5/8-18 | 3/8 | 10 | 1.82 | 46 | 1-1/16 | 27 | 3/4 | 13/16 |

Construction: Brass.

134MS Permanent Straight Tube (Brass)

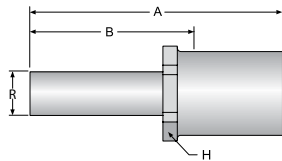

| Part Number | Diameter R | Hose I.D. | | A | | Cutoff Allow. B | | H Hex inch |
|-------------|------------|-----------|----|------|----|-----------------|----|------------|
| | | inch | mm | inch | mm | inch | mm | |
| 134MS-6-5B | 3/8 | 5/16 | 8 | 2.00 | 51 | 1-3/8 | 35 | 5/8 |
| 134MS-6-6B | 3/8 | 3/8 | 10 | 2.08 | 53 | 1-3/8 | 35 | 3/4 |

Construction: Brass.

1TFMS Permanent Marine Tube Connector (Brass)

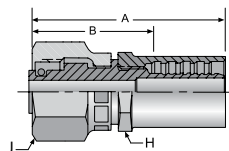

| Part Number | Thread Size | Hose I.D. | | A | | Cutoff Allow. B | | J Hex inch | H Hex inch |
|-------------|-------------|-----------|----|------|----|-----------------|----|------------|------------|
| | | inch | mm | inch | mm | inch | mm | | |
| 1TFMS-6-5B | 9/16-24 | 5/16 | 8 | 1.70 | 43 | 1 1/16 | 27 | 3/4 | 5/8 |

NOTE: Nitrile O-ring.

Construction: Brass.

Connector Mates are Manufactured by the Fluid Systems Connection Division. Refer to Catalog 3501E for Ordering, Installation Instructions and Replacement Components.

WARNING

This product can expose you to chemicals including Lead, which is known to the State of California to cause cancer and birth defects or other reproductive harm. For more information go to www.P65Warnings.ca.gov.

Fittings - Permanent Crimp SF Series

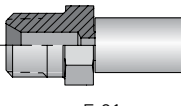
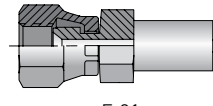
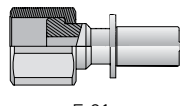
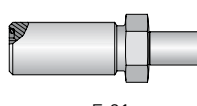
| SF Series | 101 | 106 | 1JS | 1JB |
|-----------|---|---|---|---|
| Permanent | Male Taper Pipe Rigid | JIC 37° Swivel | Female Seal-Lok™ Swivel Long | Male Seal-Lok™ Bulkhead w/O-ring |
| |  E-81 |  E-81 |  E-81 |  E-81 |

101SF Male Taper Pipe Rigid

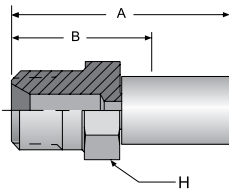

Construction: Steel. Add "C" for Stainless Steel.

| Part Number | Thread Size | Hose I.D. | | A | | Cutoff Allow. B | | H Hex |
|-------------|-------------|-----------|-----|------|----|-----------------|----|-------|
| | | inch | mm | inch | mm | inch | mm | inch |
| 101SF-2-1 | 1/8-27 | 0.090 | 2.3 | 1.13 | 29 | 3/4 | 19 | 7/16 |

106SF JIC 37° Swivel

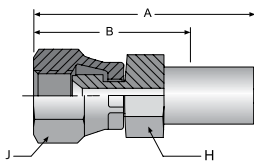

Construction: Steel. Add "C" for Stainless Steel.

| Part Number | Thread Size | Hose I.D. | | A | | Cutoff Allow. B | | H Hex | J Hex |
|-------------|-------------|-----------|-----|------|----|-----------------|----|-------|-------|
| | | inch | mm | inch | mm | inch | mm | inch | inch |
| 106SF-2-1 | 5/16-24 | 0.090 | 2.3 | 1.37 | 35 | 15/16 | 24 | 7/16 | 1/2 |

1JSSF Female Seal-Lok™ Swivel Long

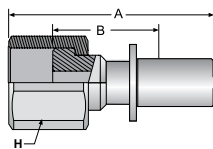

Construction: Steel. Add "C" for Stainless Steel.

| Part Number | Thread Size | Hose I.D. | | A | | Cutoff Allow. B | | H Hex |
|-------------|-------------|-----------|-----|------|------|-----------------|----|-------|
| | | inch | mm | inch | mm | inch | mm | inch |
| 1JSSF-4-1 | 9/16-18 | 0.090 | 2.3 | 1.18 | 29.8 | 3/4 | 19 | 11/16 |

1JBSF Male Seal-Lok™ Bulkhead with O-ring

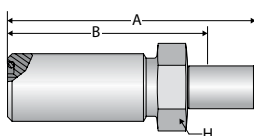

Construction: Steel. Add "C" for Stainless Steel.

| Part Number | Thread Size | Hose I.D. | | A | | Cutoff Allow. B | | H Hex |
|-------------|-------------|-----------|-----|------|----|-----------------|----|-------|
| | | inch | mm | inch | mm | inch | mm | inch |
| 1JBSF-4-1 | 9/16-18 | 0.090 | 2.3 | 2.06 | 52 | 1-11/16 | 43 | 5/8 |

NOTE: Bulkhead Locknut sold separately.
WNL Locknuts are manufactured by the Tube Fittings Division. Refer to Catalog 4300 for information.

WARNING

This product can expose you to chemicals including Lead, which is known to the State of California to cause cancer and birth defects or other reproductive harm. For more information go to www.P65Warnings.ca.gov.

Fittings - Permanent Crimp SQ Series

A Hose

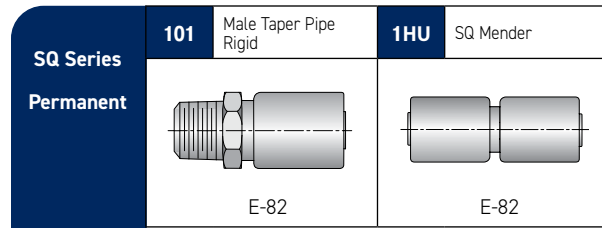

B Tubing Thermoplastic

C Coiled Air Hose & Fittings

101SQ Male Taper Pipe Rigid

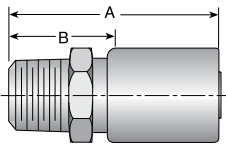

Construction: Steel.

| Part Number | | Hose I.D. | | A | | Cutoff Allow. B | |
|-------------|-------------|-----------|----|------|----|-----------------|----|
| Hose | Fitting | inch | mm | inch | mm | inch | mm |
| S612 | 101SQ-12-12 | 3/4 | 19 | 3.08 | 78 | 1-1/2 | 38 |
| S616 | 101SQ-16-16 | 1 | 25 | 3.42 | 87 | 1-13/16 | 46 |
| S912 | 101SQ-12-12 | 3/4 | 19 | 3.08 | 78 | 1-1/2 | 38 |
| S916 | 101SQ-16-16 | 1 | 25 | 3.42 | 87 | 1-13/16 | 46 |

NOTE: See pg. F-14 for swage die selection. See pg. G-16 for assembly instructions.

D Transportation

1HUSQ Mender

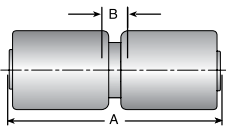

Construction: Steel.

| Part Number | | Hose I.D. | | A | | Cutoff Allow. B | |
|-------------|-------------|-----------|----|------|-----|-----------------|----|
| Hose | Fitting | inch | mm | inch | mm | inch | mm |
| S612 | 1HUSQ-12-12 | 3/4 | 19 | 3.7 | 94 | 9/16 | 14 |
| S616 | 1HUSQ-16-16 | 1 | 25 | 3.99 | 101 | 9/16 | 14 |
| S912 | 1HUSQ-12-12 | 3/4 | 19 | 3.7 | 94 | 9/16 | 14 |
| S916 | 1HUSQ-16-16 | 1 | 25 | 3.99 | 101 | 9/16 | 14 |

NOTE: See pg. F-14 for swage die selection. See pg. G-16 for assembly instructions.

E Fittings

F Tooling, Equipment, & Accessories

G General Technical

WARNING

This product can expose you to chemicals including Lead, which is known to the State of California to cause cancer and birth defects or other reproductive harm. For more information go to www.P65Warnings.ca.gov.



Tooling, Equipment & Accessories

Accessories
Crimpers

Pumps

Hose Guards

Table of Contents

CRIMPERS

MiniKrimp™F-4
 MiniKrimp™ Upgrade Kit.....F-5
 MiniKrimp Accessories.....F-6
 MiniKrimp Model Details & Parts.....F-8

Karrykrimp F-10
 Karrykrimp 2..... F-11

Parkrimp 2..... F-12

ACCESSORIES

Air Over Hydraulic Pumps.....F-13
 Electric Pumps.....F-14
 Hand Pumps.....F-13

Hose Guards.....F-16
 Hose Cutters.....F-19

Parkrimp DiesF-15
 Vise & Insertion BlocksF-15

SQ-101-SW Swager/MenderF-14

Visual Index







Crimpers and Crimper Accessories

| | | | | |
|--|---|---|---|---|
| Minikrimp 94C-001-PFD  F-4 | Minikrimp Hydraulic Pump Upgrade Kit  F-5 | Karrykrimp 82C-061L-PFD  F-10 | Karrykrimp Bench Mount 82C-KKB-PFD  F-10 | Karrykrimp 2 85C-061L-PFD  F-11 |
| Karrykrimp 2 Bench Mount 85C-KKB-PFD  F-11 | Parkrimp 2 83C-081-PFD  F-12 | Minikrimp Mounts  F-6 | Minikrimp High Pressure Hose Assemblies  F-6 | Minikrimp Hose Stand  F-7 |
| Minikrimp Replacement Connectors  F-7 | | | | |

Table of Contents

Visual Index

Pumps

| Hand Pump 015301 | Hand Pump 82C-0HP-PFD | Hand Pump 85C-0HP-PFD | Air/Hydraulic Pump 025399 | Air/Hydraulic Pump 82C-0AP |
|---|---|---|--|---|
|  |  |  |  |  |
| F-13 | F-13 | F-13 | F-13 | F-13 |
| Hand Pump 015301 | Hand Pump 82C-0HP-PFD | | | |
|  |  | | | |
| F-14 | F-14 | | | |

Sewer Hose Swager

| Swager Mender SQ-101-SW |
|---|
|  |
| F-14 |

Accessories

| Dies | Vise Blocks VBS & VBL | Insertion Block TH-9-1-xxx | Hose Guard PV Clear Vinyl | Hose Guard HBR |
|---|---|---|--|---|
|  |  |  |  |  |
| F-15 | F-15 | F-15 | F-16 | F-16 |
| Hose Guard 5CNG CNGG Guard Kit | Hose Guard PSG / SSG Pre-Made Spring | Hose Guard -SG Pre-made | Hose Guard PTFE -AS Hose Guard | Hose Guard PTFE -2613 Inter. Flat Spring Guard |
|  |  |  |  |  |
| F-16 | F-16 | F-17 | F-17 | F-17 |
| Hose Guard FS Fire Sleeve | Hose Guard PSG Parker Spiral Guard | Hose Cutoff Machine TH3-EM3-110V | Push-Lok Cut-Off 881540 | Hose Cutter HTC |
|  |  |  |  |  |
| F-17 | F-18 | F-19 | F-19 | F-19 |
| Hose Cutter TH11-1 | Plastic Tube Cutter PTC | PST - Parker Skive Tool | EVERTHAW™ Heated Hose Protection Sleeve | |
|  |  |  |  | |
| F-19 | F-20 | F-20 | F-17 | |

A Hose

B Tubing Thermoplastic

C Coiled Air Hose & Fittings

D Transportation

E Fittings

F Tooling, Equipment & Accessories

G General Technical

Crimpers

MiniKrimp™ Hand Pump and Air Over Hydraulic

Weighing in at a light 42 pounds,
the strongest portable crimper on the market.



Features

- Lightweight, portable, compact all-in-one unit
- Hand unit with pump weighs only 42 pounds; Air unit weighs 45 pounds
- 10,000 psi and 30+ tons of force
- No gauges to set - exclusive Parkalign™ feature positions the fitting correctly every time
- Removable pusher design for easy die change
- Hand pump easily removed for use with jumper hose for bench-mounted units (Part No. 015309)
- Air pump utilizes a rugged activation and release lever for greater durability with no additional power source required for operation and can operate with as little as 60 psi air pressure (60-100 psi, 9 CFM recommended)
- Capable of crimping a majority of thermoplastic, rubber, PTFE and specialty hoses up to 3/4" I.D.
- For use with 56, 91, 91N, 92, 93N, CG, CY, MS, SF, 43 and HY Series fittings
- Do not use this machine to assemble any size 56, CG, 93N or 43 series Stainless Steel fitting. Use a minimum of a 60 ton crimp machine such as the KarryKrimp II

Hand Pump Specifications PN 94C-001-PFD

- Dimensions: 6" Deep, 13" Wide, 15" High
- Weight: 42 lbs with hand pump
- Rating: 30 tons force@10,000 psi maximum
- Full Cycle Time: Approximately 30 seconds

Note: Hydraulic Fluid - Enerpac HF oil only

Air/Hydraulic Pump Specifications PN 94C-002-PFD

- Dimensions: 6" Deep, 12" Wide, 15" High
- Weight: 45 lbs with air/hydraulic pump
- Rating: 30 tons force@10,000 psi maximum
- Full Cycle Time: Approximately 30 seconds

Note: Hydraulic Fluid - Enerpac HF oil only

Notes

- Reference CrimpSource on-line for detailed crimp specifications - www.parker.com/crimpsource

Minikrimp Standard Equipment

| Part Number | | Description | Individual Part Number |
|-------------|-------------|-------------------------|------------------------|
| 94C-001-PFD | 94C-002-PFD | | |
| ● | ● | Base unit | 94C-080-PFD |
| ● | | Hand pump | 015301 |
| | ● | Air over hydraulic pump | 025399 |
| ● | ● | Silver die ring | 82C-R01-PFD |

The MiniKrimp utilizes a one-piece, high-strength cast aluminum frame that is light, robust and highly corrosion resistant.

WARNING

This product can expose you to chemicals including Lead, which is known to the State of California to cause cancer and birth defects or other reproductive harm. For more information go to www.P65Warnings.ca.gov.

Crimpers

Air Over Hydraulic Pump Upgrade Kit, Part #025411



1. (IF APPLICABLE) Relieve pressure from attached pump. Remove the hand pump and bent tube assembly from the body of the crimper. Do not remove the adapter (6-6 CTX-S) from the cylinder. This adapter will be used, with an orientation change, with the Air Over Hydraulic Pump.
2. Screw (or reorient) the 6-6 CTX-S adapter into the cylinder port and tighten until the fitting is facing in the upward direction. Do not loosen the adapter to reach the correct orientation as this may cause leakage.
3. Apply appropriate thread sealant to taper pipe thread of 6-2 CTX-S adapter and screw into pump (2-3 turns) so that the fitting (male JIC connection) is facing the direction of the fill cap.
4. Mount the pump 025399 to the right side of the crimper as shown in the image to the left using two 1/4" bolt holes on the top of the crimper. Note that only the top two bolt holes are used.
5. Attach the 025349 bent tube assembly to the two adapters. The longer of the two ends of the tube will attach to the pump. Tighten the nuts of bent tube to a minimum of 20 ft.-lbs or 2-1/2 Flats from Wrench Resistance.
 - MiniKrimp is ready for operation. Reference the Enerpac pump manual for operating instructions.

Minikrimp Air Over Hydraulic Pump Upgrade Kit 025411

| Part Number | Descriptions |
|--------------|--------------------------------|
| 025399 | Air over Hydraulic Pump |
| 025349 | Stainless Steel Tube Connector |
| 6-6 CTXS-PFD | Adapter |
| 6-2 CTXS-PFD | Adapter |

Refer to Catalog 4300 of the Parker Tube Fittings Division for Detail Assembly Instructions for the CTX Port Adapters referenced in Steps 2 and 3.

WARNING

This product can expose you to chemicals including Lead, which is known to the State of California to cause cancer and birth defects or other reproductive harm. For more information go to www.P65Warnings.ca.gov.

Crimpers

MiniKrimp™ Accessories

A Hose



Upright Vise Mount Part No. 015307

- Material - High Strength Steel
- Mount connects to the bottom of the MiniKrimp using (4) 3/8-16 18-8 SS SHCS 2.5" long bolts (not included)
- Once connected, the Minikrimp can be clamped into a vise for operation

B Tubing
Thermoplastic



Side Vise Mount Part No. 015736

- Material - High Strength Steel
- Mount connects to the side of the MiniKrimp using (4) 1/4-20 18-8 SS SHCS 1" long bolts (not included)
- Once connected, the Minikrimp can be clamped into a vise for operation

C Coiled Air Hose
& Fittings



Table Mount Part No. 015306

- Material - High Strength Steel
- Mount connects to the bottom of the MiniKrimp using (4) 3/8-16 18-8 SS SHCS 2.5" long bolts (not included)
- Once connected, the Minikrimp can be mounted to a table using the (4) 3/8" clearance holes on the opposite side of the plate (bolts not included)

D Transportation



High Pressure Hose Assembly Part No. 045234

- Parker 10,000 psi, 1/4" ID hose assembly with bend restrictors and 3000 series quick disconnects (PN - 2022N0101060404-36BR with 3050-2/3010-2 coupler and nipple)
- Designed to be used when mounting a hand pump (015301) to the MiniKrimp stand (94C-MKS) base

E Fittings

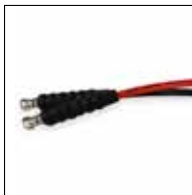

High Pressure Hose Assembly Part No. 015309

- Parker 10,000 psi, 1/4" I.D. hose assembly with 3/8" female JIC connections and bend restrictors on both ends (PN - 2022N0606060604-72BR)
- Hose is used when a flexible connection is required between the MiniKrimp and a hydraulic pressure source.

- Note: The hydraulic connectors shown on this page are designed exclusively for use with the MiniKrimp. No other connectors are approved for use with the MiniKrimp without expressed written consent from Parker Parflex Division's technical support. Any worn connectors should be replaced immediately.

WARNING

This product can expose you to chemicals including Lead, which is known to the State of California to cause cancer and birth defects or other reproductive harm. For more information go to www.P65Warnings.ca.gov.

F General Technical

Crimpers

MiniKrimp™ Accessories



Folding Stand Part No. 94C-MKS

- Lightweight folding stand designed exclusively for the MiniKrimp portable crimper
- Fold up design is easy to store
- Mounting hardware and safety instructions are included
- Patented design



Hand Pump Replacement Connector Part No. 015308

- Replacement stainless-steel bent tube rigid connector
- For use with 94C-001-PFD (MiniKrimp Hand Pump Model)



Air Over Hydraulic Replacement Connector Part No. 025349

- Replacement stainless-steel bent tube rigid connector
- For use with 94C-002-PFD (MiniKrimp Air Over Hydraulic Model)



MiniKrimp with Hand Pump



Hand Pump MiniKrimp



Air Over Hydraulic MiniKrimp
and Folding Stand

- Note: The hydraulic connectors shown on this page are designed exclusively for use with the MiniKrimp. No other connectors are approved for use with the MiniKrimp without expressed written consent from Parker Parflex Division's technical support. Any worn connectors should be replaced immediately.



WARNING

This product can expose you to chemicals including Lead, which is known to the State of California to cause cancer and birth defects or other reproductive harm. For more information go to www.P65Warnings.ca.gov.

Crimpers

MiniKrimp™ Detail - Hand Pump

A Hose

B Tubing Thermoplastic

C Coiled Air Hose & Fittings

D Transportation

E Fittings

F Tooling, Equipment, & Accessories

G General Technical

Hand Pump Model Details & Part List

| Part No. | Description | Qty. |
|-------------|--------------------------------|------|
| 015301 | 2 Speed Light Weight Hand Pump | 1 |
| 015302 | Hardened Steel Sleeve | 1 |
| 015303 | Custom Cylinder | 1 |
| 015304 | Aluminum Frame | 1 |
| 015305 | Cup Pusher | 1 |
| 015306 | Bent Tube Assembly | 1 |
| 015310 | 3/8" x 3/8" Shoulder Bolt | 1 |
| 015415 | Spring Plunger | 1 |
| 6 CTX-S | 3/8" 37° to 1/4" NPT Elbow | 1 |
| 6-6 CTX-S | 3/8" 37° to 3/8" NPT Elbow | 1 |
| 822011 | Die Separator | 1 |
| 822012 | Spring | 1 |
| 822031 | Retention Ring | 1 |
| 82C-R01-PFD | Silver Die Ring | 1 |
| 015411 | 3/8-16 18-8 SS SHCS 2.5" Long | 2 |
| 015413 | 1/4-20 18-8 SS Lock Washer | 2 |
| 015414 | 1/4-20 18-8 SS Flat Washer | 2 |
| 015412 | 1/4-20 18-8 SS SHCS .75" Long | 4 |

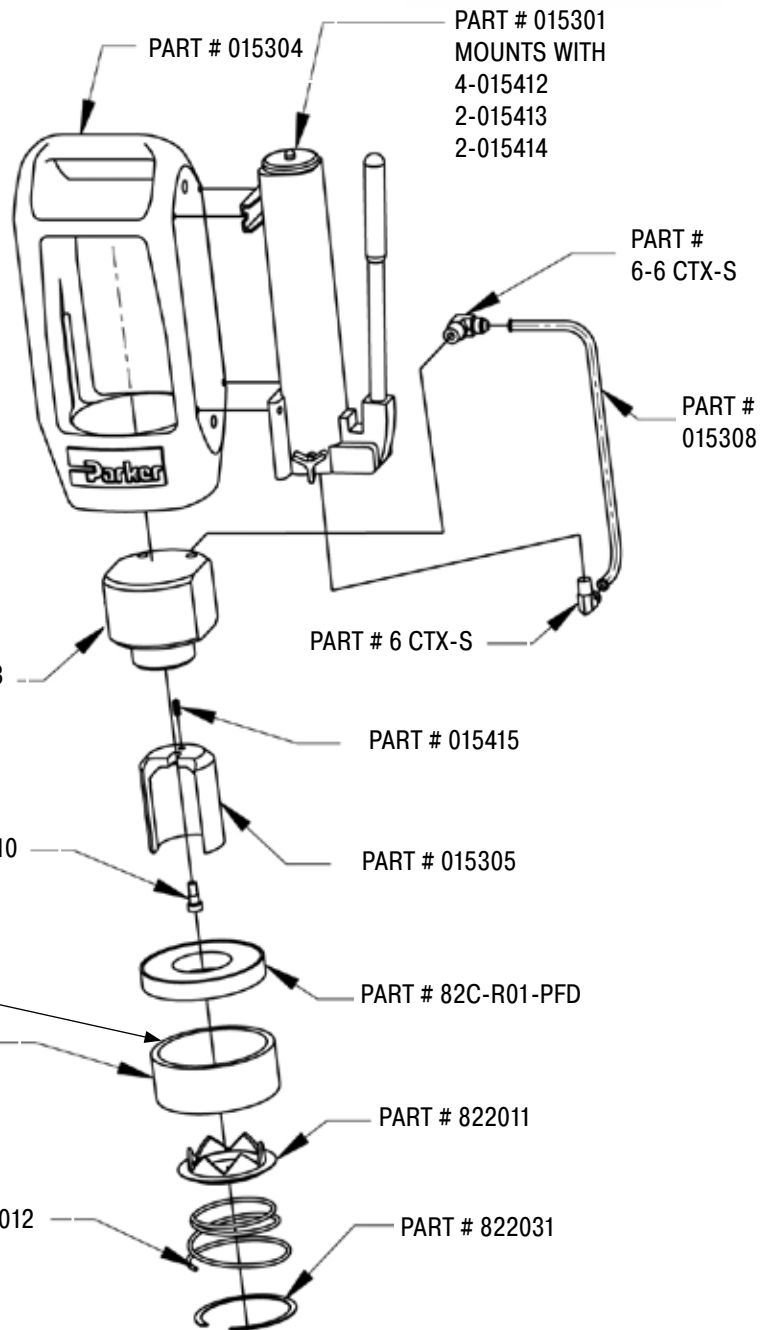

MiniKrimp™ Serial Number

WARNING

This product can expose you to chemicals including Lead, which is known to the State of California to cause cancer and birth defects or other reproductive harm. For more information go to www.P65Warnings.ca.gov.

Crimpers

MiniKrimp™ Detail - Air Over Hydraulic

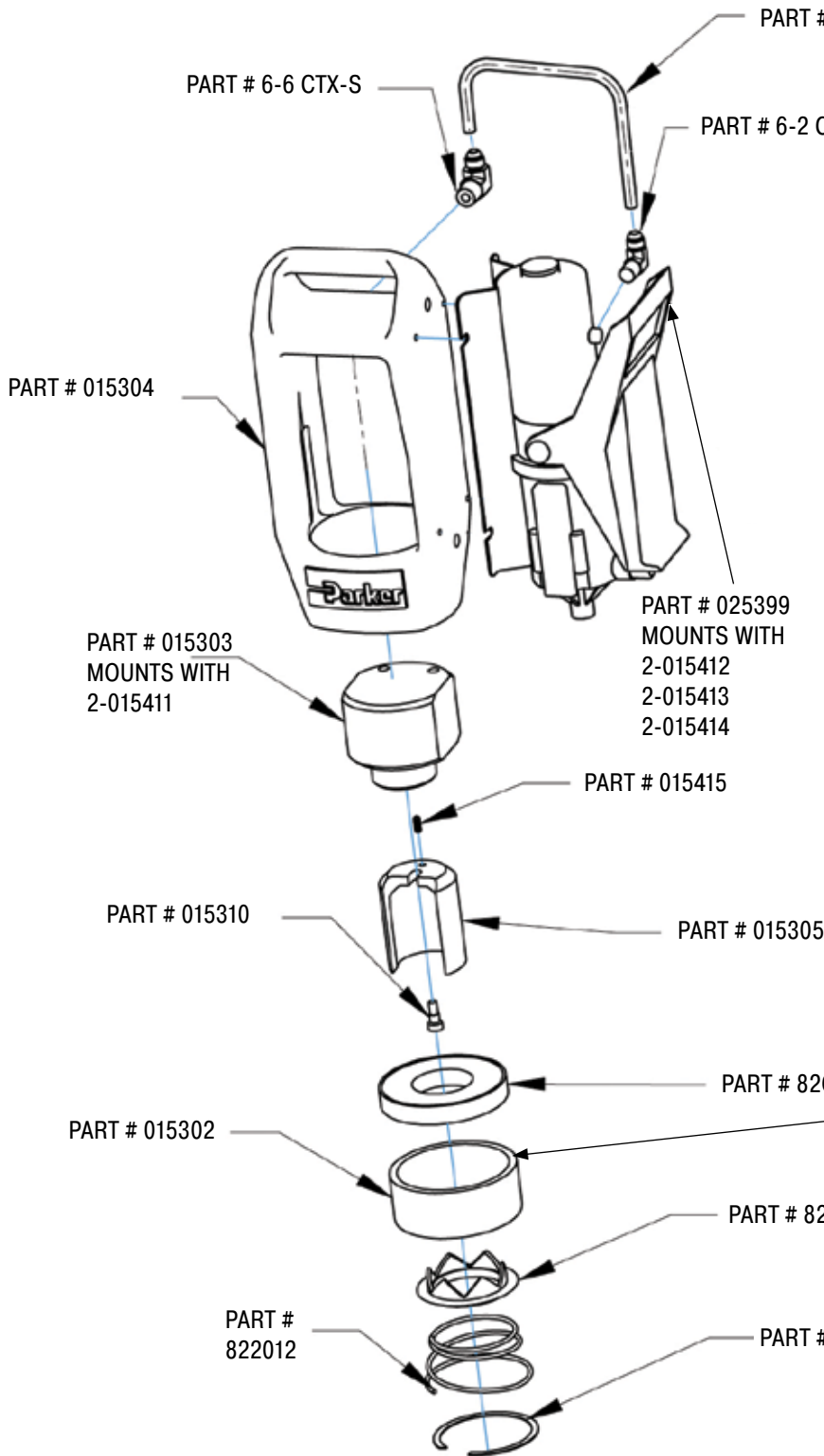

Hand Pump Model Details & Part List

| Part No. | Description | Qty. |
|-------------|-------------------------------|------|
| 015302 | Hardened Steel Sleeve | 1 |
| 015303 | Custom Cylinder | 1 |
| 015304 | Aluminum Frame | 1 |
| 015305 | Cup Pusher | 1 |
| 015310 | 3/8" x 3/8" Shoulder Bolt | 1 |
| 015415 | Spring Plunger | 1 |
| 6-2 CTX-S | 3/8" 37° to 1/8" NPT Elbow | 1 |
| 6-6 CTX-S | 3/8" 37° to 3/8" NPT Elbow | 1 |
| 822011 | Die Separator | 1 |
| 822012 | Spring | 1 |
| 822031 | Retention Ring | 1 |
| 82C-R01-PFD | Silver Die Ring | 1 |
| 015411 | 3/8-16 18-8 SS SHCS 2.5" Long | 2 |
| 015413 | 1/4-20 18-8 SS Lock Washer | 2 |
| 015414 | 1/4-20 18-8 SS Flat Washer | 2 |
| 015412 | 1/4-20 18-8 SS SHCS .75" Long | 2 |
| 025349 | Bent Tube Assembly | 1 |
| 025399 | Air Powered Pump | 1 |

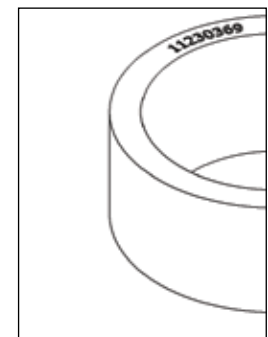

MiniKrimp™ Serial Number

WARNING

This product can expose you to chemicals including Lead, which is known to the State of California to cause cancer and birth defects or other reproductive harm. For more information go to www.P65Warnings.ca.gov.

A Hose

B Tubing Thermoplastic

C Coiled Air Hose & Fittings

D Transportation

E Fittings

F Tooling, Equipment & Accessories

G General Technical

Crimpers

Karrykrimp

Bench mounted design features fastest cycle time.



Features

- Portable, compact rugged design
- Compact bench mount design features faster cycle times
- Numerous portable power unit options available
- Pivoting pusher design for easy die change out
- Increased height enables longer bent tube fittings to be crimped
- Crimps most hoses up to 1-1/4 I.D.
- For use with 56, 91, 91N, 92, 93N, CG, CY, MS, SF, 43 and HY Series fittings
- **Do not** use this machine to assemble any size 56, CG, 93N or 43 series Stainless Steel fitting. Use a minimum of a 60 ton crimp machine such as the KarryKrimp II

Portable Unit Specifications PN 82C-061L-PFD

- Dimensions: 12" Deep, 15" Wide, 30" High
- Weight: 70 lbs with power unit
- Rating: 30 tons force@10,000 psi maximum
- Full Cycle Time: 30 seconds

Bench Mounted Unit Specifications PN 82C-KKB-PFD

- Dimensions: 23" Deep, 19" Wide, 27-1/2" High
- Weight: 220 lbs
- Rating: 30 tons force@10,000 psi maximum
- Full Cycle Time: 15 seconds
- Hydraulic Fluid: Enerpac HF oil only

Notes

- *Mounted unit is designed to make about 200 crimps per day and is not designed to be a production crimper. Exceeding these suggested production amounts will significantly reduce the life expectancy of the crimper components
- Motor is dual voltage, 50/60hz suitable for 208-230/115v. Motor can be rewired by a qualified electrician to operate at alternate voltage
- Reference CrimpSource on-line for detailed crimp specifications - www.parker.com/crimpsource

Karrykrimp Standard Equipment

| Crimper Part Number | | | Description | Individual Part Number |
|---------------------|--------------|-------------|---------------------------|------------------------|
| 82C-CHD-PFD | 82C-061L-PFD | 82C-KKB-PFD | | |
| ● | ● | ● | Crimp Head | 82C-CHD-PFD |
| | | ● | Bench Power Unit Assembly | 85C-ZMS-PFD |
| ● | ● | ● | Silver Die Ring | 82C-R01-PFD |
| ● | ● | ● | Black Die Ring | 82C-R02-PFD |
| | ● | | Hose Assembly | 85C-00L-PFD |
| | ● | | Stand Assembly | 85C-STD-PFD |
| | | ● | Hose Assembly | 85C-03L-PFD |

WARNING

This product can expose you to chemicals including Lead, which is known to the State of California to cause cancer and birth defects or other reproductive harm. For more information go to www.P65Warnings.ca.gov.

Crimpers

Karrykrimp 2

The same unit now offers portability and bench mountability.



Features

- Portable, compact rugged design
- Bench mount design features faster cycle times
- Numerous portable power unit options available
- Pivoting pusher design for easy die change out
- Crimps most hoses up to 1-1/4 I.D.
- For use with 56, 91, 91N, 92, 93N, CG, CY, MS, SF, 43 and HY Series fittings

Portable Unit Specifications PN 85C-061L-PFD

- **Dimensions:** 14" Deep, 14" Wide, 31-1/2" High
- **Weight:** 120 lbs without power unit
- **Rating:** 60 tons force@10,000 psi maximum
- **Full Cycle Time:** 15 seconds

Bench Mounted Unit Specifications PN 85C-KKB-PFD

- **Dimensions:** 24" Deep, 19" Wide, 28" High
- **Weight:** 265 lbs
- **Rating:** 60 tons force@10,000 psi maximum
- **Full Cycle Time:** 15 seconds
- **Hydraulic Fluid:** Enerpac HF oil only

Notes

- *Mounted unit is designed to make about 400 crimps per day and is not designed to be a production crimper. Exceeding these suggested production amounts will significantly reduce the life expectancy of the crimper components
- Motor is dual voltage, 50/60hz suitable for 208-230/115v. Motor can be rewired by a qualified electrician to operate at alternate voltage
- Reference CrimpSource on-line for detailed crimp specifications - www.parker.com/crimpsource

Karrykrimp 2 Standard Equipment

| Crimper Part Number | | | Description | Individual Part Number |
|---------------------|--------------|-------------|---------------------------|------------------------|
| 85C-CHD-PFD | 85C-061L-PFD | 85C-KKB-PFD | | |
| ● | ● | ● | Crimp Head | 85C-CHD-PFD |
| | | ● | Bench Power Unit Assembly | 85C-ZMS-PFD |
| ● | ● | ● | Silver Die Ring | 85C-R01-PFD |
| ● | ● | ● | Black Die Ring | 85C-R02-PFD |
| | ● | | Hose Assembly | 85C-00L-PFD |
| | ● | | Stand Assembly | 85C-STD-PFD |
| | | ● | Hose Assembly | 85C-03L-PFD |



WARNING

This product can expose you to chemicals including Lead, which is known to the State of California to cause cancer and birth defects or other reproductive harm. For more information go to www.P65Warnings.ca.gov.

Crimpers

Parkrimp 2

Crimps hoses up to 2" I.D.



Features

- Easy to use vertical design
- Crimps full range of Parker hoses from 1/8" through 2" I.D.
- For use with 56, 91, 91N, 92, 93N, CG, CY, MS, SF, 43 and HY Series fittings

Unit Specifications PN 83C-081-PFD

- **Dimensions:** 24" Deep, 31" Wide, 77" High
- **Weight:** 842 lbs (Head is 558 lbs and base is 284 lbs)
- **Rating:** 125 ton force@5,000 psi maximum
- **Full Cycle Time:** 30 seconds without adapter bowl
20 seconds with adapter bowl
- **Hydraulic oil:** Enerpac HF oil only

Notes

- Reference CrimpSource on-line for detailed crimp specifications - www.parker.com/crimpsource

Parkrimp 2 Standard Equipment

| Crimper Part Number | | Description | Individual Part Number |
|---------------------|-------------|--|------------------------|
| 83C-081-PFD | 83C-082-PFD | | |
| ● | ● | Parkrimp 2 Crimper Head Assembly | 83C-080-PFD |
| ● | | Parkrimp 2 Stand Assembly with 230/460 volt, 3 phase, 50/60 Hz power unit (wired for 230 volt) | 83C-S40-PFD |
| | ● | Parkrimp 2 Stand Assembly with 230 volt, 1 phase, 50/60 Hz power unit | 83C-S20-PFD |
| ● | ● | Adapter Bowl | 83C-OCB-PFD |
| ● | ● | Spacer Ring | 83C-R02-PFD |
| ● | ● | Spacer Plates | 83C-R02H-PFD |

WARNING

This product can expose you to chemicals including Lead, which is known to the State of California to cause cancer and birth defects or other reproductive harm. For more information go to www.P65Warnings.ca.gov.

Accessories

Air/Hydraulic & Hand Pumps

Use only with the MiniKrimp



Air/Hydraulic Pump Part No. 025399

- Lightweight pump operates with 80-110 psi shop air pressure and delivers 10,000 psi
- Length: 13"
- Width: 4-1/2"
- Height: 5"
- Intake Port Size: 1/4" NPTF
- Output Port Size: 1/8" NPTF
- Weight: 12 lbs.
- Hydraulic Fluid: Enerpac oil only



Hand Pump Part No. 015301

- Ease of operation hand pump delivers 10,000 psi
- Length: 13-3/8"
- Width: 3-1/4"
- Height: 3-5/8"
- Port Size: 1/4" NPTF
- Weight: 4.7 lbs.
- Hydraulic Fluid: Enerpac oil only

Use with the MiniKrimp, Karrykrimp and Karrykrimp 2



Air/Hydraulic Pump Part No. 82C-0AP-PFD

- Lightweight pump operates with 80-110 psi shop air pressure and delivers 10,000 psi
- Length: 15"
- Width: 6"
- Height: 6"
- Intake Port Size: 1/4" NPTF
- Output Port Size: 3/8" NPTF
- Weight: 14 lbs.
- Hydraulic Fluid: Enerpac HF oil only



Hand Pump Part No. 82C-0HP-PFD

- Ease of operation hand pump delivers 10,000 psi
- Length: 23"
- Width: 4"
- Height: 5"
- Port Size: 3/8" NPTF
- Weight: 9.0 lbs.
- Hydraulic Fluid: Enerpac oil HF only



Hand Pump Part No. 85C-0HP-PFD

- Ease of operation hand pump delivers 10,000 psi
- Length: 29"
- Width: 13"
- Height: 11"
- Port Size: 3/8" NPTF
- Weight: 61 lbs.
- Hydraulic Fluid: Enerpac oil only



WARNING

This product can expose you to chemicals including Lead, which is known to the State of California to cause cancer and birth defects or other reproductive harm. For more information go to www.P65Warnings.ca.gov.

Accessories

Electric Pumps

Use with the MiniKrimp, Karrykrimp and Karrykrimp 2



Electric Part No. 82C-0EP-PFD

- Ease of operation electric pump delivers 10,000 psi
 - Length: 13" Weight: 31 lbs.
 - Width: 13" Hydraulic Fluid: Enerpac oil only
 - Height: 15" 115 volt, 1 phase, 50/60 Hz, 9 amp
 - Port Size: 3/8" NPTF



Electric Part No. 85C-0EP-PFD

- Heavy duty electric pump delivers 10,000 psi at a faster cycle time
 - Length: 19" Weight: 59 lbs.
 - Width: 11" Hydraulic Fluid: Enerpac oil only
 - Height: 17" 115 volt, 1 phase, 50/60 Hz, 20 amp
 - Port Size: 3/8" NPTF

Swagers

Swager/Mender



Swager/Mender Part No. SQ-101-SW

- Used for field assembly or repair on Predator S5N, S6 and S9 hoses

Swage Data For Sewer Cleaning Hose (SQ-101-SW SWAGE MACHINE ONLY)

| Hose Type. | Hose I.D. | Male Pipe | | | Mender/Splicer | | Swage O.D. +/- .015 inch | Swage Length inch |
|------------|-----------|---------------------|-----------------|--------------------|---------------------|-----------------|--------------------------|-------------------|
| | | Fitting Part Number | Die Part Number | Pusher Part Number | Fitting Part Number | Die Part Number | | |
| S508N | 1/2 | - | - | - | 1HU55-8-8 | SQ-101-08S5S | 0.850 | 0.750 |
| S612 | 3/4 | 101SQ-12-12 | SQ-101-12S6/S9 | SQ-101-12P | 1HUSQ-12-12 | SQ-101-12S6/S9 | 1.172 | 1.109 |
| S616 | 1 | 101SQ-16-16 | SQ-101-16S6 | SQ-101-16P | 1HUSQ-16-16 | SQ-101-16S6 | 1.445 | 1.156 |
| S912 | 3/4 | 101SQ-12-12 | SQ-101-12S6/S9 | SQ-101-12P | 1HUSQ-12-12 | SQ-101-12S6/S9 | 1.172 | 1.109 |
| S916 | 1 | 101SQ-16-16 | SQ-101-16S9 | SQ-101-16P | 1HUSQ-16-16 | SQ-101-16S9 | 1.488 | 1.156 |

Comments:

- Two dies required when swaging a mender/splicer fitting. A pusher is not required when swaging a mender/splicer fitting
- One die and one pusher required when swaging a male pipe fitting. For end fitting attachment, reference www.parker.com/crimpsource
- End fittings cannot be swaged on S5N series hose. Only mender/splicers can be swaged
- The information covered in the Swage Specification & Tool Selection Chart pertains to steel hose fittings. Swage diameter roundness shall not vary by more than .010". Swage diameters are measured in the center of the swage area. Parflex Division reserves the right to alter swage specifications.

WARNING

This product can expose you to chemicals including Lead, which is known to the State of California to cause cancer and birth defects or other reproductive harm. For more information go to www.P65Warnings.ca.gov.

Accessories

Parkrimp Dies



Parkrimp Dies

- Parkrimp dies, specifically engineered for thermoplastic and fluoropolymer hose:
 - Linked die segments
 - Pre-matched and assembled
 - Fitting size color coded

Colors

Color Code

| Size | Color |
|------|--------|
| -1.5 | Gray |
| -2 | Brown |
| -3 | Gray |
| -4 | Red |
| -5 | Purple |
| -6 | Yellow |
| -8 | Blue |
| -10 | Orange |
| -12 | Green |
| -16 | Black |
| -20 | White |
| -24 | Red |
| -32 | Green |

Approved Silver Die Rings

| Approved Die | Machine |
|--------------|--------------------------|
| NA* | Parkrimp 2 |
| 82C-R01-PFD | Karrykrimp and MiniKrimp |
| 85C-R01-PFD | Karrykrimp 2 |

* No additional silver die rings required.

Note: Parflex dies have been designed for use with the silver die ring. Silver die rings are to be used with all Parflex hoses unless otherwise specified.

For most Parker products, Crimp Die information and selection charts can be found online at www.parker.com/crimpsource.

Vise & Insertion Depth Blocks



Vise Blocks for Parflex Hose Sizes

| Part No. | Hose Size |
|----------|-----------|
| VBS | -2 1/8 |
| | -3 3/16 |
| | -4 1/4 |
| | -5 5/16 |
| | -6 3/8 |
| | -8 1/2 |

| Part No. | Hose Size |
|----------|-----------|
| VBL | -12 3/4 |
| | -16 1 |



Hose Insertion Depth Blocks Part No. TH9-1-xxx

| Part No. | Description |
|-----------------|-------------------------------|
| TH9-1-CG | CG Series. All sizes. |
| TH9-1-56 | 56 Series. All sizes. |
| TH9-1-91N | 91N Series. All sizes. |
| TH9-1-93N_20-32 | 93N Series. Sizes: -20 to -32 |
| TH9-1-93N_6-16 | 93N Series. Sizes: -6 to -16 |

| Part No. | Description |
|-------------|----------------------------|
| TH9-1-94_95 | 94 & 95 Series. All sizes. |
| TH9-1-CY_SF | CY & SF Series. All sizes. |
| TH9-1-MS | MS Series. All sizes. |
| TH9-1-HY | HY Series. All sizes. |

WARNING

This product can expose you to chemicals including Lead, which is known to the State of California to cause cancer and birth defects or other reproductive harm. For more information go to www.P65Warnings.ca.gov.

Accessories

Hose Guards

A Hose



PV - Clear Vinyl Hose Guard

| Part Number | Guard I.D. | | Standard Length | |
|-------------|------------|----|-----------------|-------|
| | inch | mm | feet | meter |
| PV97-1 | 0.44 | 11 | 100 | 30.5 |
| PV139-1 | 0.56 | 14 | 100 | 30.5 |
| PV1611-1 | 0.68 | 17 | 100 | 30.5 |

| Part Number | Guard I.D. | | Standard Length | |
|-------------|------------|----|-----------------|-------|
| | inch | mm | feet | meter |
| PV2014-1 | 0.87 | 22 | 50 | 15.2 |
| PV2420-1 | 1.25 | 32 | 50 | 15.2 |
| PV3224-1 | 1.5 | 38 | 50 | 15.2 |

B Tubing Thermoplastic



HBR - Hose Bend Restrictor (Black Elastomer)

| Part Number | Hose Size | | L | | D1 | | D2 | |
|-------------|-----------|----|------|-----|------|----|-------|----|
| | inch | mm | inch | mm | inch | mm | inch | mm |
| HBR-4 | 1/4 | 6 | 5 | 127 | 0.6 | 15 | 0.5 | 13 |
| HBR-6 | 3/8 | 10 | 6 | 152 | 0.64 | 16 | 0.625 | 16 |

- Parker reserves the right to change dimensions and performance parameters without notice

C Coiled Air Hose & Fittings



5CNG/5CNGLT - Black Vinyl CNG Hose Guard

| Hose Part No. | Hose Guard Part No. | Hose Part No. | Hose Guard Part No. |
|---------------|---------------------|----------------|---------------------|
| 5CNG-4 | CNGG5-4 | 5CNG/5CNGLT-12 | CNGG5-12 |
| 5CNG-6 | HBR-6 | 5CNG-16 | CNGG5-16 |
| 5CNG-8 | CNGG5-8 | | |

- Use with Parflex CNG hose

D Transportation

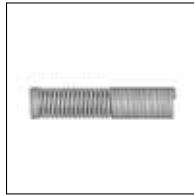

SSG Pre-made Spring Guards - Plated, hard-drawn steel wire

| Part Number | Guard I.D. | | Standard Length | |
|-------------|------------|----|-----------------|-----|
| | inch | mm | inch | mm |
| 55SSG-3 | 0.44 | 11 | 6 | 152 |
| 55SSG-4 | 0.55 | 14 | 6 | 152 |
| 55SSG-5 | 0.61 | 15 | 6 | 152 |

| Part Number | Guard I.D. | | Standard Length | |
|-------------|------------|----|-----------------|-----|
| | inch | mm | inch | mm |
| 55SSG-6 | 0.68 | 17 | 6 | 152 |
| 55SSG-8 | 0.83 | 21 | 6 | 152 |
| 55SSG-12 | 1.09 | 28 | 7 | 178 |

E Fittings

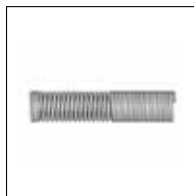

PSG Pre-made Spring Guards - For CNG Hose - Stainless Steel

| Part Number | Guard I.D. | | Standard Length | |
|-------------|------------|----|-----------------|-----|
| | inch | mm | inch | mm |
| 3PSG-4 | 0.54 | 14 | 6.25 | 159 |
| 5PSG-4 | 0.57 | 14 | 6.25 | 159 |

| Part Number | Guard I.D. | | Standard Length | |
|-------------|------------|----|-----------------|-----|
| | inch | mm | inch | mm |
| 5PSG-6 | 0.68 | 17 | 6.5 | 165 |
| 5PSG-8 | 0.90 | 23 | 6.5 | 165 |

WARNING

This product can expose you to chemicals including Lead, which is known to the State of California to cause cancer and birth defects or other reproductive harm. For more information go to www.P65Warnings.ca.gov.

F General Technical

G Tooling, Equipment, & Accessories

Accessories

Hose Guards

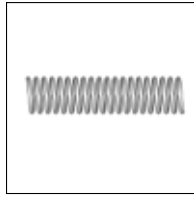

SG Pre-made Spring Guards - Plated, hard-drawn steel wire

| Part Number | Guard I.D. | | Standard Length | | Part Number | Guard I.D. | | Standard Length | |
|-------------|------------|----|-----------------|-------|-------------|------------|----|-----------------|-------|
| | inch | mm | feet | meter | | inch | mm | feet | meter |
| 55SG-3 | 0.47 | 12 | 25 | 7.6 | 55SG-6 | 0.67 | 17 | 25 | 7.6 |
| 55SG-4 | 0.55 | 14 | 25 | 7.6 | 55SG-8 | 0.83 | 21 | 25 | 7.6 |
| 55SG-5 | 0.61 | 16 | 25 | 7.6 | 55SG-12 | 1.09 | 28 | 10 | 3 |



Everthaw™ Heated Hose Protection Sleeve

| Part Number | Minimum O.D. Hose | | Maximum O.D. Hose | | Power Connection |
|-------------|-------------------|------|-------------------|------|------------------|
| | inch | mm | inch | mm | |
| 55SG-12 | 1 | 25.4 | 1-1/2 | 38/1 | 12V or 24V DC |

Hose Guards for PTFE Hose



AS

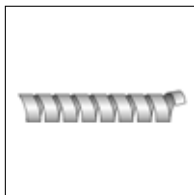

2613



FS

| Hose | Max O.D. inch | Partek Sleeve | Internal Flat Spring | Fire Sleeve |
|---------|---------------|---------------|----------------------|----------------------|
| 919/929 | -4 | 0.32 | - | FS-F-5 |
| | -5 | 0.40 | - | FS-F-7 |
| | -6 | 0.46 | AS-Y-11/AS-B-11 | FS-F-8 |
| | -8 | 0.56 | AS-Y-11/AS-B-11 | 2613-13CR FS-F-10 |
| | -10 | 0.66 | AS-Y-13/AS-B-13 | 2613-16CR FS-F-12 |
| | -12 | 0.79 | AS-Y-15/AS-B-15 | 2613-20CR FS-F-14 |
| | -16 | 1.05 | AS-Y-17/AS-B-17 | 2613-28CR FS-F-20 |
| 939 | -20 | 1.32 | AS-Y-22/AS-B-22 | 2613-37CR FS-F-24 |
| | -4 | 0.48 | AS-Y-11/AS-B-11 | FS-F-10 |
| | -6 | 0.59 | AS-Y-13/AS-B-13 | FS-F-11 |
| | -8 | 0.75 | AS-Y-15/AS-B-15 | FS-F-14 |
| | -10 | 0.88 | AS-Y-17/AS-B-17 | FS-F-16 |
| | -12 | 1.09 | AS-Y-19/AS-B-19 | FS-F-20 |
| | -16 | 1.33 | AS-Y-27/AS-B-27 | FS-F-24 |
| 943 | -20 | 1.75 | AS-Y-35/AS-B-35 | FS-F-32 |
| | -24 | 2.05 | AS-Y-39/AS-B-39 | FS-F-38 |
| | -32 | 2.56 | AS-Y-47/AS-B-47 | FS-F-48 |
| | -6 | 0.49 | AS-Y-11/AS-B-11 | FS-F-10 |
| | -8 | 0.62 | AS-Y-13/AS-B-13 | 2613-13CR FS-F-11 |
| 943 | -10 | 0.73 | AS-Y-15/AS-B-15 | 2613-16CR FS-F-14 |
| | -12 | 0.99 | AS-Y-17/AS-B-17 | 2613-20CR FS-F-18 |
| | -16 | 1.39 | AS-Y-27/AS-B-27 | 2613-28CR FS-F-24 |

NOTE: Partek sleeves come in yellow and black.

All internal guards are fabricated from 300 series stainless steel.

WARNING

This product can expose you to chemicals including Lead, which is known to the State of California to cause cancer and birth defects or other reproductive harm. For more information go to www.P65Warnings.ca.gov.

Accessories

PSG Hose Guard

Superior anti-crush performance.
Easy installation.



Features

- High-strength and resilient, Parflex Spiral Guard (PSG) protects hose and cable with superior anti-crush performance
- Exceptionally smooth facing and rounded edges prevent spiral guard from getting caught on rough surfaces
- Easy installation and routing
- Low friction interior minimizes wear on hose
- Delivers more advantages than cut pipe or sleeving at a competitive price or less
- For bundling, organizing and protecting hose and cable, PSG is the superior solution for mining operations
- PSG is available in:
 - An MSHA/FRAS approved version for underground mining
 - A standard version (with yellow stripe) for surface applications not requiring fire-resistant, anti-static properties
- Manufactured with high density polyethylene materials

PSG Hose Guard

| Part Number | Hose O.D. Range | | Package Qty. | | 1-Wire Braid Size | | 2-Wire Braid Size | | Multi-Spiral Size | | Weight | |
|-------------------------|-----------------|------------|--------------|------|-------------------|----------|-------------------|----------|-------------------|----------|----------|--------|
| | mm | inch | meter | feet | inch | mm | inch | mm | inch | mm | lbs./ft. | kg/mtr |
| PSG-12 | 10 – 13 | .394-.512 | 20 | 65.6 | - | - | - | - | - | - | 0.034 | 0.015 |
| PSG-FRAS-16 or PSG-16 | 12 – 17 | .472-.669 | 20 | 65.6 | 1/4 | 6 | 1/4 | 6 | - | - | 0.040 | 0.018 |
| PSG-FRAS-20 or PSG-20 | 16 – 22 | .630-.866 | 20 | 65.6 | 3/8 | 10 | 1/4 3/8 | 6 10 | 3/8 | 10 | 0.060 | 0.027 |
| PSG-FRAS-25 or PSG-25 | 22 – 28 | .866-1.10 | 20 | 65.6 | 1/2 5/8 | 13 16 | 1/2 5/8 | 13 16 | 1/2 5/8 | 13 16 | 0.101 | 0.046 |
| PSG-FRAS-32 or PSG-32 | 27 – 33 | 1.06-1.30 | 20 | 65.6 | 3/4 | 19 | 5/8 3/4 | 16 19 | 5/8 3/4 | 16 19 | 0.151 | 0.068 |
| PSG-FRAS-40 or PSG-40 | 33 – 42 | 1.30-1.65 | 20 | 65.6 | 1 | 25 | 1 | 25 | 1 | 25 | 0.235 | 0.107 |
| PSG-FRAS-50 or PSG-50 | 42 – 55 | 1.65-2.17 | 20 | 65.6 | 1-1/4 1-1/2 | 32 38 | 1-1/4 | 32 | 1-1/4 1-1/2 | 32 38 | 0.268 | 0.122 |
| PSG-FRAS-63 or PSG-63 | 52 – 65 | 2.05-2.56 | 20 | 65.6 | 2 | 51 | 1-1/2 | 38 | 1-1/2 | 38 | 0.402 | 0.182 |
| PSG-FRAS-75 or PSG-75 | 65 – 80 | 2.56-3.15 | 10 | 32.8 | - | - | 2 | 51 | 2 | 51 | 0.637 | 0.289 |
| PSG-FRAS-90 or PSG-90 | 80 – 150 | 3.15-5.91 | 10 | 32.8 | - | - | - | - | - | - | 0.771 | 0.350 |
| PSG-FRAS-110 or PSG-110 | 150 – above | 5.91-above | 10 | 32.8 | - | - | - | - | - | - | 1.000 | 0.454 |

WARNING

This product can expose you to chemicals including Lead, which is known to the State of California to cause cancer and birth defects or other reproductive harm. For more information go to www.P65Warnings.ca.gov.

Accessories

Cutters



Hose Cut-Off Machine Part No. TH3-EM3-110V-PFD

- Supplied with a vacuum port to remove smoke and debris while cutting
- Standard diamond-coated blade included
- Cuts wire reinforced hoses, including 6 heavy spiral constructions, up to 1-1/4" I.D.
- Dimensions: 17" wide x 21" long x 12" high
- Shipping Weight: 95 lbs.

| Part No. | Description | Individual Part No. |
|------------------|--|---------------------|
| TH3-EM3-110V-PFD | Hose Cut-Off Machine wired for 110-115 V | TH3-EM3-110V-PFD |



Push-Lok Cut-Off & Assembly Tool Part No. 881540-PFD

- Combines hose cutter and toggle action press
- Cuts and assembles Parker B9 and 83FR in sizes 1/4" through 3/4" I.D.



Hose & Tubing Cutter Part No. HTC

- Special V-block design with easy adjustable blade ensures a straight, clean cut
- Minimal flattening of hose/tubing during cutting - Straight, square cut enhances fitting retention
- Cuts up to 1" O.D. hose or tubing (Non-wire reinforced thermoplastic hose and tubing and rubber hose and tubing)
- Replacement blades: part no. HTC-RB



Hose Cut-Off Tool Part No. TH11-1-PFD

- Designed for quick, easy cutting of fiber reinforced hose
- Squarely cuts fiber reinforced hoses in sizes 1/4" through 3/4" I.D.



WARNING

This product can expose you to chemicals including Lead, which is known to the State of California to cause cancer and birth defects or other reproductive harm. For more information go to www.P65Warnings.ca.gov.

Cutters

MiniKrimp™ Accessories

A Hose



Plastic Tube Cutter Part No. PTC

- Razor-edged tube cutter
- Closes automatically, assuring clean and square cuts
- May be used with most plastic tubing up to 5/8" I.D.
- Replacement blades: part no. PTC-001-RB

B Tubing
Thermoplastic



Parflex Skive Tool Part No. PST

- Removes outer jacket on two layered construction tubing without damaging inner tube
- Use with Parflex 95FR tubing in sizes 1/4" through 1/2" I.D.

C Coiled Air Hose
& Fittings

D Transportation

E Fittings

F Tooling, Equipment,
& Accessories

G General Technical



WARNING

This product can expose you to chemicals including Lead, which is known to the State of California to cause cancer and birth defects or other reproductive harm. For more information go to www.P65Warnings.ca.gov.



General Technical

Instructions

Safety

Warranties

Table of Contents

A Hose

HOSE ASSEMBLY & CRIMPING

Using Crimpsource..... G-3

Permanent Crimp G-4
Series 56, CG, 92, CY, MS, SF

Field Attachable G-8
Series 51, 51R, BU, MS

PTFE Permanent Crimp G-9
Series 91, 91N, 93N

PTFE Permanent Crimp G-11
Series PAGE

PTFE Field Attachable..... G-13
Series 90

Sewer Hose Swaged G-15
Series SQ

HOSE HANDLING

Twin/Multi-Line Separation G-17

SAFETY/WARRANTIES

Parker Safety Guide G-19

Enerpac Warranty..... G-23

Offer of sale G-24

INDEX

By part number G-25

By keyword G-29



Parflex[®]
Partner. Innovator. Leader.

B Tubing
Thermoplastic

C Coiled Air Hose
& Fittings

D Transportation

E Fittings

F Tooling, Equipment,
& Accessories

G General Technical

Hose Assembly and Crimping

How To Use Crimpsource

1

Data



The most up-to-date information for crimping is located at www.parker.com/crimpsource. Not only is it accurate, but it is easy.

Note

- ✓ If the hose does not come up, then you cannot crimp that hose on the machine you selected.
- ✓ If the fitting/size you choose doesn't come up, then that series is not available for that hose.

www.parker.com/crimpsource

2

Make Your Selections

Machine:

Select

- Select
- Parkrimp 2
- Superkrimp
- Karrykrimp 1
- Karrykrimp 2
- Minikrimp
- Parkrimp 1
- Phastkrimp
- Adjustable
- CC25IS

Choose the correction machine.

Hose Style:

Select

- 518C
- 518D
- 520N
- 527BA
- 528N
- 538DM
- 53DM
- 540N
- 540P

Choose the hose you are crimping.

Note - If the hose does not come up, then the crimper chosen does not work with the selected hose.

Coupling Style:

Select

- 55
- 56
- 56H
- 57
- 58
- 81
- 91
- 91N
- 92
- 93N

Choose the fitting style.

Size:

All

- All
- 3
- 4
- 5
- 6
- 8
- 12
- All

Search

Choose the fittings size. Once you have selected values from each field, hit the search button.

Note - If the fitting/size does not come up, the series and or size is not available for the selected hose.

3

Review the Results

| Part Number | 80C-P08 | 82C-R01 | 0.850 | FULL | 1-1/8 | PKFull |
|-------------|---|---------|-------|------|-------|--------|
| Comments | <p>PFD: Crimp diameter is measured four places, 45 degrees apart, at the top, then middle and bottom of the crimp.</p> <p>PFD: Crimp diameter tolerance on all Parkrimp Crimpers is $\pm 0.010"$ ($\pm 0.25\text{mm}$) unless otherwise specified. Crimp length tolerance is $\pm 0.030"$ ($\pm 0.76\text{mm}$).</p> <p>PFD: Align measurement caliper or micrometer on the center of crimp impressions avoiding the crimp ribs.</p> <p>PFD: Crimp diameter tolerance on all Adjustable Crimpers is $\pm 0.005"$ ($\pm 0.13\text{mm}$). Crimp length tolerance is $\pm 0.030"$ ($\pm 0.76\text{mm}$).</p> | | | | | |

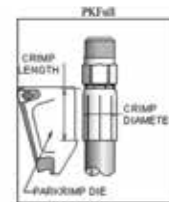

Hose Assembly and Crimping

Permanent Crimp - Series 56, CG, 92, CY, MS, SF

CAUTION

There are several sections for Hose Assembly and Crimping. Be sure you are in the section that corresponds to the fitting series you are using. See Table of Contents for listing.

A Hose

1

Inspection

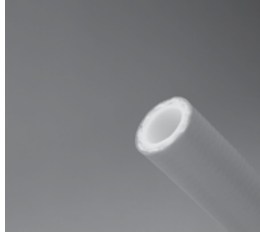

Hose - Visually inspect both ends of hose for square cut. Remove any burrs, loose fibers or wires.



Fittings - Verify fitting series corresponds to the selected hose. Visually inspect fitting(s) for a through-hole, threads and damage.

B Tubing Thermoplastic

2

Assembly Prep



Insertion Depth - Mark hose end with proper insertion depth line. Shown is a 56 Series fitting. See Hose Fitting Insertion Values, pg. E-10 for insertion depths of fitting series that do not incorporate an insertion depth.



Lubrication (as required) - Using an SAE 20 weight lubricating oil, lightly lubricate inside of hose end.

Warning Do not use lubricating oil when installing fittings on hose used in breathing air systems.

When installing fittings on hose used in breathing air systems, lubricate with a non-oil based soap solution as failure to do so may result in personal injury.

C Coiled Air Hose & Fittings

D Transportation

3

Assembly



Assemble Hose - Push hose into fitting all the way to depth insertion mark.

If fitting does not readily slide onto hose, perform the next step.



Using Parker VBS or VBL (vise blocks) and a rubber mallet, tap fitting onto hose until bottom of fitting shell is aligned with depth insertion mark.

E Fittings

4

Die Selection

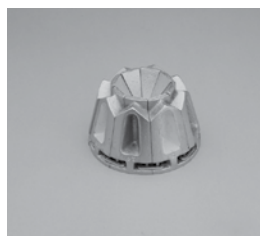

Select proper Parkrimp die set.

Reference Crimp Die Selection at Crimpsource online.

www.parker.com/crimpsource

5

Lubricate Bowl



Grease frequently using a premium, quality, lithium-based grease. Apply a thin layer of grease on bowl of crimper base plate.

F Tooling, Equipment, & Accessories

G General Technical

Hose Assembly and Crimping

Permanent Crimp - Series 56, CG, 92, CY, MS, SF

CAUTION

There are several sections for Hose Assembly and Crimping. Be sure you are in the section that corresponds to the fitting series you are using. See Table of Contents for listing.

Hose
A

6

Die and Spacer Ring



Crimp Die – Place die set into bowl.

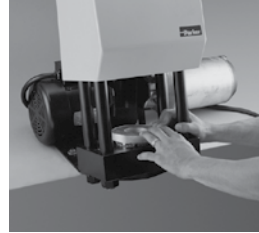

Die Ring – Place applicable die ring on top of crimp die. Position die ring so it is centered on the crimp die. Parflex utilizes the Silver die ring (8XC-R01) with limited exception.

Reference proper tooling (crimp die and die ring) at Crimpsource on-line.

www.parker.com/crimpsource

Tubing Thermoplastic
B

7

Crimp



Assemble Hose – Insert hose and fitting from bottom of crimper and up through die set. Position fitting so bottom of fitting skirt rests on die step (PARKALIGN® feature).

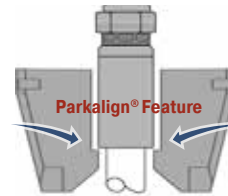

While holding hose and fitting in position on die step, crimp fitting onto hose until die ring contacts base plate.

Note - Pump on crimper must not exceed the rated pressure of the crimper being used. Parker Hannifin will not accept responsibility for the operation of or provide warranty coverage for a crimper that is operated by a power unit other than equipment supplied by Parker Hannifin for the express purpose of operating

Warning Keep fingers and hands away from die-pusher area. Failure to do so may result in personal injury.

Coiled Air Hose & Fittings
C

Transportation
D

Fittings
E

8

Measure & Inspect



Measure and verify hose assembly length.

Inspect insertion depth mark at fitting ends. Insertion mark must be visible but not exceed 1/8" from end of crimped fitting shell.



Measure crimp diameter of each fitting at the top, middle and bottom of the crimp shell. Take measurements at a minimum of three (3) places around the shell circumference.

Crimp acceptance is based on the middle measurement average with a maximum taper of 0.010" between the top and bottom crimp averages. No single measurement outside the specification is permissible.

Tooling, Equipment & Accessories
F

General Technical
G

Minikrimp Fitting Assembly

Permanent Crimp - Series 56, CG, 92, CY, MS, SF

CAUTION

There are several sections for Hose Assembly and Crimping. **Be sure you are in the section that corresponds to the fitting series you are using.** See Table of Contents for listing.

A Hose

1

Inspection

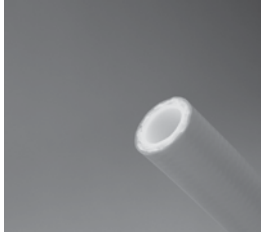

Hose - Visually inspect both ends of hose for square cut. Remove any burrs, loose fibers or wires.



Fittings - Verify fitting series corresponds to the selected hose. Visually inspect fitting(s) for a through-hole, threads and damage.

B Tubing Thermoplastic

2

Assembly Prep



Insertion Depth - Mark hose end with proper insertion depth line. Shown is a 56 Series fitting. See Hose Fitting Insertion Values, pg. E-10 for insertion depths of fitting series that do not incorporate an insertion depth.



Lubrication (as required) - Using an SAE 20 weight lubricating oil, lightly lubricate inside of hose end.

Warning Do not use lubricating oil when installing fittings on hose used in breathing air systems.

When installing fittings on hose used in breathing air systems, lubricate with a non-oil based soap solution as failure to do so may result in personal injury.

C Coiled Air Hose & Fittings

D Transportation

3

Assembly



Assemble Hose - Push hose into fitting all the way to depth insertion mark.

If fitting does not readily slide onto hose, perform the next step.



Using Parker VBS or VBL (vise blocks) and a rubber mallet, tap fitting onto hose until bottom of fitting shell is aligned with depth insertion mark.

E Fittings

4

Die Selection

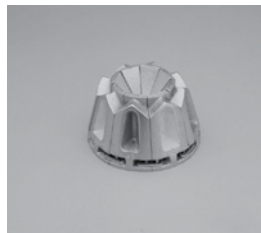

Select proper Parkrimp die set.

Reference Crimp Die Selection at Crimpsource online.

www.parker.com/crimpsource

5

Lubricate Bowl



Remove pusher from shoulder bolt.

Using a premium, quality, lithium-based grease, apply a thin layer of grease on bowl of crimper baseplate.

F Tooling, Equipment, & Accessories

G General Technical

Minikrimp Fitting Assembly

Permanent Crimp - Series 56, CG, 92, CY, MS, SF

CAUTION

There are several sections for Hose Assembly and Crimping. Be sure you are in the section that corresponds to the fitting series you are using. See Table of Contents for listing.

6

Die and Spacer Ring



Crimp Die – Place die set into bowl.

Replace pusher onto shoulder bolt.

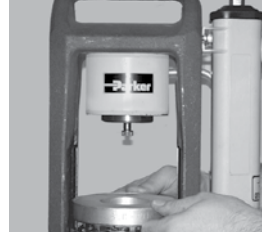

Die Ring – Place applicable die ring on top of crimp die. Position die ring so it is centered on the crimp die. Parflex utilizes the Silver die ring (8XC-R01) with limited exception.

Reference proper tooling (crimp die and die ring) at Crimpsource on-line. www.parker.com/crimpsource

7

Crimp



Assemble Hose – Insert hose and fitting from bottom of crimper and up through die set. Position fitting so bottom of fitting skirt rests on die step (PARKALIGN® feature).

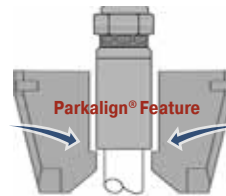

While holding hose and fitting in position on die step, crimp fitting onto hose until die ring contacts base plate.

Note – Pump on crimper must not exceed the rated pressure of the crimper being used. Parker Hannifin will not accept responsibility for the operation of or provide warranty coverage for a crimper that is operated by a power unit other than equipment supplied by Parker Hannifin for the express purpose of operating

Warning Keep fingers and hands away from die-pusher area. Failure to do so may result in personal injury.

8

Measure & Inspect



Measure and verify hose assembly length.

Inspect insertion depth mark at fitting ends. Insertion mark must be visible but not exceed 1/8" from end of crimped fitting shell.



Measure crimp diameter of each fitting at the top, middle and bottom of the crimp shell. Take measurements at a minimum of three (3) places around the shell circumference.

Crimp acceptance is based on the middle measurement average with a maximum taper of 0.010" between the top and bottom crimp averages. No single measurement outside the specification is permissible.

Hose
A

Tubing Thermoplastic
B

Coiled Air Hose & Fittings
C

Transportation
D

Fittings
E

Tooling, Equipment & Accessories
F

General Technical
G

Field Attachable Assembly

Series 51, 51R, BU, MS

CAUTION

There are several sections for Hose Assembly and Crimping. Be sure you are in the section that corresponds to the fitting series you are using. See Table of Contents for listing.

A Hose

1

Inspection

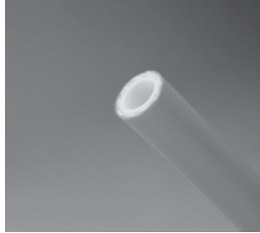

Hose - Visually inspect both ends of hose for square cut. Remove any burrs, loose fibers or wires.



Fittings - Inspect nipple for a through-hole, damaged or missing threads and improperly crimped nut (if applicable). Do not use if these conditions exist. Inspect socket for damaged or missing threads. Do not use if conditions exist.

B Tubing Thermoplastic

2

Assembly



Using the Parker VBS or VBL vise block, place hose in proper hole of the vise block and then clamp in a bench vise. Ensure enough hose extends from the vise block to install socket.

Caution Ensure hose is installed in correct size hole of vise block. Clamping hose in a smaller hole will crush hose.



Using a wrench or deep well socket with 51R, screw the socket onto the hose counterclockwise until it bottoms. Ensure end of hose is against inside shoulder. Back off socket 1/4 turn clockwise.

Socket should be firm when tightened but not difficult to install. If socket is difficult to install, apply lubricant that is compatible with the hose material.

C Coiled Air Hose & Fittings

The 51R Series Field-attachable fitting features an optional deep-well socket assembly procedure with either ratchet or power drill at low speed allowing for quick, power assist assembly giving you more control on the turn and rate.

Note

- ✓ MS Series - Do not use a lubricant.
- ✓ 51R Series - Lubrication, using a SAE 20 weight lubricating oil, must be used for assembly.

D Transportation

3

Assembly



Place hex portion of socket into vise and tighten vise. Ensure socket extends past vise jaws enough to allow for installation of nipple.

Caution When tightening socket in vise, do not over tighten vise jaws. Over tightening vise jaws will distort internal threads of socket and hamper installation of nipple.

Using an SAE 20 weight lubricating oil, generously lubricate nipple and socket, threads and hose I.D.



Using using a wrench on the nipple hex, screw nipple into socket clockwise until nipple bottoms against socket shoulder.

Caution Nipple should be firm when tightened but not difficult to turn. If nipple is difficult to install, check hose for proper lubrication. Re-apply lubricating oil as necessary. Installation of nipple without proper lubrication will damage core tube.

Note - For 51R-series fittings, the nipple will thread directly into the hose and socket.

E Fittings

4

Measure and Inspect



Measure and verify hose assembly length.

F Tooling, Equipment, & Accessories

G General Technical

PTFE Assembly

Permanent Crimp - Series 91, 91N, 93N

CAUTION

There are several sections for Hose Assembly and Crimping. Be sure you are in the section that corresponds to the fitting series you are using. See Table of Contents for listing.

1

Cut

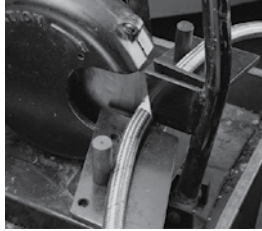

Using a power hose cut-off saw, cut hose squarely.



Fittings – Inspect nipple for a through-hole, damaged or missing threads and improperly crimped nut (if applicable). Do not use if these conditions exist. Inspect socket for damaged or missing threads. Do not use if conditions exist.

Note

✓ 93N Series -Make certain crimp shell is screwed tight to the nipple.

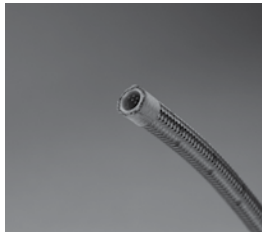

Visually inspect both ends of hose for square cut. Remove any burrs, loose fibers or wires.

2

Assembly

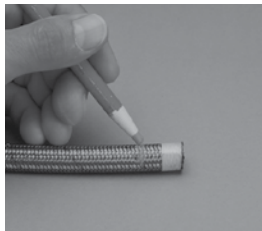

Insertion Depth – Mark hose end with proper insertion depth line. See Hose Fitting Insertion Values, E-10 for insertion depths of fitting series that do not incorporate an insertion depth. For jacketed PTFE hoses, use a sharp knife and light pressure to cut back the cover at least the length of the insertion depth of the fitting.



Assemble Hose – Push fitting onto hose slightly and then remove tape. Continue pushing fitting onto hose until fitting reaches depth insertion mark.

Warning Do not use lubricating oil when installing fittings on hose used in breathing air systems.

When installing fittings on hose used in breathing air systems, lubricate with a non-oil based soap solution as failure to do so may result in personal injury. personal injury when hose is used.

3

Die Selection

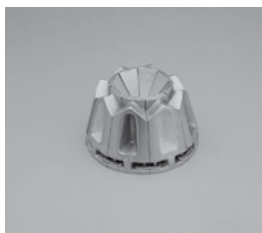

Select proper Parkrimp die set. Reference Crimp Die Selection at Crimpsource online. www.parker.com/crimpsource

4

Lubricate Bowl



Using a premium, quality, lithium-based grease. Apply a thin layer of grease on bowl of crimper base plate.

Hose
A

Tubing
Thermoplastic
B

Coiled Air Hose
& Fittings
C

Transportation
D

Fittings
E

Tooling, Equipment
& Accessories
F

General Technical
G

PTFE Assembly

Permanent Crimp - Series 91, 91N, 93N

CAUTION

There are several sections for Hose Assembly and Crimping. **Be sure you are in the section that corresponds to the fitting series you are using.** See Table of Contents for listing.

5

Die and Spacer Ring



Crimp Die – Place die set into bowl.

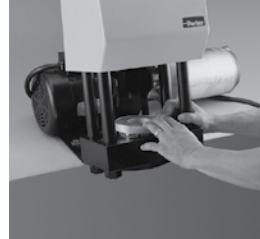

Die Ring – Place applicable die ring on top of crimp die. Position die ring so it is centered on the crimp die. Parflex utilizes the Silver die ring (8XC-R01) with limited exception.

Reference proper tooling (crimp die and die ring) at Crimpsource on-line.

www.parker.com/crimpsource

6

Crimp



Assemble Hose – Insert hose and fitting from bottom of crimper and up through die set. Position fitting so bottom of fitting skirt rests on die step (PARKALIGN® feature).

Warning Keep fingers and hands away from die-pusher area. Failure to do so may result in personal injury. Note - Pump on crimper must not exceed the rated pressure of the crimper being used. Parker Hannifin will not accept responsibility for the operation of or provide warranty coverage for a crimper that is operated by a power unit other than equipment supplied by Parker Hannifin for the express purpose of operating .

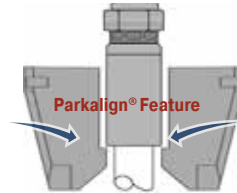

While holding hose and fitting in position on die step, crimp fitting onto hose until die ring contacts base plate.

Note - Pump on crimper must not exceed the rated pressure of the crimper being used. Parker Hannifin will not accept responsibility for the operation of or provide warranty coverage for a crimper that is operated by a power unit other than equipment supplied by Parker Hannifin for the express purpose of operating

Warning Keep fingers and hands away from die-pusher area. Failure to do so may result in personal injury.

7

Measure & Inspect



Measure and verify hose assembly length.

Inspect insertion depth mark at fitting ends. Insertion mark must be visible but not exceed 1/8" from end of crimped fitting shell.



Measure crimp diameter of each fitting at the top, middle and bottom of the crimp shell. Take measurements at a minimum of three (3) places around the shell circumference.

Crimp acceptance is based on the middle measurement average with a maximum taper of 0.010" between the top and bottom crimp averages. No single measurement outside the specification is permissible.

PTFE Assembly

Permanent Crimp - Series PAGE

CAUTION

There are several sections for Hose Assembly and Crimping. Be sure you are in the section that corresponds to the fitting series you are using. See Table of Contents for listing.

1

Inspection/Marking



Obtain correct hose, fittings and collars per customer order. Inspect to make certain no defects are present on fittings, collars or hose.

Using 1" wide filament tape, apply 1 to 1½ wraps of tape tightly around hose at location to be cut. Mark tape in the middle where cut will be made. Tape will be left on during crimping so only ½" width of tape should remain.



Fittings – Inspect each component for possible damage. In addition, inspect socket and nipple for a through-hole and threads.

2

Assembly

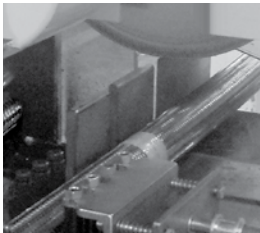

Cut hose.



Blow ends of hose off / out to remove any debris left from cutting operation. Cut off wires or fabric extending past the end of the hose.

3

Assembly



PAGE series fittings are not one piece but two pieces (insert plus collar) and must be properly installed to assure leak free long life assemblies.

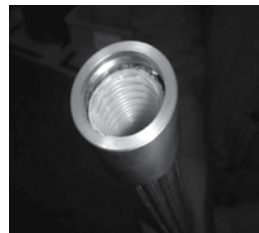

Orient and place collar on hose end fully.

Hose
A

Tubing
Thermoplastic
B

Coiled Air Hose
& Fittings
C

Transportation
D

Fittings
E

Tooling, Equipment
& Accessories
F

General Technical
G

PTFE Assembly

Permanent Crimp - Series PAGE

CAUTION

There are several sections for Hose Assembly and Crimping. Be sure you are in the section that corresponds to the fitting series you are using. See Table of Contents for listing.

A Hose

4

Assembly

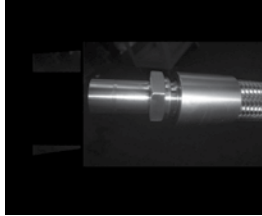

Using a taper punch, push punch into tube to enlarge bore of hose so insert just slides into hose.

Push insert into hose until lock groove of insert is just at end of collar.

Pull collar out towards end of insert until at correct crimp position on insert of collar.

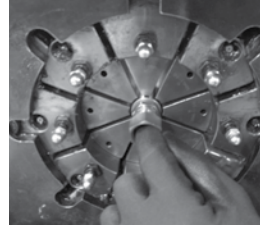

Pull collar out towards end of insert until at Crimp assembly only in Parker Approved adjustable crimper. Select correct die and crimp spec from Parker Crimp Source.

www.parker.com/crimpsource

a. Place assembly into crimp dies so full collar length crimp is obtained.

b. Check crimp dimensions in four places around the middle of the crimp circumference. Verify the average of those readings is within crimp specification tolerances.

Adjust crimper up or down if needed to obtain proper dimension.

c. Crimp opposite end following the same procedures.

Warning Keep fingers and hands away from die-pusher area. Failure to do so may result in personal injury.

B Tubing Thermoplastic

C Coiled Air Hose & Fittings

5

Inspect

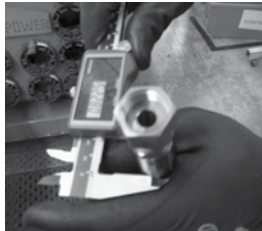

Inspect assembly, noting the length.

Test to correct test pressures to assure no leaks are observed using hydrostatic pressure unit (recommended).

Air or nitrogen under water can be used with caution utilizing the proper pressure and procedures for that equipment.

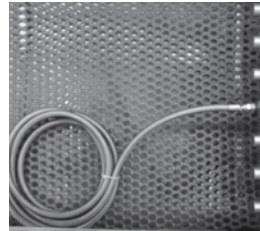

Blow out all water from the assembly and recheck length.

Note

- ✓ Note any movement of length and make compensations as needed on next assembly.
- ✓ Package assembly appropriately for customer requirements.

D Transportation

E Fittings

F Tooling, Equipment, & Accessories

G General Technical

PTFE Assembly

Field Attachable - Series 90

CAUTION

There are several sections for Hose Assembly and Crimping. Be sure you are in the section that corresponds to the fitting series you are using. See Table of Contents for listing.

1

Inspection



Hose – Visually inspect both ends of hose for square cut. Remove any burrs, loose fibers or wires.



Fittings – Inspect each component for possible damage.

Inspect socket and nipple for a through-hole and threads.

2

Assembly

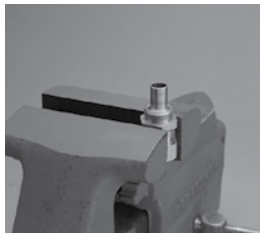

Mount nipple hex in vise. Ensure nipple end extends beyond vise jaws sufficiently to allow installation of hose.



Push hose bore onto nipple to size tube and to aid in separating braid before assembling ferrule onto hose.

Once completed, remove hose from nipple.

3

Assembly



By hand, push sleeve over end of PTFE core tube and under wire braid.



To complete positioning of sleeve, push hose end with sleeve against a solid flat surface.

Hose
A

Tubing
Thermoplastic
B

Coiled Air Hose
& Fittings
C

Transportation
D

Fittings
E

Tooling, Equipment
& Accessories
F

General Technical
G

PTFE Assembly

Field Attachable - Series 90

CAUTION

There are several sections for Hose Assembly and Crimping. Be sure you are in the section that corresponds to the fitting series you are using. See Table of Contents for listing.

A Hose

5

Assembly



Verify tube butts against inside shoulder of ferrule.

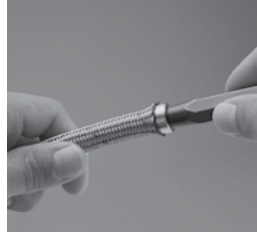

Using a tapered punch, push punch into end of sleeve and tube to set sleeve barbs into tube.

B Tubing Thermoplastic

6

Assembly



Using SAE 20 weight oil, lubricate nipple and socket threads. For stainless steel fittings use Parker ThreadMate® or a molybdenum type lubricant.



Assemble Hose – Using a twisting motion, push hose over nipple until hose is seated against nipple chamfer.

Warning Do not use lubricating oil when installing fittings on hose use in breathing air systems.

When installing fittings on hose used in breathing air systems, lubricate with a non-oil based soap solution as failure to do so may result in personal injury.

C Coiled Air Hose & Fittings

D Transportation

7

Assembly



Push socket forward and hand-start threading of socket to nipple.

Caution When tightening socket in vise, do not over tighten vise jaws. Over tightening vise jaws will distort internal threads of socket.

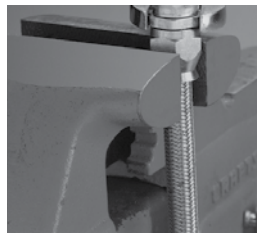

Remove assembly from vise and reposition with socket in vise jaws. Ensure socket extends beyond vise jaws far enough to allow nipple to be completely tightened.

E Fittings

8

Assembly



Wrench tighten nipple hex until clearance between hex and socket hex is 1/32" or less.

Tighten further to align corners of nipple and socket hexes if necessary.



Measure and verify hose assembly length.

F Tooling, Equipment, & Accessories

G General Technical

Sewer Hose Swaged Assembly

Series SQ

CAUTION

There are several sections for Hose Assembly and Crimping. Be sure you are in the section that corresponds to the fitting series you are using. See Table of Contents for listing.

1

Inspection

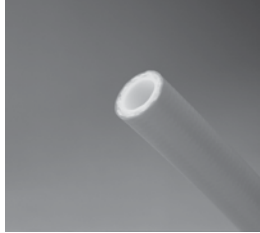

Hose - Visually inspect both ends of hose for square cut. Remove any burrs, loose fibers or wires.



Fittings - Visually inspect fitting for properly crimped shells, internal barbs, a through-hole and damage.

2

Assembly



Insertion Depth - Mark hose end with proper insertion depth line.



Lubricate - Using an SAE 20 weight oil, lightly lubricate inside of both hose ends.

3

Assembly



Assemble Hose - Push each hose end into fitting to the depth insertion mark.

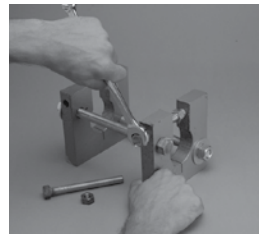

Remove both die securing bolts and nuts.

4

Assembly

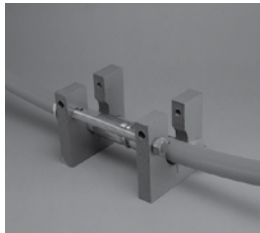

Place hose and fitting assembly into position on swager.

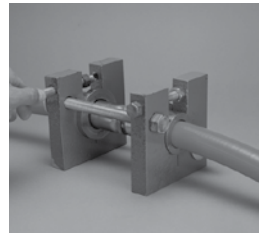

Insert both die halves around hose in each end of swager.
Install both die securing bolts with nuts positioned in opening of swager plates. Tighten die securing bolts 1/4 turn past finger tight.

Hose
A

Tubing
Thermoplastic
B

Coiled Air Hose
& Fittings
C

Transportation
D

Fittings
E

Tooling, Equipment
& Accessories
F

General Technical
G

Sewer Hose Swaged Assembly

Series SQ

CAUTION

There are several sections for Hose Assembly and Crimping. Be sure you are in the section that corresponds to the fitting series you are using. See Table of Contents for listing.

A Hose

5

Assembly

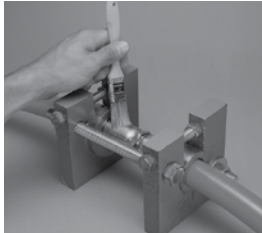

Lubricate – Using SAE 20 oil, generously lubricate the steel fitting surface and ID of the swage dies.

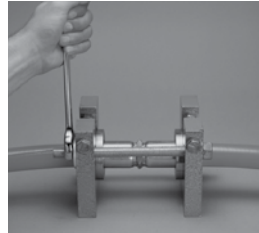

Assemble Hose – Align swager plates in parallel and tighten nuts on swaging bolts uniformly until dies touch.

Caution When tightening socket in vise, do not over tighten vise jaws. Over tightening vise jaws will distort internal threads of socket and hamper installation of nipple.

Generously lubricate swaging bolts. Failure to do so may result in an improperly swaged fitting.

B Tubing Thermoplastic

C Coiled Air Hose & Fittings

6

Assembly

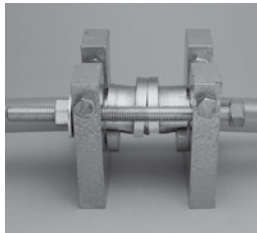

Loosen swaging bolts to release pressure on dies.

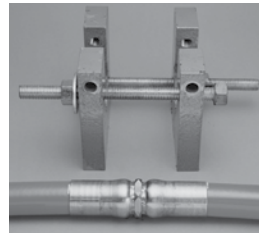

Remove die securing bolts and nuts. Then remove dies.

Push each hose end into fitting to the depth insertion mark.

D Transportation

7

Assembly

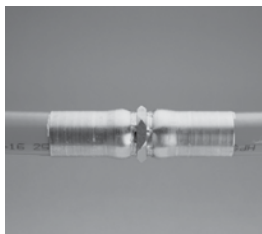

Measure and verify hose assembly length.

Inspect insertion depth mark at fitting ends, which must be visible, but not exceed 1/8" from end of swage shell.

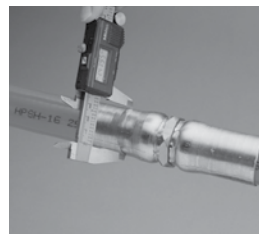

Measure swage diameter of each fitting at top, middle and bottom of shell. Take measurements at a minimum of three places around shell circumference. Verify swage diameter is within tolerances.

Reference Swage Specification & Tool Selection Chart on pg. F-14 for proper swage diameters.

E Fittings

F Tooling, Equipment, & Accessories

G General Technical

Twin/Multi-Line Separation

Factory-built assemblies are available using twin/multi-line hoses.

When field-built assemblies are preferred, the following steps must be taken.

1

Set-Up

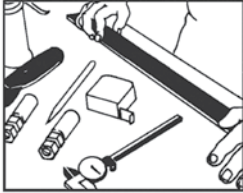

Position twinned or multi-line hose assembly so that it lies flat on work surface without tendency to twist or turn.

2

Measure

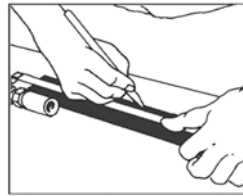

Measure hose to length.

Measure and mark the length that the hoses are to be separated (commonly referred to as Splitback Length).

3

Lubrication

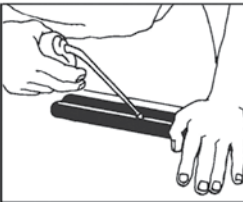

Lightly lubricate the web area between the hoses. Distribute the lubricant uniformly along the web of the assembly to be separated. Any lightweight oil will suffice (SAE 10 or 20). The function of the oil is to reduce the friction of the knife blade so that it naturally seeks the center of the valley formed by the hoses. This eliminates the need for the operator to steer the knife.

4

Cut

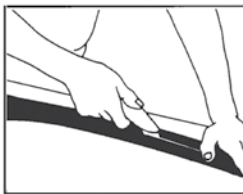

Press the multi-line hose assembly firmly and flat against the work surface with your free hand so that it does not move. Using a sharp utility knife, carefully draw the knife toward you with constant light to moderate pressure, and a smooth stroke. Multiple strokes will be necessary to separate the hoses.

Note - It is important that the knife blade be perpendicular to the hose during this procedure so that the blade cuts only the center line of the web. Extreme care must be taken to avoid cutting through the cover of the hoses and thereby exposing the hose reinforcement. If this occurs, the hose assembly must be discarded (See Figure 1). If the separation length is greater than that which can be accomplished with one continuous, smooth stroke, then the procedure should be repeated over shorter distances always cutting toward the free end of the hoses.

A Hose

B Tubing Thermoplastic

C Coiled Air Hose & Fittings

D Transportation

E Fittings

F Tooling, Equipment & Accessories

G General Technical

Twin/Multi-Line Separation

A Hose

5

Measure Separation

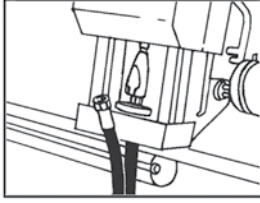

It is suggested that the separation length be sufficiently long so that the crimping operation can be accomplished without risk of kinking the hoses or tearing the web which could result in exposure of the hose reinforcement

B Tubing Thermoplastic

C Coiled Air Hose & Fittings

6

Apply Tape

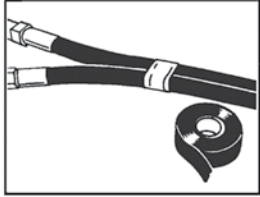

At the option of the assembler, as dictated by the installation, a nylon lashing strap or tape may be applied at the termination of the separated length to provide protection against tearing of the web or hose covers.

D Transportation

Incorrect Handling

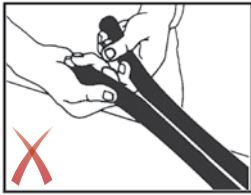

Extreme care must be taken to avoid cutting through the cover of the hoses and thereby exposing the hose reinforcement. If this occurs, the hose assembly must be discarded.

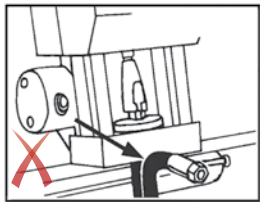

The separation length must allow for the crimping operation without damaging the hose.

F Tooling, Equipment, & Accessories

G General Technical

Parker Safety Guide

Parker Safety Guide for Selecting and Using Hose, Tubing, Fittings, Connectors, Conductors, Valves and Related Accessories



! Parker Safety Guide for Selecting and Using Hose, Tubing, Fittings and Related Accessories
Publication No. 4400-B.1 Revised: October 2015, Rev A

WARNING: Failure or improper selection or improper use of hose, tubing, fittings, assemblies, valves, connectors, conductors or related accessories ("Products") can cause death, personal injury and property damage. Possible consequences of failure or improper selection or improper use of these Products include but are not limited to:

- Fittings thrown off at high speed.
- High velocity fluid discharge.
- Explosion or burning of the conveyed fluid.
- Electrocution from high voltage electric powerlines.
- Contact with suddenly moving or falling objects that | are controlled by the conveyed fluid.
- Injections by high-pressure fluid discharge.
- Dangerously whipping Hose.

- Tube or pipe burst.
- Weld joint fracture.
- Contact with conveyed fluids that may be hot, cold, toxic or otherwise injurious.
- Sparking or explosion caused by static electricity buildup or other sources of electricity.
- Sparking or explosion while spraying paint or flammable liquids.
- Injuries resulting from inhalation, ingestion or exposure to fluids.

Before selecting or using any of these Products, it is important that you read and follow the instructions below. No product from any division in Parker Fluid Connectors Group is approved for in-flight aerospace applications. For hoses and fittings used in in-flight aerospace applications, please contact Parker Aerospace Group.

1.0 GENERAL INSTRUCTION

- 1.1 Scope: This safety guide provides instructions for selecting and using (including assembling, installing, and maintaining) these Products. For convenience, all rubber and/or thermoplastic products commonly called "hose" or "tubing" are called "Hose" in this safety guide. Metallic tube or pipe are called "tube". All assemblies made with Hose are called "Hose Assemblies". All assemblies made with Tube are called "Tube Assemblies". All products commonly called "fittings", "couplings" or "adapters" are called "Fittings". Valves are fluid system components that control the passage of fluid. Related accessories are ancillary devices that enhance or monitor performance including crimping, flaring, flanging, presetting, bending, cutting, deburring, swaging machines, sensors, tags, lockout handles, spring guards and associated tooling. This safety guide is a supplement to and is to be used with the specific Parker publications for the specific Hose, Fittings and Related Accessories that are being considered for use. Parker publications are available at www.parker.com. SAE J1273 (www.sae.org) and ISO 17165-2 (www.ansi.org) also provide recommended practices for hydraulic Hose Assemblies, and should be followed.
- 1.2 Fail-Safe: Hose, Hose Assemblies, Tube, Tube Assemblies and Fittings can and do fail without warning for many reasons. Design all systems and equipment in a fail-safe mode, so that failure of the Hose, Hose Assembly, Tube, Tube Assembly or Fitting will not endanger persons or property.
- 1.3 Distribution: Provide a copy of this safety guide to each person responsible for selecting or using Hose, Tube and Fitting products. Do not select or use Parker Hose, Tube or Fittings without thoroughly reading and understanding this safety guide as well as the specific Parker publications for the Products.
- 1.4 User Responsibility: Due to the wide variety of operating conditions and applications for Hose, Tube and Fittings. Parker does not represent or warrant that any particular Hose, Tube or Fitting is suitable for any specific end use system. This safety guide does not analyze all technical parameters that must be considered in selecting a product. The user, through its own analysis and testing, is solely responsible for:
- Making the final selection of the Products.
 - Assuring that the user's requirements are met and that the application presents no health or safety hazards.
 - Following the safety guide for Related Accessories and being trained to operate Related Accessories.
 - Providing all appropriate health and safety warnings on the equipment on which the Products are used.
 - Assuring compliance with all applicable government and industry standards.
- 1.5 Additional Questions: Call the appropriate Parker technical service department if you have any questions or require any additional information. See the Parker publication for the Products being considered or used, or call 1-800-CPARKER, or go to www.parker.com, for telephone numbers of the appropriate technical service department.

2.0 HOSE, TUBING & FITTING INSTRUCTION

- 2.1 The electrical conductivity or nonconductivity of Hose, Tube and Fittings is dependent upon many factors and may be susceptible to change. These factors include but are not limited to the various materials used to make the Hose and the Fittings, Fitting finish (some Fitting finishes are electrically conductive while others are nonconductive), manufacturing methods (including moisture control), how the Fittings contact the Hose, age and amount of deterioration or damage or other changes, moisture content of the Hose at any particular time, and other factors.
- The following are considerations for electrically nonconductive and conductive Hose. For other applications consult the individual catalog pages and the appropriate industry or regulatory standards for proper selection.
- 2.1.1 Electrically Nonconductive Hose: Certain applications require that the Hose be nonconductive to prevent electrical current flow or to maintain electrical isolation. For applications that require Hose to be electrically nonconductive, including, but not limited to, applications near high voltage electric lines, only special nonconductive Hose can be used. The manufacturer of the equipment in which the nonconductive Hose is to be used must be consulted to be certain that the Hose, Tube and Fittings that are selected are proper for the application. Do not use any Parker Hose or Fittings for any such application requiring nonconductive Hose, including but not limited to applications near high voltage electric lines or dense magnetic fields, unless (i) the application is expressly approved in the Parker technical publication for the product, (ii) the Hose is marked "nonconductive", and (iii) the manufacturer of the equipment on which the Hose is to be used specifically approves the particular Parker Hose, Tube and Fittings for such use.
- 2.1.2 Electrically Conductive Hose: Parker manufactures special Hose for certain applications that require electrically conductive Hose. Parker manufactures special Hose for conveying paint in airless paint spraying applications. This Hose is labeled "Electrically Conductive Airless Paint Spray Hose" on its layline and packaging. This Hose must be properly connected to the appropriate Parker Fittings and properly grounded in order to dissipate dangerous static charge buildup, which occurs in all airless paint spraying applications. Do not use any other Hose for airless paint spraying, even if electrically conductive. Use of any other Hose or failure to properly connect the Hose can cause a fire or an explosion resulting in death, personal injury, and property damage. All hoses that convey fuels must be grounded.
- Parker manufactures a special Hose for certain compressed natural gas ("CNG") applications where static electricity buildup may occur. Parker CNG Hose assemblies comply with the requirements of ANSI/IAS NGV 4.2; CSA 12.52, "Hoses for Natural Gas Vehicles and Dispensing Systems" (www.ansi.org). This Hose is labeled "Electrically Conductive for CNG Use" on its layline and packaging. This Hose must be properly connected to the appropriate Parker Fittings and properly grounded in order to dissipate dangerous static charge buildup, which occurs in, for example, high velocity CNG dispensing or transfer. Do not use any other Hose for CNG applications where static charge buildup may occur, even if electrically conductive. Use of other Hoses in CNG

Hose
A

Tubing
Thermoplastic
B

Coiled Air Hose
& Fittings
C

Transportation
D

Fittings
E

Tooling, Equipment
& Accessories
F

General Technical
G

Parker Safety Guide pg. 2

| | |
|---|-----------------------------------|
| A | Hose |
| B | Tubing Thermoplastic |
| C | Coiled Air Hose & Fittings |
| D | Transportation |
| E | Fittings |
| F | Tooling, Equipment, & Accessories |
| G | General Technical |

applications or failure to properly connect or ground this Hose can cause a fire or an explosion resulting in death, personal injury, and property damage. Care must also be taken to protect against CNG permeation through the Hose wall. See section 2.6, Permeation, for more information. Parker CNG Hose is intended for dispenser and vehicle use within the specified temperature range. Parker CNG Hose should not be used in confined spaces or unventilated areas or areas exceeding the specified temperature range.

Final assemblies must be tested for leaks. CNG Hose Assemblies should be tested on a monthly basis for conductivity per ANS I/ IAS NGV 4.2; CSA 12.52.

Parker manufactures special Hose for aerospace in-flight applications. Aerospace in-flight applications employing Hose to transmit fuel, lubricating fluids and hydraulic fluids require a special Hose with a conductive inner tube. This Hose for in-flight applications is available Only from Parker's Stratoflex Products Division. Do not use any other Parker Hose for in-flight applications, even if electrically conductive. Use of other Hoses for in-flight applications or failure to properly connect or ground this Hose can cause a fire or an explosion resulting in death, personal injury and property damage. These Hose assemblies for in-flight applications must meet all applicable aerospace industry, aircraft engine and aircraft requirements.

2.2 Pressure: Hose, Tube and Fitting selection must be made so that the published maximum working pressure of the Hose, Tube and Fittings are equal to or greater than the maximum system pressure. The maximum working pressure of a Hose, or Tube Assembly is the lower of the respective published maximum working pressures of the Hose, Tube and the Fittings used. Surge pressures or peak transient pressures in the system must be below the published maximum working pressure for the Hose, Tube and Fitting. Surge pressures and peak pressures can usually only be determined by sensitive electrical instrumentation that measures and indicates pressures at millisecond intervals. Mechanical pressure gauges indicate only average pressures and cannot be used to determine surge pressures or peak transient pressures. Published burst pressure ratings for Hose is for manufacturing test purposes only and is no indication that the Product can be used in applications at the burst pressure or otherwise above the published maximum recommended working pressure.

2.3 Suction: Hoses used for suction applications must be selected to insure that the Hose will withstand the vacuum and pressure of the system. Improperly selected Hose may collapse in suction application.

2.4 Temperature: Be certain that fluid and ambient temperatures, both steady and transient, do not exceed the limitations of the Hose, Tube, Fitting and Seals. Temperatures below and above the recommended limit can degrade Hose, Tube, Fittings and Seals to a point where a failure may occur and release fluid. Tube and Fittings performances are normally degraded at elevated temperature. Material compatibility can also change at temperatures outside of the rated range. Properly insulate and protect the Hose Assembly when routing near hot objects (e.g. manifolds). Do not use any Hose in any application where failure of the Hose could result in the conveyed fluids (or vapors or mist from the conveyed fluids) contacting any open flame, molten metal, or other potential fire ignition source that could cause burning or explosion of the conveyed fluids or vapors.

2.5 Fluid Compatibility: Hose and Tube Assembly selection must assure compatibility of the Hose tube, cover, reinforcement, Tube, Plating and Seals with the fluid media used. See the fluid compatibility chart in the Parker publication for the product being considered or used. This information is offered only as a guide. Actual service life can only be determined by the end user by testing under all extreme conditions and other analysis.

Hose, and Tube that is chemically compatible with a particular fluid must be assembled using Fittings and adapters containing likewise compatible seals. Flange or flare processes can change Tube material properties that may not be compatible with certain requirements such as NACE.

2.6 Permeation: Permeation (that is, seepage through the Hose or Seal) will occur from inside the Hose or Fitting to outside when Hose or Fitting is used with gases, liquid and gas fuels, and refrigerants (including but not limited to such materials as helium, diesel fuel, gasoline, natural gas, or LPG). This permeation may result in high concentrations of vapors which are potentially flammable, explosive, or toxic, and in loss of fluid. Dangerous explosions, fires, and other hazards can result when using the wrong Hose for such applications. The system designer must take into account the fact that this permeation will take place and must not use Hose or Fitting if this permeation could be hazardous. The system designer must take into account all legal, government, insurance, or any other special regulations which govern the use of fuels and refrigerants. Never use a Hose or Fitting even though the fluid compatibility is acceptable without considering the potential hazardous effects that can result from permeation through the Hose or Tube Assembly. Permeation of moisture from outside the Hose or Fitting to inside the Hose or Fitting will also occur in Hose or Tube assemblies, regardless of internal pressure. If this moisture permeation would have detrimental effects (particularly, but not

limited to refrigeration and air conditioning systems), incorporation of sufficient drying capacity in the system or other appropriate system safeguards should be selected and used. The sudden pressure release of highly pressurized gas could also result in Explosive Decompression failure of permeated Seals and Hoses.

2.7 Size: Transmission of power by means of pressurized fluid varies with pressure and rate of flow. The size of the components must be adequate to keep pressure losses to a minimum and avoid damage due to heat generation or excessive fluid velocity.

2.8 Routing: Attention must be given to optimum routing to minimize inherent problems (kinking or flow restriction due to Hose collapse, twisting of the Hose, proximity to hot objects or heat sources). For additional routing recommendations see SAE J1273 and ISO 17165-2. Hose Assemblies have a finite life and should be installed in a manner that allows for ease of inspection and future replacement. Hose because of its relative short life, should not be used in residential and commercial buildings inside of inaccessible walls or floors, unless specifically allowed in the product literature. Always review all product literature for proper installation and routing instructions.

2.9 Environment: Care must be taken to insure that the Hose, Tube and Fittings are either compatible with or protected from the environment (that is, surrounding conditions) to which they are exposed. Environmental conditions including but not limited to ultraviolet radiation, sunlight, heat, ozone, moisture, water, salt water, chemicals and air pollutants can cause degradation and premature failure.

2.10 Mechanical Loads: External forces can significantly reduce Hose, Tube and Fitting life or cause failure. Mechanical loads which must be considered include excessive flexing, twist, kinking, tensile or side loads, bend radius, and vibration. Use of swivel type Fittings or adapters may be required to insure no twist is put into the Hose. Use of proper Hose or Tube clamps may also be required to reduce external mechanical loads. Unusual applications may require special testing prior to Hose selection.

2.11 Physical Damage: Care must be taken to protect Hose from wear, snagging, kinking, bending smaller than minimum bend radius and cutting, any of which can cause premature Hose failure. Any Hose that has been kinked or bent to a radius smaller than the minimum bend radius, and any Hose that has been cut or is cracked or is otherwise damaged should be removed and discarded. Fittings with damages such as scratches on sealing surfaces and deformation should be replaced.

2.12 Proper End Fitting: See instructions 3.2 through 3.5. These recommendations may be substantiated by testing to industry standards such as SAE J517 for hydraulic applications, or MIL-A-5070, AS1339, or AS3517 for Hoses from Parker's Stratoflex Products Division for aerospace applications.

2.13 Length: When determining the proper Hose or Tube length of an assembly, be aware of Hose length change due to pressure, Tube length change due to thermal expansion or contraction, and Hose or Tube and machine tolerances and movement must be considered. When routing short hose assemblies, it is recommended that the minimum free hose length is always used. Consult the hose manufacturer for their minimum free hose length recommendations. Hose assemblies should be installed in such a way that any motion or flexing occurs within the same plane.

2.14 Specifications and Standards: When selecting Hose, Tube and Fittings, government, industry, and Parker specifications and recommendations must be reviewed and followed as applicable.

2.15 Hose Cleanliness: Hose and Tube components may vary in cleanliness levels. Care must be taken to insure that the Hose and Tube Assembly selected has an adequate level of cleanliness for the application.

2.16 Fire Resistant Fluids: Some fire resistant fluids that are to be conveyed by Hose or Tube require use of the same type of Hose or Tube as used with petroleum base fluids. Some such fluids require a special Hose, Tube, Fitting and Seal, while a few fluids will not work with any Hose at all. See instructions 2.5 and 1.5. The wrong Hose, Tube, Fitting or Seal may fail after a very short service. In addition, all liquids but pure water may burn fiercely under certain conditions, and even pure water leakage may be hazardous.

2.17 Radiant Heat: Hose and Seals can be heated to destruction without contact by such nearby items as hot manifolds or molten metal. The same heat source may then initiate a fire. This can occur despite the presence of cool air around the Hose or Seal. Performance of Tube and Fitting subjected to the heat could be degraded.

2.18 Welding or Brazing: When using a torch or arc welder in close proximity to hydraulic lines, the hydraulic lines should be removed or shielded with appropriate fire resistant materials. Flame or weld spatter could burn through the Hose or Seal and possibly ignite escaping fluid resulting in a catastrophic failure. Heating of plated parts, including Hose Fittings and adapters, above 450°F (232°C) such as during welding, brazing or soldering may emit deadly gases. Any elastomer seal on fittings shall be removed prior to welding or brazing, any metallic surfaces shall be protected after brazing or welding when necessary. Welding and brazing

- filler material shall be compatible with the Tube and Fitting that are joined.
- 2.19 Atomic Radiation: Atomic radiation affects all materials used in Hose and Tube assemblies. Since the long-term effects may be unknown, do not expose Hose or Tube assemblies to atomic radiation. Nuclear applications may require special Tube and department.
 - 2.20 Aerospace Applications: The only Hose, Tube and Fittings that may be used for in-flight aerospace applications are those available from Parker's Stratoflex Products Division. Do not use any other Hose or Fittings for in-flight applications. Do not use any Hose or Fittings from Parker's Stratoflex Products Division with any other Hose or Fittings, unless expressly approved in writing by the engineering manager or chief engineer of Stratoflex Products Division and verified by the user's own testing and inspection to aerospace industry standards.
 - 2.21 Unlocking Couplings: Ball locking couplings or other Fittings with quick disconnect ability can unintentionally disconnect if they are dragged over obstructions, or if the sleeve or other disconnect member, is bumped or moved enough to cause disconnect. Threaded Fittings should be considered where there is a potential for accidental uncoupling.

3.0 HOSE AND FITTINGS ASSEMBLY AND INSTALLATION INSTRUCTIONS

- 3.1 Component Inspection: Prior to assembly, a careful examination of the Hose and Fittings must be performed. All components must be checked for correct style, size, catalog number, and length. The Hose must be examined for cleanliness, obstructions, blisters, cover looseness, kinks, cracks, cuts or any other visible defects. Inspect the Fitting and sealing surfaces for burrs, nicks, corrosion or other imperfections. Do NOT use any component that displays any signs of nonconformance.
- 3.2 Hose and Fitting Assembly: Do not assemble a Parker Fitting on a Parker Hose that is not specifically listed by Parker for that Fitting, unless authorized in writing by the engineering manager or chief engineer of the appropriate Parker division. Do not assemble a Parker Fitting on another manufacturer's Hose or a Parker Hose on another manufacturer's Fitting unless (i) the engineering manager or chief engineer of the appropriate Parker division approves the Assembly in writing or that combination is expressly approved in the appropriate Parker literature for the specific Parker product, and (ii) the user verifies the Assembly and the application through analysis and testing. For Parker Hose that does not specify a Parker Fitting, the user is solely responsible for the selection of the proper Fitting and Hose Assembly procedures. See instruction 1.4. To prevent the possibility of problems such as leakage at the Fitting or system contamination, it is important to completely remove all debris from the cutting operation before installation of the Fittings. The Parker published instructions must be followed for assembling the Fittings on the Hose. These instructions are provided in the Parker Fitting catalog for the specific Parker Fitting being used, or by calling 1-800-CPARKER, or at www.parker.com.
- 3.3 Related Accessories: Do not crimp or swage any Parker Hose or Fitting with anything but the listed swage or crimp machine and dies in accordance with Parker published instructions. Do not crimp or swage another manufacturer's Fitting with a Parker crimp or swage die unless authorized in writing by the engineering manager or chief engineer of the appropriate Parker division.
- 3.4 Parts: Do not use any Parker Fitting part (including but not limited to socket, shell, nipple, or insert) except with the correct Parker mating parts, in accordance with Parker published instructions, unless authorized in writing by the engineering manager or chief engineer of the appropriate Parker division.
- 3.5 Field Attachable/Permanent: Do not reuse any field attachable Hose Fitting that has blown or pulled off a Hose. Do not reuse a Parker Permanent Hose Fitting (crimped or swaged) or any part thereof. Complete Hose Assemblies may only be reused after proper inspection under section 4.0. Do not assemble Fittings to any previously used hydraulic Hose that was in service, for use in a fluid power application.
- 3.6 Pre-Installation Inspection: Prior to installation, a careful examination of the Hose Assembly must be performed. Inspect the Hose Assembly for any damage or defects. DO NOT use any Hose Assembly that displays any signs of nonconformance.
- 3.7 Minimum Bend Radius: Installation of a Hose at less than the minimum listed bend radius may significantly reduce the Hose life. Particular attention must be given to preclude sharp bending at the Hose to Fitting juncture. Any bending during installation at less than the minimum bend radius must be avoided. If any Hose is kinked during installation, the Hose must be discarded.
- 3.8 Twist Angle and Orientation: Hose Assembly installation must be such that relative motion of machine components does not produce twisting.
- 3.9 Securement: In many applications, it may be necessary to restrain, protect, or guide the Hose to protect it from damage by unnecessary flexing, pressure surges, and contact with other mechanical components.

- 3.10 Proper Connection of Ports: Proper physical installation of the Hose Assembly requires a correctly installed port connection insuring that no twist or torque is transferred to the Hose when the Fittings are being tightened or otherwise during use.
- 3.11 External Damage: Proper installation is not complete without insuring that tensile loads, side loads, kinking, flattening, potential abrasion, thread damage or damage to sealing surfaces are corrected or eliminated. See instruction 2.10.
- 3.12 System Checkout: All air entrapment must be eliminated and the system pressurized to the maximum system pressure (at or below the Hose maximum working pressure) and checked for proper function and freedom from leaks. Personnel must stay out of potential hazardous areas while testing and using.
- 3.13 Routing: The Hose Assembly should be routed in such a manner so if a failure does occur, the escaping media will not cause personal injury or property damage. In addition, if fluid media comes in contact with hot surfaces, open flame or sparks, a fire or explosion may occur. See section 2.4.
- 3.14 Ground Fault Equipment Protection Devices (GFEEDs): WARNING! Fire and Shock Hazard. To minimize the danger of fire if the heating cable of a Multitube bundle is damaged or improperly installed, use a Ground Fault Equipment Protection Device. Electrical fault currents may be insufficient to trip a conventional circuit breaker. For ground fault protection, the IEEE 515: (www.ansi.org) standard for heating cables recommends the use of GFEEDs with a nominal 30 milliamper trip level for "piping systems in classified areas, those areas requiring a high degree of maintenance, or which may be exposed to physical abuse or corrosive atmospheres".

4.0 TUBE AND FITTINGS ASSEMBLY AND INSTALLATION INSTRUCTIONS

- 4.1 Component Inspection: Prior to assembly, a careful examination of the Tube and Fittings must be performed. All components must be checked for correct style, size, material, seal, and length. Inspect the Fitting and sealing surfaces for burrs, nicks, corrosion, missing seal or other imperfections. Do NOT use any component that displays any signs of nonconformance.
- 4.2 Tube and Fitting Assembly: Do not assemble a Parker Fitting with a Tube that is not specifically listed by Parker for that Fitting, unless authorized in writing by the engineering manager or chief engineer of the appropriate Parker division. The Tube must meet the requirements specified to the Fitting. The Parker published instructions must be followed for assembling the Fittings to a Tube. These instructions are provided in the Parker Fitting catalog for the specific Parker Fitting being used, or by calling 1-800-CPARKER, or at www.parker.com.
- 4.3 Related Accessories: Do not preset or flange Parker Fitting components using another manufacturer's equipment or procedures unless authorized in writing by the engineering manager or chief engineer of the appropriate Parker division. Tube, Fitting component and tooling must be checked for correct style, size and material. Operation and maintenance of Related Accessories must be in accordance with the operation manual for the designated Accessory.
- 4.4 Securement: In many applications, it may be necessary to restrain, protect, or guide the Tube to protect it from damage by unnecessary flexing, pressure surges, vibration, and contact with other mechanical components. Care must be taken to insure such restraints do not introduce additional stress or wear points.
- 4.5 Proper Connection of Ports: Proper physical installation of the Tube Assembly requires a correctly installed port connection insuring that no torque is transferred to the Tube when the Fittings are being tightened or otherwise during use.
- 4.6 External Damage: Proper installation is not complete without insuring that tensile loads, side loads, flattening, potential abrasion, thread damage or damage to sealing surfaces are corrected or eliminated. See instruction 2.10.
- 4.7 System Checkout: All air entrapment must be eliminated and the system pressurized to the maximum system pressure (at or below the Tube Assembly maximum working pressure) and checked for proper function and freedom from leaks. Personnel must stay out of potential hazardous areas while testing and using.
- 4.8 Routing: The Tube Assembly should be routed in such a manner so if a failure does occur, the escaping media will not cause personal injury or property damage. In addition, if fluid media comes in contact with hot surfaces, open flame or sparks, a fire or explosion may occur. See section 2.4.

A Hose

B Tubing Thermoplastic

C Coiled Air Hose & Fittings

D Transportation

E Fittings

F Tooling, Equipment & Accessories

G General Technical

| | |
|---|--------------------------------------|
| A | Hose |
| B | Tubing Thermoplastic |
| C | Coiled Air Hose & Fittings |
| D | Transportation |
| E | Fittings |
| F | Tooling, Equipment, & Accessories |
| G | General Technical |

5.0 HOSE AND FITTING MAINTENANCE AND REPLACEMENT INSTRUCTIONS

5.1 Proper Selection: Even with proper selection and installation, Hose life may be significantly reduced without a continuing maintenance program. The severity of the application, risk potential from a possible Hose failure, and experience with any Hose failures in the application or in similar applications should determine the frequency of the inspection and the replacement for the Products so that Products are replaced before any failure occurs. Certain products require maintenance and inspection per industry requirements. Failure to adhere to these requirements may lead to premature failure. A maintenance program must be established and followed by the user and, at minimum, must include instructions 5.2 through 5.7.

5.2 Visual Inspection Hose/Fitting: Any of the following conditions require immediate shut down and replacement of the Hose Assembly:

- Fitting slippage on Hose;
- Damaged, cracked, cut or abraded cover (any reinforcement exposed);
- Hard, stiff, heat cracked, or charred Hose;
- Cracked, damaged, or badly corroded Fittings;
- Leaks at Fitting or in Hose;
- Kinked, crushed, flattened or twisted Hose; and
- Blistered, soft, degraded, or loose cover.

5.3 Visual Inspection All Other: The following items must be tightened, repaired, corrected or replaced as required:

- Leaking port conditions;
- Excess dirt buildup;
- Worn clamps, guards or shields; and
- System fluid level, fluid type, and any air entrapment.

5.4 Functional Test: Operate the system at maximum operating pressure and check for possible malfunctions and leaks. Personnel must avoid potential hazardous areas while testing and using the system. See section 2.2.

5.5 Replacement Intervals: Hose assemblies and elastomeric seals used on Hose Fittings and adapters will eventually age, harden, wear and deteriorate under thermal cycling and compression set. Hose Assemblies and elastomeric seals should be inspected and replaced at specific replacement intervals, based on previous service life, government or industry recommendations, or when failures could result in unacceptable down time, damage, or injury risk. See section 1.2. Hose and Fittings may be subjected to internal mechanical and/or chemical wear from the conveying fluid and may fail without warning. The user must determine the product life under such circumstances by testing. Also see section 2.5.

5.6 Hose Inspection and Failure: Hydraulic power is accomplished by utilizing high pressure fluids to transfer energy and do work. Hoses, Fittings and Hose Assemblies all contribute to this by transmitting fluids at high pressures. Fluids under pressure can be dangerous and potentially lethal and, therefore, extreme caution must be exercised when working with fluids under pressure and handling the Hoses transporting the fluids.

From time to time, Hose Assemblies will fail if they are not replaced at proper time intervals. Usually these failures are the result of some form of misapplication, abuse, wear or failure to perform proper maintenance. When Hoses fail, generally the high pressure fluids inside escape in a stream which may or may not be visible to the user. Under no circumstances should the user attempt to locate the leak by "feeling" with their hands or any other part of their body. High pressure fluids can and will penetrate the skin and cause severe tissue damage and possibly loss of limb. Even seemingly minor hydraulic fluid injection injuries must be treated immediately by a physician with knowledge of the tissue damaging properties of hydraulic fluid.

If a Hose failure occurs, immediately shut down the equipment and leave the area until pressure has been completely released from the Hose Assembly. Simply shutting down the hydraulic pump may or may not eliminate the pressure in the Hose Assembly. Many times check valves, etc., are employed in a system and can cause pressure to remain in a Hose Assembly even when pumps or equipment are not operating. Tiny holes in the Hose, commonly known as pinholes, can eject small, dangerously powerful but hard to see streams of hydraulic fluid. It may take several minutes or even hours for the pressure to be relieved so that the Hose Assembly may be examined safely.

Once the pressure has been reduced to zero, the Hose Assembly may be taken off the equipment and examined. It must always be replaced if a failure has occurred. Never attempt to patch or repair a Hose Assembly that has failed. Consult the nearest Parker distributor or the appropriate Parker division for Hose Assembly replacement information.

Never touch or examine a failed Hose Assembly unless it is obvious that the Hose no longer contains fluid under pressure. The high pressure fluid is extremely dangerous and can cause serious and potentially fatal injury.

5.7 Elastomeric seals: Elastomeric seals will eventually age, harden, wear and deteriorate under thermal cycling and compression set. Elastomeric seals should be inspected and replaced.

5.8 Refrigerant gases: Special care should be taken when working with refrigeration systems. Sudden escape of refrigerant gases can cause blindness if the escaping gases contact the eye and can cause freezing or other severe injuries if it contacts any other portion of the body.

5.9 Compressed natural gas (CNG): Parker CNG Hose Assemblies should be tested after installation and before use, and at least on a monthly basis per instructions provided on the Hose Assembly tag. The recommended procedure is to pressurize the Hose and check for leaks and to visually inspect the Hose for damage and to perform an electrical resistance test. Caution: Matches, candles, open flame or other sources of ignition shall not be used for Hose inspection. Leak check solutions should be rinsed off after use.

6.0 HOSE STORAGE

6.1 Age Control: Hose and Hose Assemblies must be stored in a manner that facilitates age control and first-in and first-out usage based on manufacturing date of the Hose and Hose Assemblies. Unless otherwise specified by the manufacturer or defined by local laws and regulations:

6.1.1 The shelf life of rubber hose in bulk form or hose made from two or more materials is 28 quarters (7 years) from the date of manufacture, with an extension of 12 quarters (3 years), if stored in accordance with ISO 2230;

6.1.2 The shelf life of thermoplastic and polytetrafluoroethylene hose is considered to be unlimited;

6.1.3 Hose assemblies that pass visual inspection and proof test shall not be stored for longer than 2 years;

6.1.4 Storage: Stored Hose and Hose Assemblies must not be subjected to damage that could reduce their expected service life and must be placed in a cool, dark and dry area with the ends capped. Stored Hose and Hose Assemblies must not be exposed to temperature extremes, ozone, oils, corrosive liquids or fumes, solvents, high humidity, rodents, insects, ultraviolet light, electromagnetic fields or radioactive materials.

ENERPAC Warranty Policy

For those ENERPAC items sold as part of the Parker Parflex Division product offering, the following warranty applies.

ENERPAC products are warranted to be free of defects in materials and workmanship under normal use for as long as they are owned by the original purchaser, subject to the exclusions and limitations described below. This warranty does not cover ordinary wear and tear, overloading, alterations, (including repairs or attempted repairs by parties other than ENERPAC or its authorized service representatives), improper fluid, use in a manner for which they are not intended or use which is contrary to instructions for the products.

THIS WARRANTY IS LIMITED TO NEW PRODUCTS SOLD THROUGH ENERPAC AUTHORIZED DISTRIBUTORS, ORIGINAL EQUIPMENT MANUFACTURERS OR OTHER DESIGNATED CHANNELS OF DISTRIBUTION. NO AGENT, EMPLOYEE, OR OTHER REPRESENTATIVE OF ENERPAC HAS THE AUTHORITY TO IN ANY WAY CHANGE OR AMEND THIS WARRANTY.

Electronic products and components are warranted against defects in material and workmanship for a period of two years from the date of purchase.

The following items supplied with ENERPAC products are excluded from this warranty:

Components not manufactured by ENERPAC, including air motors, electric motors, gasoline engines, and diesel engines. Such items are warranted to the extent of the warranty provided by the manufacturers of such items.

If the customer believes a product is defective, the product must be delivered, or shipped freight prepaid, to the nearest ENERPAC Authorized Service Center. The customer should contact ENERPAC to locate and Authorized Service Center in the customer's area.

Products that do not conform to this warranty will be returned by ground transportation, freight prepaid.

THE FOREGOING WARRANT IS EXCLUSIVE AND IS IN LIEU OF ALL OTHER EXPRESS AND IMPLIED WARRANTIES, INCLUDING BUT NOT LIMITED TO THE IMPLIED WARRANTIES OF MERCHANTABILITY AND FITNESS FOR A PARTICULAR PURPOSE.

The remedy of repair, replacement or refund is customer's exclusive remedy in the event of breach of this warranty.

SELLER SHALL NOT BE SUBJECT TO AND DISCLAIM:

- (a) ANY OTHER OBLIGATIONS OR LIABILITIES ARISING OUT OF BREACH OF CONTRACT OR OF WARRANTY,
- (b) ANY OBLIGATIONS WHATSOEVER ARISING FROM TORT CLAIMS (INCLUDING NEGLIGENCE AND STRICT LIABILITY) OR ARISING UNDER THEORIES OR LAW WITH RESPECT TO PRODUCTS SOLD OR SERVICES RENDERED BY SELLER OR ANY UNDERTAKINGS, ACTS OR OMISSIONS RELATING THERETO, AND
- (c) ALL CONSEQUENTIAL, INCIDENTAL AND CONTINGENT DAMAGES WHATSOEVER.

ENERPAC's liability in all cases is limited to, and shall not exceed, the purchase price paid.

For the nearest authorized ENERPAC SERVICE CENTER, please call ENERPAC at 1-800-558-0530 or visit the ENERPAC web site at www.Enerpac.com.

A Hose

B Tubing Thermoplastic

C Coiled Air Hose & Fittings

D Transportation

E Fittings

F Tooling, Equipment & Accessories

G General Technical

Offer of Sale

PARKER-HANNIFIN CORPORATION OFFER OF SALE

Definitions. As used herein, the following terms have the meanings indicated.

- Buyer: means any customer receiving a Quote for Products from Seller.
- Goods: means any tangible part, system or component to be supplied by the Seller.
- Products: means the Goods, Services and/or Software as described in a Quote provided by the Seller.
- Quote: means the offer or proposal made by Seller to Buyer for the supply of Products.
- Seller: means Parker-Hannifin Corporation, including all divisions and businesses thereof.
- Services: means any services to be supplied by the Seller.
- Software: means any software related to the Products, whether embedded or separately downloaded.
- Terms: means the terms and conditions of this Offer of Sale or any newer version of the same as published by Seller electronically at www.parker.com/saleterms.

1. **Terms.** All sales of Products by Seller are contingent upon, and will be governed by, these Terms and, these Terms are incorporated into any Quote provided by Seller to any Buyer. Buyer's order for any Products whether communicated to Seller verbally, in writing, by electronic data interface or other electronic commerce, shall constitute acceptance of these Terms. Seller objects to any contrary or additional terms or conditions of Buyer. Reference in Seller's order acknowledgement to Buyer's purchase order or purchase order number shall in no way constitute an acceptance of any of Buyer's terms of purchase. No modification to these Terms will be binding on Seller unless agreed to in writing and signed by an authorized representative of Seller.

2. **Price; Payment.** The Products set forth in Seller's Quote are offered for sale at the prices indicated in Seller's Quote. Unless otherwise specifically stated in Seller's Quote, prices are valid for thirty (30) days and do not include any sales, use, or other taxes or duties. Seller reserves the right to modify prices at any time to adjust for any raw material price fluctuations. Unless otherwise specified by Seller, all prices are F.C.A. Seller's facility (INCOTERMS 2010). All sales are contingent upon credit approval and payment for all purchases is due thirty (30) days from the date of invoice (or such date as may be specified in the Quote). Unpaid invoices beyond the specified payment date incur interest at the rate of 1.5% per month or the maximum allowable rate under applicable law.

3. **Shipment; Delivery; Title and Risk of Loss.** All delivery dates are approximate. Seller is not responsible for damages resulting from any delay. Regardless of the manner of shipment, delivery occurs and title and risk of loss or damage pass to Buyer, upon placement of the Products with the shipment carrier at Seller's facility. Unless otherwise agreed, Seller may exercise its judgment in choosing the carrier and means of delivery. No deferral of shipment at Buyer's request beyond the respective indicated shipping date will be made except on terms that will indemnify, defend and hold Seller harmless against all loss and additional expense. Buyer shall be responsible for any additional shipping charges incurred by Seller due to Buyer's acts or omissions.

4. **Warranty.** The warranty related to the Products is as follows: (i) Goods are warranted against defects in material or workmanship for a period of twelve (12) months from the date of delivery or 2,000 hours of use, whichever occurs first; (ii) Services shall be performed in accordance with generally accepted practices and using the degree of care and skill that is ordinarily exercised and customary in the field to which the Services pertain and are warranted for a period of six (6) months from the completion of the Services by Seller; and (iii) Software is only warranted to perform in accordance with applicable specifications provided by Seller to Buyer for ninety (90) days from the date of delivery or, when downloaded by a Buyer or end-user, from the date of the initial download. All prices are based upon the exclusive limited warranty stated above, and upon the following disclaimer:

DISCLAIMER OF WARRANTY: THIS WARRANTY IS THE SOLE AND ENTIRE WARRANTY PERTAINING TO PRODUCTS. SELLER DISCLAIMS ALL OTHER WARRANTIES, EXPRESS AND IMPLIED, INCLUDING DESIGN, NONINFRINGEMENT, MERCHANTABILITY, AND FITNESS FOR A PARTICULAR PURPOSE. SELLER DOES NOT WARRANT THAT THE SOFTWARE IS ERROR-FREE OR FAULT-TOLERANT, OR THAT BUYER'S USE THEREOF WILL BE SECURE OR UNINTERRUPTED. BUYER AGREES AND ACKNOWLEDGES THAT UNLESS OTHERWISE AUTHORIZED IN WRITING BY SELLER THE SOFTWARE SHALL NOT BE USED IN CONNECTION WITH HAZARDOUS OR HIGH RISK ACTIVITIES OR ENVIRONMENTS. EXCEPT AS EXPRESSLY STATED HEREIN, ALL PRODUCTS ARE PROVIDED "AS IS".

5. **Claims; Commencement of Actions.** Buyer shall promptly inspect all Products upon receipt. No claims for shortages will be allowed unless reported to the Seller within ten (10) days of delivery. Buyer shall notify Seller of any alleged breach of warranty within thirty (30) days after the date the non-conformance is or should have been discovered by Buyer. Any claim or action against Seller based upon breach of contract or any other theory, including tort, negligence, or otherwise must be commenced within twelve (12) months from the date of the alleged breach or other alleged event, without regard to the date of discovery.

6. **LIMITATION OF LIABILITY.** IN THE EVENT OF A BREACH OF WARRANTY, SELLER WILL, AT ITS OPTION, REPAIR OR REPLACE THE NON-CONFORMING PRODUCT, RE-PERFORM THE SERVICES, OR REFUND THE PURCHASE PRICE PAID WITHIN A REASONABLE PERIOD OF TIME. **IN NO EVENT IS SELLER LIABLE FOR ANY SPECIAL, INDIRECT, INCIDENTAL OR CONSEQUENTIAL DAMAGES ARISING OUT OF, OR AS THE RESULT OF, THE SALE, DELIVERY, NON- DELIVERY, SERVICING, NON-COMPLETION OF SERVICES, USE, LOSS OF USE OF, OR INABILITY TO USE THE PRODUCTS OR ANY PART THEREOF, LOSS OF DATA, IDENTITY, PRIVACY, OR CONFIDENTIALITY, OR FOR ANY CHARGES OR EXPENSES OF ANY NATURE INCURRED WITHOUT SELLER'S WRITTEN CONSENT, WHETHER BASED IN CONTRACT, TORT OR OTHER LEGAL THEORY. IN NO EVENT SHALL SELLER'S LIABILITY UNDER ANY CLAIM MADE BY BUYER EXCEED THE PURCHASE PRICE PAID FOR THE PRODUCTS.**

7. **Loss to Buyer's Property.** Any designs, tools, patterns, materials, drawings, confidential information or equipment furnished by Buyer or any other items which are or become Buyer's property, will be considered obsolete and may be destroyed by Seller after two (2) consecutive years have elapsed without Buyer ordering the Products manufactured using such property. Seller shall not be responsible for any loss or damage to such property while it is in Seller's possession or control.

Special Tooling. Special Tooling includes but is not limited to tooling, jigs, fixtures and associated manufacturing equipment acquired or necessary to manufacture Products. A tooling charge may be imposed for any Special Tooling. Such Special Tooling shall be and remain Seller's property notwithstanding payment of any charges by Buyer. In no event will Buyer acquire any interest in Special Tooling belonging to Seller that is utilized in the manufacture of the Products, even if such Special Tooling has been specially converted or adapted for such manufacture and notwithstanding any charges paid by Buyer. Unless otherwise agreed, Seller has the right to alter, discard or otherwise dispose of any Special Tooling or other property in its sole discretion at any time.

Security Interest. To secure payment of all sums due, Seller retains a security interest in all Products delivered to Buyer and, Buyer's acceptance of these Terms is deemed to be a Security Agreement under the Uniform Commercial Code. Buyer authorizes Seller as its attorney to execute and file on Buyer's behalf all documents Seller deems necessary to perfect its security interest.

8. **User Responsibility.** The Buyer through its own analysis and testing, is solely responsible for making the final selection of the Products and assuring that all performance, endurance, maintenance, safety and warning requirements of the application of the Products are met. The Buyer must analyze all aspects of the application and follow applicable industry standards, specifications, and other technical information provided with the Product. If Seller provides Product options based upon data or specifications provided by the Buyer, the Buyer is responsible for determining that such data and specifications are suitable and sufficient for all applications and reasonably foreseeable uses of the Products. In the event the Buyer is not the end-user, Buyer will ensure such end-user complies with this paragraph.

9. **Use of Products, Indemnity by Buyer.** Buyer shall comply with all instructions, guides and specifications provided by Seller with the Products. Unauthorized Uses. If Buyer uses or resells the Products for any uses prohibited in Seller's instructions, guides or specifications, or Buyer otherwise fails to comply with Seller's instructions, guides and specifications, Buyer acknowledges that any such use, resale, or non-compliance is at Buyer's sole risk. Buyer shall indemnify, defend, and hold Seller harmless from any losses, claims, liabilities, damages, lawsuits, judgments and costs (including attorney fees and defense costs), whether for personal injury, property damage, intellectual property infringement or any other claim, brought by or incurred by Buyer, Buyer's employees, or any other person, arising out of: (a) improper selection, application, design, specification or other misuse of Products provided by Seller; (b) any act or omission, negligent or otherwise, of Buyer; (c) Seller's use of patterns, tooling, equipment, plans, drawings, designs or specifications or other information or things furnished by Buyer; (d) damage to the Products from an external cause, repair or attempted repair by anyone other than Seller, failure to follow instructions, guides and specifications provided by Seller, use with goods not provided by Seller, or opening, modifying, deconstructing or tampering with the Products for any reason; or (e) Buyer's failure to comply with these Terms. Seller shall not indemnify Buyer under any circumstance except as otherwise provided in these Terms.

Continued on next page

10. **Cancellations and Changes.** Buyer may not cancel or modify any order for any reason, except with Seller's written consent and upon terms that will indemnify, defend and hold Seller harmless against all direct, incidental and consequential loss or damage. Seller, at any time, may change Product features, specifications, designs and availability.
11. **Limitation on Assignment.** Buyer may not assign its rights or obligations without the prior written consent of Seller.
12. **Force Majeure.** Seller does not assume the risk and is not liable for delay or failure to perform any of Seller's obligations by reason of events or circumstances beyond its reasonable control ("Events of Force Majeure"). Events of Force Majeure shall include without limitation: accidents, strikes or labor disputes, acts of any government or government agency, acts of nature, delays or failures in delivery from carriers or suppliers, shortages of materials, or any other cause beyond Seller's reasonable control.
13. **Waiver and Severability.** Failure to enforce any provision of these Terms will not invalidate that provision; nor will any such failure prejudice Seller's right to enforce that provision in the future. Invalidation of any provision of these Terms by legislation or other rule of law shall not invalidate any other provision herein and, the remaining provisions will remain in full force and effect.
14. **Termination.** Seller may terminate any agreement governed by or arising from these Terms for any reason and at any time by giving Buyer thirty (30) days prior written notice. Seller may immediately terminate, in writing, if Buyer: (a) breaches any provision of these Terms (b) appoints a trustee, receiver or custodian for all or any part of Buyer's property (c) files a petition for relief in bankruptcy on its own behalf, or one if filed by a third party (d) makes an assignment for the benefit of creditors; or (e) dissolves its business or liquidates all or a majority of its assets.
15. **Ownership of Software.** Seller retains ownership of all Software supplied to Buyer hereunder. In no event shall Buyer obtain any greater right in and to the Software than a right in the nature of a license limited to the use thereof and subject to compliance with any other terms provided with the Software.
16. **Indemnity for Infringement of Intellectual Property Rights.** Seller is not liable for infringement of any patents, trademarks, copyrights, trade dress, trade secrets or similar rights ("Intellectual Property Rights") except as provided in this Section. Seller will defend at its expense and will pay the cost of any settlement or damages awarded in an action brought against Buyer based on a third party claim that one or more of the Products sold hereunder infringes the Intellectual Property Rights of a third party in the country of delivery of the Products by the Seller to the Buyer. Seller's obligation to defend and indemnify Buyer is contingent on Buyer notifying Seller within ten (10) days after Buyer becomes aware of any such claim, and Seller having sole control over the defense of the claim including all negotiations for settlement or compromise. If one or more Products sold hereunder is subject to such a claim, Seller may, at its sole expense and option, procure for Buyer the right to continue using the Products, replace or modify the Products so as to render them non-infringing, or offer to accept return of the Products and refund the purchase price less a reasonable allowance for depreciation. Seller has no obligation or liability for any claim of infringement: (i) arising from information provided by Buyer; or (ii) directed to any Products provided hereunder for which the designs are specified in whole or part by Buyer; or (iii) resulting from the modification, combination or use in a system of any Products provided hereunder. The foregoing provisions of this Section constitute Seller's sole and exclusive liability and Buyer's sole and exclusive remedy for such claims of infringement of Intellectual Property Rights.
17. **Governing Law.** These Terms and the sale and delivery of all Products are deemed to have taken place in, and shall be governed and construed in accordance with, the laws of the State of Ohio, as applicable to contracts executed and wholly performed therein and without regard to conflicts of laws principles. Buyer irrevocably agrees and consents to the exclusive jurisdiction and venue of the courts of Cuyahoga County, Ohio with respect to any dispute, controversy or claim arising out of or relating to the sale and delivery of the Products.
18. **Entire Agreement.** These Terms, along with the terms set forth in the main body of any Quote, forms the entire agreement between the Buyer and Seller and constitutes the final, complete and exclusive

expression of the terms of sale. In the event of a conflict between any term set forth in the main body of a Quote and these Terms, the terms set forth in the main body of the Quote shall prevail. All prior or contemporaneous written or oral agreements or negotiations with respect to the subject matter shall have no effect. These Terms may not be modified unless in writing and signed by an authorized representative of Seller.

19. **Compliance with Laws.** Buyer agrees to comply with all applicable laws, regulations, and industry and professional standards, including those of the United States of America, and the country or countries in which Buyer may operate, including without limitation the U.S. Foreign Corrupt Practices Act ("FCPA"), the U.S. Anti-Kickback Act ("Anti-Kickback Act"), U.S. and E.U. export control and sanctions laws ("Export Laws"), the U.S. Food Drug and Cosmetic Act ("FDCA"), and the rules and regulations promulgated by the U.S. Food and Drug Administration ("FDA"), each as currently amended. Buyer agrees to indemnify, defend, and hold harmless Seller from the consequences of any violation of such laws, regulations and standards by Buyer, its employees or agents. Buyer acknowledges that it is familiar with all applicable provisions of the FCPA, the Anti-Kickback Act, Export Laws, the FDCA and the FDA and certifies that Buyer will adhere to the requirements thereof and not take any action that would make Seller violate such requirements. Buyer represents and agrees that Buyer will not make any payment or give anything of value, directly or indirectly, to any governmental official, foreign political party or official thereof, candidate for foreign political office, or commercial entity or person, for any improper purpose, including the purpose of influencing such person to purchase Products or otherwise benefit the business of Seller. Buyer further represents and agrees that it will not receive, use, service, transfer or ship any Product from Seller in a manner or for a purpose that violates Export Laws or would cause Seller to be in violation of Export Laws.

5/2017

A Hose

B Tubing Thermoplastic

C Coiled Air Hose & Fittings

D Transportation

E Fittings

F Tooling, Equipment & Accessories

G General Technical

Part Number Index pg. 1

A Hose

B Tubing
Thermoplastic

C Coiled Air Hose
& Fittings

D Transportation

M Fittings

T Tooling, Equipment,
& Accessories

G General Technical

| Part Number | Page | Part Number | Page | Part Number | Page | Part Number | Page |
|----------------|---------------|-------------|------|-------------|------|-------------------|------|
| 015301 | F-5, F-8, F13 | 10695 | E-64 | 17991N | E-57 | 1J9CY | E-79 |
| 015302 | F-8, F-9 | | | 19256 | E-43 | | |
| 015303 | F-8, F-9 | 106CG | E-73 | 19291N | E-60 | 1JBSF | E-81 |
| 015304 | F-8, F-9 | 106CY | E-78 | | | | |
| 015305 | F-8, F-9 | 106SF | E-81 | 1AL56 | E-44 | 1JC56 | E-40 |
| 015306 | F-6, F-8 | | | 1AL91N | E-57 | 1JC91N | E-59 |
| 015307 | F-6 | 10756 | E-36 | 1ALCG | E-74 | 1JC93N | E-63 |
| 015308 | F-6 | 10791N | E-53 | | | 1JCCG | E-76 |
| 015309 | F-6 | 107CG | E-74 | 1B156 | E-44 | 1JCCY | E-78 |
| 015310 | F-8, F-9 | | | 1B256 | E-44 | | |
| 015411 | F-8, F-9 | 10856 | E-37 | 1B291 | E-60 | 1JS56 | E-41 |
| 015412 | F-8, F-9 | 10891N | E-53 | | | 1JSCG | E-76 |
| 015413 | F-8, F-9 | 108MS | E-80 | 1C356 | E-45 | 1JSSF | E-81 |
| 015414 | F-8, F-9 | | | 1C456 | E-45 | 1L956 | E-39 |
| 015415 | F-8, F-9 | 10C56 | E-43 | 1C556 | E-45 | 1L9CG | E-76 |
| 015736 | F-6 | | | 1C656 | E-46 | | |
| | | 1120 | D-5 | 1C956 | E-46 | 1LMCY | E-79 |
| 025349 | F-6, F-9 | | | 1CA56 | E-47 | 1P691N | E-57 |
| 025399 | F-5, F-9, F13 | 11356 | E-37 | 1CE56 | E-47 | 1PCDY | E-79 |
| 025411 | F-5 | 113CY | E-78 | 1CF56 | E-48 | | |
| | | 11C56 | E-43 | | | 1TFMS | E-80 |
| 101-(PTFE) | B-44 | | | 1D056 | E-49 | 1TU56 | E-42 |
| 10156 | E-34 | 12891N | E-54 | 1D256 | E-49 | 1TU91N | E-59 |
| 10191N | E-52 | 12892 | E-61 | 1D956 | E-49 | 1TUCG | E-76 |
| 10193N | E-62 | | | | | | |
| 101CG | E-72 | 13491N | E-54 | 1FU56 | E-48 | 1WU56 | E-50 |
| 101CY | E-77 | 134MS | E-80 | 1FUOG | E-75 | 1WW56 | E-50 |
| 101SF | E-81 | | | | | 1WY56 | E-50 |
| 101SQ | E-82 | 13756 | E-38 | 1GKCY | E-79 | | |
| | | 13791N | E-54 | 1GK91N | E-60 | 201-(Metric PTFE) | B-44 |
| 10256 | E-34 | 13793N | E-62 | | | 20151 | E-22 |
| 102CG | E-73 | 137CG | E-74 | 1HUSQ | E-82 | 20151R | E-24 |
| 102CY | E-77 | | | | | | |
| | | 13956 | E-38 | 1J056 | E-40 | 20190 | E-26 |
| 103-(FEP) | B-66 | 13991N | E-55 | 1J0CG | E-75 | 201BU | E-31 |
| 10356 | E-35 | 13993N | E-63 | | | | |
| 1035HT | A-57 | 139CG | E-74 | 1J156 | E-40 | 203-(Metric FEP) | B-66 |
| 10391N | E-52 | 139CY | E-78 | 1J191N | E-58 | 20351 | E-22 |
| 103CG | E-73 | | | | | 20351R | E-24 |
| | | 13E56 | E-37 | 1J256 | E-41 | | |
| 104-(PFA) | B-76 | | | 1J556 | E-41 | | |
| 10456 | E-35 | 14156 | E-39 | 1J756 | E-42 | | |
| | | 14191N | E-55 | 1J791N | E-58 | | |
| 105-(H.P. PFA) | B-76 | 14956 | E-39 | 1J793N | E-63 | | |
| 10556 | E-35 | 16191N | E-55 | 1J7CG | E-75 | | |
| 105CG | E-73 | 16791N | E-56 | | | | |
| 10656 | E-36 | 16792 | E-61 | 1J956 | E-42 | | |
| 10691N | E-52 | 16991N | E-56 | 1J991N | E-59 | | |
| 10691NRD | E-53 | 16992 | E-61 | 1J993N | E-63 | | |
| 10693N | E-62 | | | 1J9CG | E-75 | | |
| 10694 | E-64 | 17791N | E-56 | | | | |

Part Number Index pg. 2

| Part Number | Page | Part Number | Page | Part Number | Page | Part Number | Page |
|-----------------------|------------|------------------|----------|-------------------|------------|---------------------|------------|
| 204-(Metric PFA) | B-77 | 538DM | A-51 | 8LPG | A-61 | 94C-080-PFD | F-4 |
| | | 540N | A-49 | 811537 | D-10 | 94C-001-PFD | F-4 |
| 205-(Metric H.P. PFA) | B-78 | 540P | A-50 | 81914/1 | B-65 | 94C-002-PFD | F-4 |
| | | | | 81914/2 | B-65 | 94C-MKS | F-6 |
| 20651 | E-23 | 55LT | A-52 | 81914/3 | B-74 | | |
| 20651R | E-25 | | | 81914/4 | B-74 | 944B | A-75 |
| 20690 | E-27 | 55SG | F-17 | | | | |
| 206BU | E-31 | 55SSG | F-16 | 822011 | F-8, F-9 | 95FR | B-39 |
| | | | | 822012 | F-8, F-9 | 955B | A-76 |
| 20851 | E-23 | 5PSG | F-16 | 822031 | F-8, F-9 | 95U | B-37 |
| 20890 | E-27 | | | | | 95UM | B-37 |
| 208MS | E-32 | 56DH | A-53 | 82C-061L-PFD | F-10 | 95UFS | C-7 |
| | | | | 82C-0AP-PFD | F-13 | | |
| 213BU | E-31 | 560TJ | A-38 | 82C-CHD-PFD | F-10 | 9A | A-82 |
| | | 563LT | A-40 | 82C-KKB-PFD | F-10 | 9M | A-82 |
| 2245N | A-98 | 563TJ | A-39 | 82C-R01-PFD | F-10 | 9P | A-82 |
| 22890 | E-27 | | | F4; F-8-F-10; F15 | | | |
| | | 575X | A-54 | 82C-R02-PFD | F-10 | A0 | C-4 |
| 23490 | E-28 | 575XN | A-54 | | | AS-Y | F-17 |
| 23790 | E-28 | | | 83C-080-PFD | F-12 | | |
| 23951 | E-23 | 580661-PFD | F-19 | 83C-081-PFD | F-12 | B9 | A-58 |
| 23990 | E-28 | 580N | A-55 | 83C-0CB-PFD | F-12 | | |
| | | 588N | A-55 | 83C-R02-PFD | F-12 | CL | E-66 |
| 24398-PFD | F-19 | | | 83C-R02H-PFD | F-12 | | |
| | | 590TJ | A-41 | 83C-S40-PFD | F-12 | CNGG | F-16 |
| 2613 | F-17 | 594TJ | A-42 | 83C-S20-PFD | F-12 | CNGRP | A-60 |
| | | | | | | | |
| 26190 | E-29 | 5CNG | A-59 | 83FR | A-56 | CR | B-74 |
| 26790 | E-29 | 5CNG/5CNGLT | F-16 | | | CV | B-63; B-72 |
| 26990 | E-29 | | | 85C-00L-PFD | F-10, F-11 | CVL | B-63 |
| | | 6-2 CTX-S | F-9 | 85C-061L-PFD | F-11 | CVH | B-63 |
| 27790 | E-30 | 6-6 CTX-S | F-8, F-9 | 85C-0HP-PFD | F-13 | | |
| 27990 | E-30 | | | 85C-OEP-PFD | F-13 | CY02-652317 | E-79 |
| | | 68NTA | D-10 | 85C-1PH-PFD | F-10, F-11 | | |
| 2GK-Nut | E-60; E-79 | 685RA | E-50 | 85C-CHD-PFD | F-11 | D6R | A-32 |
| 2JS51R | E-25 | | | 85C-KKB-PFD | F-11 | D6RX | A-32 |
| 2TFMS | E-32 | 703 | C-9 | 85C-R01-PFD | F-11, F-15 | | |
| | | 704 | C-9 | 85C-R02-PFD | F-11 | E | B-20 |
| | | 705 | C-9 | 85C-STD-PFD | F-10, F-11 | E Male Cam & Groove | E-67 |
| 3PSG | F-16 | | | | | EB | B-20 |
| 3PSG-4 | E-70 | 731512-Blue, Red | D-9 | 881540-PFD | F-19 | | |
| | | 731513-Blue, Red | D-9 | | | FBS | E-67 |
| 510C | A-43 | 731516 | D-9 | 919/919B | A-69 | FIL | E-68 |
| 510D | A-44 | 731522 | D-9 | 919BJ | A-70 | FJX | E-69 |
| | | 731612-Blue, Red | D-9 | 919J | A-70 | FORFS | E-69 |
| | | | | 919U | A-71 | | |
| 518C | A-45 | | | 929/929B | A-72 | | |
| 518D | A-46 | 741526 | D-9 | 929BJ | A-73 | | |
| 520N | A-47 | 741590-Blue, Red | D-9 | | | | |
| 527BA | A-48 | 751641 | D-9 | 939/939B | A-74 | | |
| 528N | A-47 | | | | | | |
| 53DM | A-51 | 771164 | D-9 | | | | |

A Hose

B Tubing Thermoplastic

C Coiled Air Hose & Fittings

D Transportation

E Fittings

F Tooling, Equipment & Accessories

G General Technical

Part Number Index pg. 3

A Hose

B Tubing
Thermoplastic

C Coiled Air Hose
& Fittings

D Transportation

E Fittings

F Tooling, Equipment,
& Accessories

G General Technical

| Part Number | Page | Part Number | Page | Part Number | Page |
|--------------------------|------|----------------------|------------|------------------|------|
| FP | E-68 | N | B-28-30 | SC300 | E-66 |
| FS | F-17 | NA-6520 | E-60; E-79 | SCB | A-78 |
| GH9211 | D-9 | NB | B-28-30 | SCBV | A-79 |
| GH9212 | D-9 | NBR | B-34 | SCW | A-78 |
| H6 | A-35 | NCB | A-81 | SCWV | A-79 |
| HBR | F-16 | NCW | A-81 | SFR | E-71 |
| HDPE | B-25 | NN | B-28-30 | SQ-101-SW | F-14 |
| HFSR | A-33 | NNR | B-34 | SQ Mender | F-14 |
| HFS2R | A-34 | NR | B-33 | ST300 | E-66 |
| HLB | A-62 | PAT | B-32 | STB | A-77 |
| HS1.25FEP | B-70 | PCB | A-80 | STW | A-77 |
| HS1.3FEP | B-68 | PCW | A-80 | TFB | B-53 |
| HS1.6FEP | B-68 | PC300 | E-66 | TFH, AWG | B-48 |
| HS2TFI | B-57 | PEFR | B-24 | TFL, AWG | B-51 |
| HS2TFL, AWG | B-57 | PF ANSI Flange | E-70 | TFS, AWG | B-49 |
| HS2TFL, Fractional | B-57 | PF150 | E-70 | TFT, AWG | B-50 |
| HS2TFS, AWG | B-58 | PF154 | E-70 | TH11-1-PFD | F-19 |
| HS2TFS, Fractional | B-57 | PF156 | E-70 | TH9-1-XXX | F-15 |
| HS2TFT, AWG | B-59 | PJ/PJH | B-79 | TSWTF | B-55 |
| HS2TFT, Fractional | B-57 | PLCF | E-70 | TUBE | E-70 |
| HS4TFI | B-61 | PP | B-36 | VBL | F-15 |
| HTB/HTBR | A-37 | PPB | B-36 | VBS | F-15 |
| HTC | F-19 | PSG | F-16; F-18 | | |
| HTFL | D-7 | PST | F-19 | | |
| MBS | E-67 | PTC | F-20 | | |
| MC | C-5 | PTC-001-RB | F-20 | | |
| MIL | E-68 | PTH | A-65 | | |
| ML | C-5 | PV (guard) | F-16 | | |
| MP | E-69 | PV (tubing) | B-41 | | |
| MSAN | E-71 | R6 | A-36 | | |
| MSH | A-63 | S5N | A-66 | | |
| MSXL | A-64 | S6 | A-67 | | |
| | | S9 | A-68 | | |
| | | SAN | E-71 | | |

Key Word Index pg. 1

| Part | Page | Part | Page | Part | Page |
|--|------------------|---|------------|-------------------------------------|------------|
| 1.25/1 Heat Shrink | B-71 | Fast Response Hose (575x)..... | A-54 | Parkrimp 2..... | F-12 |
| 1.3/1 Heat Shrink | B-69 | Fast-Stor® Air Hose | C-4 | Partek Sleeve..... | F-17 |
| 1.67/1 Heat Shrink | B-69 | Fast-Stor® Fittings..... | C-5 | PFA Tubing | B-77 |
| 2:1 Heat Shrink..... | B-56 | FEP Heat Shrink | B-69 | polyflex Hose | A-84 |
| 4:1 Heat Shrink..... | B-61 | FEP Tubing | B-66 | Polyethylene Tubing | B-22 |
| 51 Series..... | E-22 | Field Attachable Fitting..... | E-22 | Polypropylene Tubing | B-35 |
| 51R Series | E-24 | Fifth Wheel Slider | D-10 | Polyurethane Tubing..... | B-37 |
| 56 Series | E-33 | | | Power Cleaning Hose | A-57 |
| 90 Series | E-26 | Fire Sleeve | F-17 | Predator® (S5, S6, S9)..... | A66:A-68 |
| 91N Series | E-51 | Flange | E-70 | PTFE Beading | B-52 |
| 92 Series | E-61 | Flange Retainer..... | E-71 | PTFE Heat Shrink..... | B-56 |
| 93N Series | E-62 | Flare-Seal Hose | A-79 | PTFE Hose..... | A-69 |
| 94 Series | E-64 | Fluoropolymer Retractable Coils | C-8 | PTFE Spiral Wrap..... | B-54 |
| 95 Series | E-64 | Fluoropolymer Tubing..... | B-44 | PTFE Tubing..... | B-44 |
| | | Grease Zerk Fitting | E-60; E-79 | Pumps (Crimpers)..... | F-13 |
| A-LOK® Fitting | E-57; E-70; E-74 | Guards..... | F-18 | Pure Air Tubing..... | B-31 |
| Abrasion King® (R6)..... | A-36 | | | Rapid Assy Fitting..... | E-50 |
| Adapter..... | E-50 | Harnesses | D-11 | Replacement Parts (MiniKrimp) | F-8 |
| Air Brake Tubing | D-5 | Heat Shrink Tubing | B-56; B-69 | Roll Cover | B-71 |
| Air Hose..... | C-4 | Heavy Wall PTFE Hose..... | A-72; A-79 | SCR Hose | D-12 |
| AWG Tubing..... | B-47 | High Density Tubing | B-25 | | |
| | | High Purity Tubing | B-78 | Sewer Hose | A-66 |
| Bend Restrictor..... | F-16 | Hose Cutter | F-19 | SF Series | E-81 |
| Brakcoil | D-9 | Hose Guard | F-16 | Skive Tool | F-20 |
| Breathing Air Hose..... | A-48 | Insertion Block..... | F-15 | SQ Series..... | E-82 |
| BU Series..... | E-31 | | | Swager | F-14 |
| Bulkhead Nut | E-60 | Karrykrimp..... | F-10 | Table Mount..... | F-6 |
| Bundles | D-11 | Karrykrimp 2..... | F-11 | TOUGHJACKET™ Hose..... | A-38: A-41 |
| | | | | Tube Cutter | F-20 |
| CG Series | E-72 | Low Temperature Hose (55LT) | A-52 | Vinyl Tubing..... | B-41 |
| Clear Vinyl Hose Guard..... | F-16 | Lubrication Line Hose (HLB)..... | A-62 | Vise Blocks..... | F-15 |
| Clear Vinyl Tubing..... | B-41 | | | | |
| Collars..... | E-66 | Marine Hose (MSH) | A-63 | | |
| Convolutd Hose | A-73 : A-79 | Metal Hose | A-99 | | |
| Convolutd Tubing..... | B-62; B-73 | Microweld | B-39 | | |
| Corrugated Tubing..... | B-75 | MiniKrimp..... | F-4 | | |
| Crimp Fittings | E-33 | Mounts | F-6 | | |
| Crimpers/Crimping Machines | F-4 | MS Series | E-80 | | |
| Cut-off Tools..... | F-19 | Multitube® Bundles..... | A-84, B-79 | | |
| CY Series | E-77 | NoMar® Fast-Stor® Coil Assy | C-7 | | |
| | | Non-Conductive Hose 518D, 528N, 538DM, 588N A-46: A-47, A-51, A-55 | | | |
| Diagnostic Hose | A-53 | Nylon Air Brake Tubing | D-5 | | |
| Dies | F-15 | Nylon Tubing..... | B-27 | | |
| Diesel Fuel Tubing | D-7 | | | | |
| DuraGard™ (83FR) | A-56 | PAGE Fittings..... | E-65 | | |
| Duramax™ (53DM)..... | A-51 | Parkrimp Dies | F-15 | | |
| Elec. Conductive Compressed Nat. Gas Hose | A-59; A-60 | | | | |
| Eliminator® (HTB/HTBR) | A-37 | | | | |

A Hose

B Tubing
Thermoplastic

C Coiled Air Hose
& Fittings

D Transportation

E Fittings

F Tooling, Equipment
& Accessories

G General Technical

Key Word Index pg. 2

A Hose

B Tubing Thermoplastic

C Coiled Air Hose & Fittings

D Transportation

E Fittings

F Tooling, Equipment, & Accessories

G General Technical

| Product | Page | Product | Page |
|--|------|---|------|
| TECHNICAL DATA | | TECHNICAL DATA | |
| AIR HOSE | | PTFE Hose Chemical Resistance | A-8 |
| Air Hose Durometer | C-3 | Selection, Installation Maintenance | A-27 |
| | | Selection of Hose Diameter | A-18 |
| | | Swaged Assembly | G-15 |
| | | Stamped Form | A-19 |
| FITTINGS | | | |
| British Standard Pipe | E-14 | Twin/Multi-Line Hose Separation | G-17 |
| Fitting Configurations | E-5 | Volumetric Expansion of Hose | A-26 |
| Fitting Thread Guide for Hose | E-18 | | |
| German DIN Thread Types | E-13 | TUBING | |
| Hose Fitting Insertion Values | E-10 | Compatibility Chart for Fittings. | B-8 |
| Identifying Fitting Types | E-11 | Fluoropolymer Chemical Resistance | B-5 |
| Japanese Fittings | E-17 | Material Property Overview..... | B-4 |
| Media to Fitting Compatibility | E-20 | Materials..... | B-10 |
| Metals Corrosion Scale | E-21 | Material Compatibility Guide | B-11 |
| | | Nomenclature | B-14 |
| Nomenclature | E-4 | Pressure Ranges | B-7 |
| North American Thread Types | E-15 | Specifications | B-6 |
| Pressure Rating- End Connections | E-8 | | |
| Sanitary Sizing | E-6 | | |
| | | | |
| Thread Type (Determining) | E-12 | | |
| HOSE | | | |
| Agency Specifications | A-7 | | |
| Assembly & Crimping | G-3 | | |
| Calculation of Hose Length | A-19 | | |
| | | | |
| Compatibility Guide Media/Hose | | | |
| Material | A-22 | | |
| Construction/Specs, Thermoplastic Hose psi | | | |
| | A-10 | | |
| Construction/Specs, Thermoplastic Hose MPa | | | |
| | A-14 | | |
| Construction/Specs, PTFE Hose psi | | | |
| | A-12 | | |
| Construction/Specs, PTFE Hose psi MPa | | | |
| | A-16 | | |
| | | | |
| Hose Constructions | A-9 | | |
| Material Features..... | A-20 | | |
| Material Overview | A-21 | | |
| Nomenclature | A-29 | | |

A Hose

B Tubing
Thermoplastic

C Coiled Air Hose
& Fittings

D Transportation

E Fittings

F Tooling, Equipment
& Accessories

G General Technical

Parker Fluid Connectors Group

North American Divisions & Distribution Service Centers

Your complete source for quality tube fittings, hose & hose fittings, brass & composite fittings, quick-disconnect couplings, valves and assembly tools, locally available from a worldwide network of authorized distributors.

Fittings:

Available in inch and metric sizes covering SAE, BSP, DIN, GAZ, JIS and ISO thread configurations, manufactured from steel, stainless steel, brass, aluminum, nylon and thermoplastic.

Hose, Tubing and Bundles:

Available in a wide variety of sizes and materials including rubber, wire-reinforced, thermoplastic, hybrid and custom compounds.

Worldwide Availability:

Parker operates Fluid Connectors manufacturing locations and sales offices throughout North America, South America, Europe and Asia-Pacific.

For information, call toll free...

1-800-C-PARKER

North American Divisions

Fluid System Connectors Division

Otsego, MI
phone 269 694 9411
fax 269 694 4614

Hose Products Division

Wickliffe, OH
phone 440 943 5700
fax 440 943 3129

Industrial Hose Division

Wickliffe, OH
phone 440 833 2120
fax 440 833 2230

Parflex Division

Ravenna, OH
phone 330 296 2871
fax 330 296 8433

Quick Coupling Division

Minneapolis, MN
phone 763 544 7781
fax 763 544 3418

Tube Fittings Division

Columbus, OH
phone 614 279 7070
fax 614 279 7685

Distribution Service Centers

Buena Park, CA

phone 714 522 8840
fax 714 994 1183

Conyers, GA

phone 770 929 0330
fax 770 929 0230

Louisville, KY

phone 502 937 1322
fax 502 937 4180

Portland, OR

phone 503 283 1020
fax 503 283 2201

Toledo, OH

phone 419 878 7000
fax 419 878 7001
fax 419 878 7420
(FCG Kit Operations)

Canada

Milton, ONT

phone 905 693 3000
fax 905 876 1958
(Contact Grimsby for other Service Center locations.)

Mexico

Toluca, MEX

phone (52) 722 2754 200
fax (52) 722 2722 168

